



**IEA**  
SOLAR R&D

**INTERNATIONAL ENERGY AGENCY**

solar heating and  
cooling programme

task VII

# **central solar heating plants with seasonal storage**

**basic design data for the  
heat distribution system**

october 1982

## INTERNATIONAL ENERGY AGENCY

In order to strengthen co-operation in the vital area of energy policy, an Agreement on an International Energy Programme was formulated among a number of industrialized countries in November 1974. The International Energy Agency (IEA) was established as an autonomous body within the Organization for Economic Co-operation and Development (OECD) to administer that agreement. Twenty countries are currently members of the IEA, with the Commission of the European Communities participating under a special arrangement.

As one element of the International Energy Programme, the participants undertake co-operative activities in energy research, development, and demonstration. A number of new and improved energy technologies which have the potential of making significant contributions to our energy needs were identified for collaborative efforts. The IEA Committee on Energy Research and Development (CRD), assisted by a small Secretariat, co-ordinates the energy research, development, and demonstration programme.

### Solar heating and cooling programme

Solar Heating and Cooling was one of the technologies selected by the IEA for a collaborative effort. The objective was to undertake co-operative research, development, demonstrations and exchanges of information in order to advance the activities of all Participants in the field of solar heating and cooling. Several tasks were developed in key areas of solar heating and cooling. A formal Implementing Agreement for this Programme, covering the contributions, obligations and rights of the Participants, as well as the scope of each task, was prepared and signed by 15 (now 20) countries and the Commission of the European Communities. The overall programme is managed by an Executive Committee, while the management of the tasks is the responsibility of Operating Agents who act on behalf of the other Participants.

*The task of the IEA Solar Heating and Cooling Programme and their respective Operating Agents are:*

- I Investigation of the Performance of Solar Heating and Cooling Systems – Technical University of Denmark
- II Co-ordination of R & D on Solar Heating and Cooling Components – Agency of Industrial Science and Technology, Japan
- III Performance Testing of Solar Collectors – Kernforschungsanlage Jülich, Federal Republic of Germany
- IV Development of an Insolation Handbook and Instrumentation Package – United States Department of Energy
- V Use of Existing Meteorological Information for Solar Energy Application – Swedish Meteorological and Hydrological Institute
- VI Performance of Solar Heating, Cooling and Hot Water Systems Using Evacuated Collectors – United States Department of Energy
- VII Central Solar Heating Plants with Seasonal Storage – Swedish Council for Building Research
- VIII Passive and Hybrid Solar Low Energy Buildings – United States Department of Energy

Collaboration in additional areas is likely to be considered as projects are completed or fruitful topics for co-operation identified.

### Task VII – Central Solar Heating Plants with Seasonal Storage: Feasibility Study and Design

In colder climates solar energy for heating of buildings is least abundant when it is needed most – during the winter. A seasonal storage is needed for making solar heat gained during warmer months available for later use. From investigations of various storage methods two observations can be made: The choice of storage method will greatly influence the working conditions for and the optimal choice of the solar collectors and the heat distribution system; and based on the technique that is available today the most economic solutions will be found in large applications. The objective of Task VII is to determine the technical feasibility and cost-effectiveness of such seasonal solar energy storage for large-scale district heating systems. The Participants will evaluate the merits of various components and system configurations for collecting, storing and distributing the energy, and prepare site-specific designs for specific systems.

*The work is divided in two phases, preliminary design and detailed design. The work during the first phase is undertaken in five Subtasks:*

- Subtask I a) System Studies and Optimization (Lead Country: Canada)
- Subtask I b) Solar Collector Subsystems (Lead Country: USA)
- Subtask I c) Heat Storage (Lead Country: Switzerland)
- Subtask I d) Heat Distribution System (Lead Country: Sweden)
- Subtask I e) Inventory and Preliminary Site Specific System Design (Lead Country: Sweden)

The Participants in this Task are Austria, Canada, the Commission of European Communities, Denmark, Germany, the Netherlands, Sweden, Switzerland, the United Kingdom and the United States.

This report documents work carried out under Subtask I d) of this Task. The co-operative work and resulting report is described in the following section.

# **central solar heating plants with seasonal storage**

## **basic design data for the heat distribution system**

**Tomas Bruce**  
Södertälje Energy Supply Authority, Sweden

**Lennart Lindeberg**  
**Stefan Roslund**  
ÅF-Energikonsult, Sweden

October 1982

---

This report is part of the work within the IEA Solar Heating and Cooling Programme,  
Task VII: Central Solar Heating Plants with Seasonal Storage  
Subtask 1 d): Heat Distribution System

---

Restricted distribution: only for distribution to the Participants in task VII.

D22:1982

ISBN 91-540-3819-7

Swedish Council for Building Research, Stockholm, Sweden

Spångbergs Tryckerier AB, Stockholm 1982

TABLE OF CONTENTS

	<u>Page no</u>
1. INTRODUCTION	5
2. ENERGY DISTRIBUTION BY MEANS OF HOT WATER IN PARTICIPATING COUNTRIES	7
- Review of District Heating	
- Review of Computer Programs	
- Codes and Standards	
- Application for CSHPSS	
2.1 Austria	7
2.2 Canada	11
2.3 Denmark	14
2.4 Italy	15
2.5 Federal Republic of Germany	16
2.6 The Netherlands	21
2.7 Sweden	24
2.8 Switzerland	28
2.9 United Kingdom	32
2.10 United States of America	36
3. BASIC ASSUMPTIONS FOR THE HEAT DISTRIBUTION IN A CENTRAL SOLAR HEATING PLANT WITH SEASONAL STORAGE (CSHPSS)	40
3.1 General matters	40
3.2 Transmission from solar collectors to storage	41
3.3 Distribution from storage to consumers	41
3.4 Consumer installations	42
3.5 The designing procedure	43

	<u>Page no</u>	
4.	COLLECTION OF DATA	46
4.1	General conditions	46
4.2	Piping	47
4.2.1	Steel pipes	47
4.2.2	Copper pipes	48
4.2.3	Other pipe materials	48
4.2.4	Multi-pipe culvert	49
4.2.5	Temperature limits	49
4.3	Heat exchangers	50
4.4	Pumps	51
4.5	Heat meters	52
4.6	Heat losses	52
4.6.1	Momentary heat losses	53
4.6.2	Annual losses of thermal energy	59
4.6.3	Cost for pipeline insulation	60
	 ATTACHMENTS	
	A. Dimensioning of district heating piping systems	61
	B. Survey of costs, steel pipes	87
	C. Survey of costs, copper pipes	91
	D. Survey of costs, pipes made of other materials	93
	E. Survey of costs, multi-pipe culvert	96
	F. Survey of costs, heat exchangers	97
	G. Survey of costs, pumps	99
	H. Survey of costs, heat meters	102
	 LIST OF PARTICIPANTS	104

## 1. INTRODUCTION

The distribution of heat is an essential part of all centralized heating systems. The bigger the system is, the more important is the design of the distribution. The use of district heating for heating of whole cities is today common in many countries and is spreading to others. Thus a considerable amount of experience has been gathered. This experience is valuable when developing central solar heating plants, although these new plants are unable to cover whole cities. A widely used distribution technique can be a big help when developing new concepts, even when the technique has to be adapted.

The primary purpose of the distribution subtask is to provide significant technical and economical data for the design of central solar heating plants. A secondary purpose is to transfer knowledge about heat distribution by means of hot water to countries where the use of district heating is not so common. We have found that broadening our subtask report in this field increases the value of the report. Thus we hope that part of the information given here will be of use for other applications as well as solar plants.

The distribution system in a CSHPSS interconnects solar collectors with heat storage and heat storage with consumers. The distribution system starts at the point where the heat from all solar collectors is concentrated, does not include auxiliary equipment for the heat storage and ends where the heat is delivered to connected buildings. It comprises all necessary equipment such as pumps, compensators, valves, heat meters etc.

Hot water is the only method of heat distribution considered.

The definition of district heating varies to some extent between participating countries. In Germany, Denmark and Sweden it often means heating whole cities, whereas in the United Kingdom it often is used to mean the heating of a group of buildings in a city. In spite of the scale, the technique is basically the same.

This report is a result of a co-operative effort of all participating countries. The different contributions have been put together, the general parts edited and the cost analysis performed by Sweden as the Lead Country. The report has been reviewed at working meetings and edited for language clarity by the UK participant.

The European Community (EC) has been participating in the Task. EC has chosen Italy as its practical case.

Opinions expressed in the report do not necessarily represent official national standpoints.



## 2. ENERGY DISTRIBUTION BY MEANS OF HOT WATER IN PARTICIPATING COUNTRIES

A country by country survey of the current state of district heating is given below. Emphasis is placed on the following items:

- \* The state of development of district heating in general.
- \* Review of computer programs for design and simulation of district heating systems available in each country.
- \* Survey of the most important codes and standards applicable to the design and construction of district heating systems.
- \* Description of the most suitable CSH PSS applications in each country.

This review of the status of district heating has been carried out by putting together the contributions from each country.

### 2.1 AUSTRIA

#### 2.1.1 Review of District Heating in Austria

Currently there are in Austria 45 combined heat and power stations operating. In the year 1980 these plants delivered a total heat quantity of about 4 500 GWh to the district heating network. After losing about 11 percent the system delivered 4 000 GWh to the consumers. The installed thermal peak power amounted to 2 800 MW of which 40% or about 1 120 MW stem from combined plants.

The primary network has a length of more than 560 kilometers whereby the average consumer density in the existing supply districts - in order of magnitude - is between 1 and 8 MW/km. The average supply rate for the total distribution network is 5.2 MW/km of piping.

The development study for long distance heat supply made by the engineering committee of the gas and heat supply business for the years 1981 through 1991 predicts total investment costs of around 10 billion Austrian Schillings - this at the price rates of 1979. 14% of this amount is for district heating plants, and 35% for power plants, where priority is given for the power-heating-coupling. The left over 50% is for heat distribution which includes the district heating network and the necessary transfer stations. The advantage of central heat production is therefore diminished by the disadvantage of expensive infra structures.

The efficiency of all long distance heat supply systems depends strongly on the consumer density near the network. The connection as yet is only on a voluntary basis. There are no laws at the moment that force connection to the network. The possibility of forcing someone through regional regulations could lead to constitutional deliberations. A federal law to force connection in district heating supplied areas is in preparation and has been discussed in the parliament.

#### 2.1.2 Review of Computer Programs available in Austria

ROHRNET: Program for the optimization of the long distance heat pipeline dimensions (economy curves)

ISOPT: Program for the optimization of the insulation material's efficiency (economy curves)

Both are internal programs of the "Österreichische Rohrbau Ges.m.b.H.".

### 2.1.3 Codes and Standards in Austria

ÖNORM B 8110 Building construction, heat insulation.

ÖNORM B 8110 Supplement 1, climate chart for the application of ÖNORM:s B 8110 heat insulation building constructions.

ÖNORM M 7500 Part 1 to 5, heatload of buildings; principles, construction data.

#### Under preparation (designs)

ÖNORM B 8131 Closed water heating system; executing and security regulations.

ÖNORM B 8135 Simplified calculation of heatload of buildings respectively calculation of heat loss.

Supplement, proof of the calculated total heat loss and proof of heat load.

#### Relevant technical contract regulations

ÖNORM B 2203 Underground working - guidelines and contract regulations.

ÖNORM B 2205 Soil working.

ÖNORM B 2209 Seal with bituminous material to stop the ingress of water.

ÖNORM B 2260 Cold and heat insulation installations.

ÖNORM B 2301 Concrete and reinforced concrete, notations.

ÖNORM B 2503 Street canals.

ÖNORM B 3305 Concrete aggressive water,soils and gases.

ÖNORM B 4000 Measuring and construction of the supporting  
framework.

ÖNORM B 5070 Concrete pipes.

ÖNORM M 5611 Medium heavy coiled pipes.

ÖNORM M 5612 Heavy coiled pipes.

ÖNORM M 5620 Welded pipes.  
5623

ÖNORM M 5625 Welded steel pipes.

ÖNORM M 5691 Seamless steel pipes - welding arch.

ÖNORM M 5692 Seamless steel pipes - welding arch.

ÖNORM M 7301 Reinforcement in pressure vessels and  
pressure reservoirs.

ÖNORM M 7802 Welding preparation for steel pipes.

DIN 17175 Seamless pipes made of heat resisting steels.

DIN 30670 Polyethylene jacketing of steel pipes for gas  
and water.

#### 2.1.4 Application for CSHPSS in Austria

There are no solar heating plants for larger than single family houses operating in Austria. The first large seasonal-storage-concept is to be designed for the military building in Innsbruck-Kranebitten (Test case in subtask 1e).

## 2.2 CANADA

### 2.2.1 Review of District Heating in Canada

The two largest users of district heating in Canada are Public Works Canada (PWC), the Federal Government department responsible for federally owned buildings and the Department of National Defence.

District heating systems operated by PWC to provide heat for public buildings are, for the most part, steam systems. Though they are interested in the potential for medium temperature (120°C max.) hot water distribution, they have no direct experience or specific plans to build such systems.

The Department of National Defence has numerous steam distribution systems on its military bases. There is only one hot water system, which was installed some years ago.

In September 1981, Canada Mortgage and Housing Corporation commissioned a pilot district heating project for the first phase (250 units) of the Le Breton Flats housing project. This project has been designed with low temperature hot water as the heating medium and generally using European D.H. engineering principles, however, it is limited to only heating energy requirements. It is a demonstration project and hence considerable emphasis has been given to an instrumentation and monitoring program.

A preliminary cogeneration study has been commissioned by CMHC for the new town-site of Tumbler Ridge, in North Eastern British Columbia. The study indicates that the most suitable system would be to construct a coal-fired steam boiler, capable of burning garbage, an 8 MW steam turbine and a low temperature hot water distribution system. The main feasibility study is expected to be completed in February 1982 and if the decision is made to implement the cogeneration scheme, design would begin in late 1982.

CMHC commissioned a preliminary study for a cogeneration scheme at the lumber mills of Chapleau, Ontario. The fuel would be wood-waste, the electricity would be distributed by the local utility or Ontario Hydro, the heat would be used to dry lumber and heat the town of Chapleau. The study indicates that the project would be technically and financially attractive. It is planned that a main feasibility study will be conducted prior to authorizing design and construction.

A study was commissioned for a cooling/heating centralized system for major buildings in downtown Toronto. The water at 4°C would be drawn from the bottom of Lake Ontario and distributed to the building cooling systems. During the heating season a large portion of the heat would be produced by centralized heat pumps and utilizing the pipe distribution system. The heating system would extract undesired building heat, raise its temperature and store it for heating as and when required.

Other cogeneration district heating projects are being planned for Edmonton, Regina and Ottawa.

#### 2.2.2 Review of Computer Programs Available in Canada

Four Canadian programs have been, or are being, developed.

They are:

- District Energy System Analysis (DESA) developed by Public Works Canada.
- Hydraulic Distribution Network Design and Analysis Programs (HDNDAP) developed by Consumers Gas.
- Solar Utility Systems Model (SUSYM), developed by DFSMA ATCON LTD. to analyze seasonal storage solar utilities with conventional solar collector fields.

- Storage and Distribution Simulation Model (STORDIST), being developed from basic engineering principles, by DSMA ATCON LTD., in conjunction with the study noted in the CSHPSS program herein. The model accepts variable input and load heat flows and tracks storage and distribution thermal and CoP performance.

### 2.2.3 Codes and Standards in Canada

Distribution system piping in Canada conforms to or exceeds the requirements of the American National Standard Code for pressure piping, ANSI B31.1, except that the most stringent requirements of provincial and municipal regulations are mandatory.

Public Works Canada has internal design guidelines that summarize our experience in supplying heating and cooling services to buildings from a central plant. These guidelines concentrate on soil conditions and the water table recommending various types of distribution systems depending on the underground conditions. The Government of Canada Master Construction Specification (GMS) Section 15051 complements these design guidelines.

### 2.2.4 Application for CSHPSS in Canada

Canada Mortgage and Housing Corporation in conjunction with the National Research Council of Canada are currently conducting a fundamental engineering study to establish the theoretical limits and potential of a solar utility, using sensible heat seasonal storage and low temperature hot water distribution. The study will be completed by March 1982.

It is expected that the application of CSHPSS in Canada will be initially in new, multi-family residential applications because of the opportunity to design for low distribution temperatures, and the economics inherent in such higher density applications.

## 2.3 DENMARK

### 2.3.1 Review of District Heating in Denmark

At the end of the year 1977 about 460 district heating plants were operating in Denmark. This gives the highest percentage of district heating in the world, with about 700 000 out of about 2 000 000 dwellings supplied with district heating.

The production and distribution companies are both public and private in nature, the last group supplying 60% of the district heating demand.

Only hot water or steam systems have been used. The typical system will be a hot water system with a max. supply temperature of 100°C. Most consumers are connected directly to the district heating system without a heat exchanger.

The total district heating production in 1976 was 77 500 TJ with 32% generated in combined heat and power plants, 65% in heat-only plants, and 3% were generated in incineration plants.

During a period of 80 years a 16 000 km distribution system has been established. Until 1965 the typical system in use was steel pipes in concrete canals insulated with the lightweight cellular concrete and mineral wool. After that time a steadily increasing use of preinsulated pipes has taken place, using polyurethane as the insulating material.

In the years to come district heating is expected to play an even greater role, more and more using combined heat and power plants fired with coal.

### 2.3.2 Review of Computer Programs available in Denmark

For economical sizing of district heating pipelines computer programs have been developed.



### 2.3.3 Codes and Standards in Denmark

So far there have been no norms and standards for district heating in Denmark. Such norms are, however, being worked out, and are called DS F 80/211-215.

When constructing buildings there are standards for the heating and ventilation installations.

### 2.3.4 Application for CSHPSS in Denmark

In Denmark solar heating systems will only be used for new buildings. In existing buildings, the design supply temperature is 80-90°C, which is unsuitable for solar heating applications.

## 2.4 ITALY (European Community)

### 2.4.1 Review of District Heating in Italy

District heating is not yet very well developed in Italy. There are a number of small district heating systems which are not connected with electricity plants. They are mainly used in the centres of the cities.

The only town with a significant district heating system is Brescia. This system delivers heat for house heating and domestic hot water to 365 subscribers with a total building volume of 7 200 000 cubic meters. The yearly amount of distributed heat is about 1 000 TJ.

A number of municipalities in the northern part of Italy have been studying district heating. The largest potential district heating system is in the city of Milano, but systems are also planned in new areas around Rome.

A rough estimate indicates that systems producing a total of approximately 200-300 MW/year could be built by the middle of the 1980s. This corresponds to about 60 km of pipeline a year.

2.4.2 Review of Computer Programs available in Italy

No computer programs for district heating have been developed in Italy.

2.4.3 Codes and Standards in Italy

There are no codes and standards which can be considered as imposing special limitations on engineering design of distribution systems, or space and water heating systems.

2.4.4 Application for CSHPSS in Italy

Since solar heating requires very low return temperatures of the heat medium, all solar heating applications must be in new buildings.

2.5 FEDERAL REPUBLIC OF GERMANY

2.5.1 Review of District heating in the Federal Republic of Germany

The district heating supply started in Germany before 1900, but the rate has increased since 1920. In 1977 the heat load was 25 times the heat load in 1950. Since 1970, the rate of growth has been about 8% per year.

The position at the beginning of 1977 was as follows:

112 contractors for district heating supply managed 477 distribution networks with a total length of 5478 km. The total heat load was about 24 105 MW with an input of 44 316 GWh. 90% of the input was used for space heating and hot water supply and 10% for process heating. About 7% of all heating demand in households (that means 1 700 000 households) was secured by district heating. In large towns 13% and in the country 1% of all households were supplied by district heating.

At that time only the following technical systems for district heating had been installed, and were the object of research and development work:

- cogeneration of heat and electric power
- waste heat from nuclear power stations
- total energy systems.

There are no district heating plants using solar energy.

The total increase in connection value is at the present about 900 MW/year.

#### 2.5.2 Review of Computer Programs available in the Federal Republic of Germany

There are computer programs in Germany for sizing and optimization of heat distribution systems, but they have not been published, and are therefore not generally available. Engineering consultants have developed programs to plan actual distribution networks especially for public suppliers.

#### 2.5.3 Codes and Standards in the Federal Republic of Germany

There are four main institutions in Germany which give codes, standards and guidelines for the planning and construction of heat distribution networks:

- |       |  |
|-------|--|
| DIN:  | Deutsche Industrie Norm                  |
| VDI:  | Verband Deutscher Ingenieure             |
| AGFW: | Arbeitsgemeinschaft Fernwärme e.V.       |
| VDE:  | Vereinigung Deutscher Elektrizitätswerke |

Global Treatment

- A GFW: Technical Instructions for the Construction of District Heating Network  
Verlags- und Wirtschaftsgesellschaft  
VDEW, Frankfurt
- A GFW: District Heating Supply of Heating Plants, Planning, Construction, Operation  
Verlags- und Wirtschaftsgesellschaft  
VDEW, Frankfurt/M

House Connection

- DIN 4701: Rules for calculation of the heat requirement of buildings
- DIN 18380: Contract procedure for building work, part C: general technical specifications for building works, systems fo
- VDE: Technical Instructions for House connections to District Heating Systems.

PipingGeneral treatment

- DIN 1998 Placing of services conduits in public areas; directives for planning
- DIN 2401 Pressure containing piping components; details on pressures and temperatures, definitions, nominal pressure rating

- DIN 2402 Nominal sizes; terms, identification numbers
- DIN 2403 Identification code for pipelines according to media.

#### Steel Pipes

- DIN 2413 Steel pipes, calculation of wall thickness subjected to internal pressure
- DIN 2429 Symbols for pipeline systems
- DIN 2440 Steel tubes; medium-weight suitable for screwing
- DIN 2441 Steel tubes, heavy-weight, suitable for screwing
- DIN 2442 Threaded tubes made to quality specifications, nominal pressures 1 to 100
- DIN 2448 Seamless steel tubes, dimensions and weights
- DIN 2449 Seamless steel tubes, St 100
- DIN 2450 Seamless steel tubes, St 35

#### Laying of Pipes

- DIN 18421 Contract procedure for building works, part C: general technical specifications for building works, thermal insulation works on technical installations
- VDI 2055 Thermal insulation for heating and refrigeration

### Insulation

DIN 18421 Contract procedure for building works, part C: general technical specifications for building works, thermal insulation works on technical installations

VDI 2055 Thermal insulation for heating and refrigeration

### Corrosion

VDI 2034 Prevention of damage by means of corrosion in steam heating systems

VDI 2035 Prevention of damage by means of corrosion and scale formation in warm water heating systems

#### 2.5.4 Application for CSH PSS in the Federal Republic of Germany

There are no solar heating plants working in Germany. Even for single family houses there are only a few solar heating plants. With the help of an extensive program in Germany, called ZIP = Zukunftsinvestitionsprogramm, large-scale solar systems for the hot water supplies of public and private buildings have been constructed. There are a lot of hot water systems working with collector areas up to  $300 \text{ m}^2$  and tank volumes of about  $30 \text{ m}^3$ .

Solar systems for the supply of hot water for a whole military area with barracks, kitchen, hospital and gymnasium are planned for the future.

Beside the work in Task VII, there is some system analysis and planning work for introducing solar energy into district heating systems without seasonal storage.

## 2.6 THE NETHERLANDS

### 2.6.1 Review of District Heating in The Netherlands

Before 1975 district heating was only applied in parts of a few towns in the Netherlands (e.g. Rotterdam, The Hague, Utrecht, Breda). The main reason for this lack of interest in district heating was the fast development of the distribution network of cheap natural gas all over the country in the sixties.

Recently, however, the existing distribution systems for district heating have been expanded, and new district heating systems in new towns and rapidly expanding cities have been built.

The government supports this growth for reasons of energy conservation, cogeneration possibilities and flexibility to use different fuels.

The Ministry of Economic Affairs has appointed the NEOM (= Nederlandse Energie Ontwikkelings Maatschappij b.v. meaning The Netherlands Energy Developing Company) to play an important part during this period of growth.

From 1975 up to now approximately 92 000 dwellings are being or have already been connected to new district heating systems, and several more projects are under consideration. According to the official government plans 350 000 dwellings, corresponding to about 3 500 MW, will be connected to district heating by the year 2000.

### 2.6.2 Review of Computer Programs available in The Netherlands

A group of researchers coordinated by Delft University of Technology is working on special computer models to optimize heat distribution networks for district heating systems.

Several consulting engineering companies have developed programs for the optimization of layout and sizing of district heating schemes. Comprimo-Energikonsult b.v. has, for

example, programs for optimization of dimensions and layout of district heating systems, economical planning and pressure drop calculations. Comprimo-Energikonsult also has a computer program for simulating pressure transients in pipeline systems, COMSURGE.

A few manufacturers of piping systems for district heating systems have developed several simple procedures for calculation of pressure drops, layout and dimensioning.

### 2.6.3 Codes and Standards in The Netherlands

Very few codes and standards issued by the Dutch authorities are applicable to district heating piping. The Dutch authorities have established statutory rules and regulations for equipment containing vapours and liquids at relatively high temperature and/or pressure. These rules and regulations are issued in the following publications:

- De Stoomwet 1953 (Steam Act 1953).
- Het Stoombesluit 1953 (The Steam Decree 1953).
- Drukhoudersbesluit (Pressure Vessel Decree).
- Ministeriele Beschikkingen (Ministerial Decrees).
- Voorschriften uitgevaardigd door het Hoofd van de Dienst voor het Stoomwezen (Directions issued by the principal executive in charge of the Steam Act).

The Netherlands Boiler Inspection ("Dienst voor het Stoomwezen") is entrusted with the supervision of the observance of the statutory regulations.

Stoomwezen falls under the jurisdiction of the "Ministerie van Sociale Zaken en Volksgezondheid" (Ministry of Social Affairs).

Stoomwezen is authorized to impose certain requirements about the design and grade of material used in the construction of pressure vessels and their subsequent inspection.



These requirements are, among others, contained in the following documents:

- "Rules for Pressure Vessels". Volume 1 and 2. Bilingual, brief rules, containing a number of standards, working methods and regulations concerning material construction, fabrication, inspection, testing and the use of pressure vessels, and their protective and other properties.
- Grondslagen July 1965, incl. addenda.  
Basic rules for the assessment of the design and material of construction of equipment containing steam, or other vapours and pressure vessels in general.
- A.K.V. - Aanvullende Keurings-Voorschriften  
(Supplementary Inspection and Testing Requirements).
- A.B.G. - Aanvullende Beoordelings-Grondslagen  
(Supplementary Basic Rules for Assessment).
- V.B.R. - Voorlopige Beoordelings-Richtlijnen  
(Tentative Guiding Principles).
- V.K.R. - Voorlopige Keurings-Richtlijnen  
(Tentative Guiding Principles for Inspection and Testing).

By tradition, American standards are used for piping. The most important ones are:

- API - Standard (American Petroleum Institute)
- ANSI - Standard (American National Standardization Institute)

containing codes and standards for different types of piping, e.g. gas piping, oil piping and hot water piping.

Furthermore, the Dutch Standard Commission has issued rules for piping. These are, however, not applicable for district heating.

#### 2.6.4 Application for CSHPSS in The Netherlands

Owing to the high temperatures in existing buildings (often 90/70°C at design conditions) solar heating systems will probably only be applied in new buildings.

### 2.7 SWEDEN

#### 2.7.1 Review of District Heating in Sweden

District heating in Sweden has always been based on hot water. The development of district heating started in Karlstad in 1948, when the local utility delivered hot water for the heating of buildings close to a central source. Three years later, two other systems were started in Malmö and Norrköping. Since then, and especially during the sixties and the seventies, there has been a fast development of district heating. Today, district heating systems are run in 80 towns and cities. About half of all multi-family buildings in Sweden and 55 000 out of 1 500 000 single family houses are now served by district heating. In addition to this, offices, schools, shops and industries corresponding to approximately 500 000 flats are connected to district heating.

The reasons for district heating were from the start the fuel savings and the cogeneration option. Later on, the advantages regarding environmental aspects were noted. The flexibility of distribution of different forms of raw energy by hot water systems has been observed, especially since the first oil crisis.

The most common way today of providing heat to the district heating systems is by burning oil in hot water boilers. The big cities usually have combined this with the cogeneration of electricity in back pressure plants. In some systems, the heat is provided by refuse incineration, thus replacing imported fuel.

Wood residuals and coal are also used. Electricity can be used under certain circumstances when there is a surplus of hydro or nuclear power.

For the future, district heating makes it possible to introduce large-scale renewable energy. One problem when doing this is the relative high temperature level in existing systems because of the needs of existing old buildings. The development, therefore, is towards lower temperatures, especially return temperatures. Different solutions are being tested.

There is agreement in Sweden that district heating should be continually encouraged. A government proposal shows that it is possible to increase the energy delivered by district heating systems from 26 TWh (94 000 TJ) in 1978 to 46 TWh (165 000 TJ) in 1990.

#### 2.7.2 Review of Computer Programs available in Sweden

In Sweden several engineering and computer consultant companies have developed computer programs for use for designing and simulating district heating. A survey is given below of the most relevant ones.

- Industridata  
R 22003 - Flow distribution in district heating networks
  
- Industridata  
R 01025 - Calculation of strength of frameworks
  
- Industridata  
R 02037 HAPS - Pressure transients in piped networks
  
- AF - Energikonsult  
COMSURGE - Pressure transients in piped networks
  
- AF - Energikonsult  
PIPE - Forces and tensions in piped networks

- AF - Energikonsult  
The computer program system ENOK provides a system for energy planning with several application programs for district heating.  
The most important ones are:  
  
FVKALK - Economical planning of district heating  
FVDIS - Optimization of layout and sizing  
FVTRYCK - Calculation of pressure drops  
  
The computer system ENOK is built up around a data base in which data necessary for all kinds of calculations can be stored.
- Studsvik Energiteknik  
FJV 5 - Optimization of layout and sizing of district heating systems
- Studsvik Energiteknik  
COGEN - Calculation of costs hour by hour for district heating systems with cogeneration
- Studsvik Energiteknik  
FVC 5 - Annual performance and cost analysis.

### 2.7.3 Codes and Standards in Sweden

For the design of district heating systems in Sweden, there are large numbers of codes, standards and recommendations issued by different national boards, institutions and associations. A survey of the most important ones is given below:

Issued by the Swedish District Heating Association:

- General provisions for supply of district heating
- Instructions for connection to district heating
- Technical terms of delivery of district heating pipelines
- Technical terms of delivery of axial compensators in district heating pipelines
- Technical terms of delivery of bends in district heating pipelines
- Technical terms of delivery of welded steel pipes in district heating pipelines
- Technical terms of delivery of heat meters for district heating
- Delivery security of district heating
- Guidelines for hot water boiler stations
- Additives to district heating water
- District heating application of the Swedish Piping Code

Issued by the Swedish Pressure Vessel Commission:

- Swedish Piping Code
- Swedish Pressure Vessel Code
- Swedish Hot Water Code
- Swedish Pipe Welding Code

Issued by the National Swedish Committee on Regulations for Steel Structure:

- Regulations for Steel Structure.

2.7.4 Application for CSHPSS in Sweden

Partly owing to the high temperature level in heating systems in existing building (often 80/60<sup>0</sup>C at design conditions) solar heating systems will first be applied in new buildings. If the development of CSHPSS is successful these systems also will be applied in existing areas.

In Sweden, the standard design temperatures for low temperature systems in new building are about 55/45°C for space heating. For tap hot water, the minimum required temperature is 45°C.

## 2.8 SWITZERLAND

### 2.8.1 Review of District Heating in Switzerland

In Switzerland the importance of district heating has always been very small. Existing district heating systems are concentrated mostly around and in the big cities and mainly serving apartment houses, administration buildings, etc. For obvious reasons, district heating has not been developed very much in the very mountainous areas of Switzerland.

Individual houses are not connected, because traditionally the Swiss prefer a certain degree of independence and are reluctant to "share" a system with others.

Since the energy crisis, it has been seen that the dependence on oil as well as the dependence on foreign countries are too large. Unfortunately, the exploration and use of hydro-electric energy is limited (about 14% of all energy consumed is of this type) and the introduction and use of nuclear energy has been delayed because of growing awareness and anxiety about nuclear power and pollution.

The country possesses very poor energy resources (wood, artificial petrol, etc.).

Given these constraints the government elaborated objectives aimed at obtaining a sufficient supply, diversification in energy resources, certainty of supply, optimal use of energy and elimination of energy pollution. The country wants to be less dependent on petrol and is heavily promoting the use of other energy resources (coal, gas, etc.). Rationalization of energy on

the short-term is emphasized as being easy and effective. A general energy concept (GEK) has been elaborated by a Federal Commission. There is a tendency to stress the competence and authority of the Federal government with respect to energy problems and energy policy.

After the oil crisis, attempts were made to develop other heating systems such as solar heating. Space heating systems have been developed which work with lower temperatures (floor heating). The application of lower temperature is interesting in many respects since the systems can use not only solar energy, but also heat of low temperature of various industrial processes that up to now has been considered as waste heat.

Another factor which positively influences the reconsideration of district heating is that the owners of future nuclear power plants may be obliged to generate electricity as well as heat for district heating systems (cogeneration). Also power plants using coal or gas are being discussed.

District heating might even become as easy to use as domestic heating by electricity, which is widely used in Switzerland. Of course, important pressure groups are against district heating such as the companies which sell oil for heating purposes and the many professional oil transporters, who make a living of delivering oil to the customer. However, the trend to reconsider district heating cannot be reversed and district heating is already economic. The economic benefits will increase as oil prices increase. Marketing surveys have shown that the tariffs for district heating are no longer a barrier and have become competitive with conventional heating tariffs.

District heating will be slowly applied to large housing groups and industries. At a later stage, district heating will be used for individual houses in cities.

The design of large district heating distribution systems is compatible with the development of nuclear or thermal power plants using the principles of cogeneration of heat and electricity.

The optimum size of the distribution systems has not been agreed by the many pressure groups. The development of district heating is therefore a political problem as well as an economic problem.

As a conclusion, it can be stated that district heating entered a new stage after a long period of stagnation. Rationalization and diversification of energy resources can easily be obtained. There ought not to be a fundamental incompatibility with existing energy generation and distribution systems. District heating is flexible and clean and in many cases shows significant advantages for the consumer like competitive prices and high reliability of energy supply.

In Switzerland, the total number of larger district heating systems is about 20. Of these about 5 systems have a maximum heat demand exceeding 20 MW. Three of them are greater than 150 MW. The biggest heat generation plant is located in Basle and has a capacity of 490 MW.

About US \$ 50 000 000 are predicted to be invested per year in district heating pipelines during the next 15 years. This corresponds to approximately 90 km a year.

#### 2.8.2 Review of Computer Programs available in Switzerland

- ASKA-PIPE  
Program for strength calculation of pipes.
- PIPDYM II  
Program for calculation of static and dynamic forces and torques in pipe systems.
- PLAST  
Program for dynamic elastoplastic analysis of pipe system.
- PIPE STRESS  
Static and dynamic structural analysis to calculate forces, displacements and stresses for piping systems.



- DIANE  
Program for detailed analysis of elbows and curved pipes.
- MEWAL  
Analysis of economic viability of investment projects.

### 2.8.3 Codes and Standards in Switzerland

In Switzerland there are no legal limitations with respect to application of distribution systems.

For buildings, a series of limitations are valid with respect to the safety of the heating systems. These concern specifically high temperature ranges. For example, steam or superheated water are not permitted directly in buildings for heating purposes without special approval.

### 2.8.4 Application for CSHPSS in Switzerland

Swiss applications of CSHPSS will probably be made in

- 1) Residential single units, new construction
- 2) Residential multi-units, new construction
- 3) Commercial units, new construction
- 4) Institutional units, new construction

For new buildings the typical heating temperature range will be in the low temperature range which means the highest supply temperature will be about 50°C and there will be a temperature difference of about 10°C.

Most existing buildings are equipped with high temperature systems, which means they use maximum temperatures of 70°C - 90°C. This is the main reason why, in Switzerland, there is some economic reluctance to apply solar to space heating systems in existing buildings, because the solar heating temperature range is not high enough to supply heat to the existing buildings efficiently, without replacing in these buildings the high temperature space heating system with a low temperature system (floor heating).

## 2.9 UNITED KINGDOM

### 2.9.1 Review of District Heating in the United Kingdom

The proportion of district heating to other forms of domestic heating within the UK is very small. The main reasons for this are twofold, the first and most important being the ready availability of natural gas from a well established gas grid. Prices of natural gas have, since 1973, been below those of world oil. The other factor affecting district heating in the UK is the wide choice of fuels available and the consequent high degree of freedom of choice for the individual consumer. It is also worth noting that the UK, owing to its geographical location, has a climate less severe than that of many other northern European countries.

Against this background of competition and choice, many DH systems have been successfully completed in recent years, ranging from systems of a few tens of dwellings to over five thousand in one network. The fuels used for these systems have been gas, oil and solid fuel, the first becoming more popular in recent years. Hot water has been used as the heat transfer medium in the great majority of cases.

There is a renewed interest in district heating as a result of the recent emphasis on CHP (combined heat and power), and advances in coal burning technology (e.g. fluidised bed boilers). Mr. David Howell, as Secretary of State for Energy, told the House of Commons, "CHP systems could fit well with the Government's energy policy. They would improve the overall efficiency of producing energy locally, effectively increase energy supplies, and offer further flexibility." The interest of the Government is also indicated by the financial aid available for the update and improvement of CHP/DH systems. An important Energy Paper published recently in the UK identifies CHP/DH as an area of growth for the supply of heat to both industrial and domestic premises.

According to the Marshall report published in April 1979 about "Combined heat and electrical power in the UK" about 50% of the heat demand in UK could be connected to CHP-supplied district heating systems. The Greater London district alone could have 16 000 MW of heat connected to district heating. The 5 biggest metropolitan areas in the UK (Greater London, West Midlands, Greater Manchester, Merseyside and Glasgow) would have a total heat demand of 25 000 MW.

Although this official report strongly recommends a wider introduction of district heating in the UK, prices for fuel, particularly gas, would have to rise considerably for the consumer to benefit from district heating.

#### 2.9.2 Review of Computer Programs available in the United Kingdom

- PISCES  
Program for sizing pipe systems.
- MESH  
Program for pressure drop calculation.
- COLO  
Program for calculation of heating and cooling loads.
- ENPRO  
Program for calculating the annual consumption of buildings with traditional heating and cooling systems.

#### 2.9.3 Codes and Standards in the United Kingdom

There are many Codes of Practice and British Standards which cover pipework and fitting, and also thermal insulation for both normal and underground systems. These publications cover most materials in common use, giving values for maximum working temperatures and pressures and standard sizes. The computer program PISCES, mentioned in section 2.9.2, uses British Standard pipe sizes when selecting suitable diameters.

The following British Standards are applicable to hot water distribution systems:

**BS 1387:**      **Specification for Steel Tubes and Tubulars**  
                    This British Standard applies to welded and seamless, screwed and socketed steel tubes and tubulars, and to plain and steel tubes suitable for screwing.

**BS 3601:**      **Specification for Steel Pipes and tubes for pressure purposes: carbon steel with specified room temperature properties.**

                    This British Standard specified requirements for plain end, welded and seamless carbon steel tubes are suitable for general purposes.

**BS 2871:**      **Specification for Copper and Copper Alloys, Part 1**  
**Copper tubes for water, gas and sanitation.**

                    Included in this are the requirements for half hard copper tubes in straight lengths and annealed copper tubes in coils suitable for burying underground and for connection by means of compression fittings and capillary fittings or by silver brazing or by bronze or autogenous welding.

**BS 864**        **Specification for capillary and compression Part 2**  
**fittings of copper and copper alloy.**

                    This part of this British Standard specified requirements for capillary fittings and compression fittings for use with copper tubes complying with BS 2871, Part 1, Tables X, Y and Z. It applies to the most commonly used types of fittings of nominal sizes ranging from 6 to 54 mm inclusive.

As well as the British Standard specifications mentioned above, there are also numerous Codes of Practice which deal with both internal and external fittings, and the relevant codes would be specified in the contract for a particular job.

#### 2.9.4 Application for CSHPSS in the United Kingdom

Although we do not wish to limit the scope of possible applications, the main areas of interest for the UK are residential single units (new construction), and commercial units (new).

The reason for opting for new constructions is that most of the existing heating systems in both the residential and commercial fields are based on high grade energy and therefore the distribution temperatures would be well above the optimum for a solar heating system. Previous work on solar space heating indicates that the benefits obtained from reducing the distribution temperature are considerable, and since it is very expensive to fit a low grade space heating system to an existing property, a new construction would be a more practical proposition. As an example of this, the normal supply/return temperatures for a domestic system (hot water radiators) would be 80/70°C, but for an interseasonal solar store the useful temperature range should extend down to about 30°C (or less). The additional cost and complexity of heat pumps will be avoided if possible.

Therefore, unless heat pumps are to be included, the potential for retrofitting solar district heating to existing centrally-heated houses is low. Where solar space heating has been installed in individual houses, the trend is towards warm air or underfloor heat distribution systems in order to achieve a balanced system design, matching the low temperature levels to the supply.

The temperature levels associated with the preheating of domestic hot water are higher, and therefore there will have to be a careful investigation into the economic tradeoff between

supplying this load and reducing the temperature of the solar collection. The advantage of certain commercial building loads is that the hot water requirement will be a smaller percentage of the total load than would be the case in residential buildings.

## 2.10 UNITED STATES OF AMERICA

### 2.10.1 Review of District Heating in the United States of America

District heating is not a new technology. The concept was first used in the United States over 100 years ago. The first systems were designed around heat-only boilers that supplied steam for space heating. During the early part of the 20th century, the first small cogeneration district heating plans came into existence. These systems used the exhaust steam from duo-purpose power plants to heat buildings in nearby business districts. As a result, district heating combined with cogeneration was widely accepted. During the late 1940s, this situation changed when the introduction of inexpensive oil and natural gas for space heating reduced the rapid growth of district heating. At about the same time, utilities were introducing large condensing steam-electric power plants remotely located from urban areas. As the smaller, older cogeneration units were retired, sources for the steam district heating system were eliminated and the cost of supplying steam escalated, making district heating even less attractive. Many early projects were not profitable owing to inadequate rates or lack of proper metering devices. For example, as cost increased during the transition from the use of exhaust steam to prime steam, rates were kept low by regulation. As a result, utilities shut down many small district heating systems because they were not profitable.

Recent International District Heating Association (IDHA) statistics for 44 U.S. steam district heating utilities indicate that over the past three years there has been a general decline in the industry with a decrease in steam sales of about 6% from 1976 to 1978. Today, existing district heating systems, including

those serving cities, government institutions, and college campuses, satisfy approximately 1% of the total demand for space and hot water heating in the United States. The development of modern hot water district heating has only taken place on college campuses, new regional shopping centres, and other institutional developments. However, these have been very limited in number and are generally small systems. Two examples of these include a segment of Ohio State University and a portion of Lake LeeAnn Village in Reston, Virginia, which both serve hot water for heating and chilled water for cooling. There are no major hot water district heating systems in the United States. There are a few of the community type systems as mentioned above, however, the design cost data are not transferable to a modern hot water solar district heating system.

In the United States at the present time, there are four investigations on the feasibility of hot water district heating systems: Twin Cities in Minneapolis-St. Paul; Moorhead, Minnesota; Piqua, Ohio; and Bellingham, Washington. These cities range in population from 20 000 to approximately 1 000 000 people. A detailed analysis for the Minneapolis-St. Paul area shows that a district heating is technically feasible, has great value for fuel conservation, and with municipal financing is economically possible. Planning is now underway to initiate a new hot water cogeneration/district heating system in St. Paul.

#### 2.10.2 Review of Computer Programs available in the United States of America

##### - DESA

"DESA" (The District Energy System Analysis) is a computerized design/cost energy accounting model that facilitates analysis of alternative methods of providing heating, cooling and electrical power generation to urban areas.

- The District Heating and Cooling Strategy Model

"The District Heating and Cooling Strategy Model" is a computer program capable of determining the feasibility of hypothetical hot water District Heating and Cooling Systems, using thermal energy from boilers, and the retrofit of existing central station electric generating facilities for cogeneration capacity.

- GEOCITY

"GEOCITY" is a computer simulation model developed to study the economics of district heating using geothermal energy.

- COST

"COST" (The Cost Optimized Selection Technique) is a computer program developed by Mathtech for DOE and ANL to assist in the initial, conceptual design and evaluation of complex energy systems, including cogeneration and cascade systems for residential, commercial, and/or industrial users.

### 2.10.3 Codes and Standards in the United States of America

No codes and standards have been developed for district heating distribution systems at this time.

The in-building codes and standards are specified by the American Society of Heating and Refrigeration and Air Conditioning Engineers (ASHRAE). The code that is presently being enforced is ASHRAE 90-75. The U.S. is also considering Building Energy Performance Standards (BEPS).

The International District Heating Association (IDHA) is in the process of preparing a new handbook, and it will include hot water distribution systems.



#### 2.10.4 Application for CSHPSS in the United States of America

District heating is more attractive for areas of high heat load densities. In the U.S. there appear to be numerous opportunities in existing cities with high heat load densities. Northern cities have urban modernization areas which include new constructions and the remodeling of older structures. A solar district heating utility could integrate into a commercial and multi-unit residential area of an existing city that is involved in urban modernization. The application could be directed at the New England area and/or the upper plains states near the border of Canada. An advantage of the second option is that this region is using expensive import oil and gas.

### 3. BASIC ASSUMPTIONS FOR THE HEAT DISTRIBUTION IN A CENTRAL SOLAR HEATING PLANT WITH SEASONAL STORAGE (CSHPSS)

#### 3.1 General matters

The wide experience of district heating has shown that the only heat carrier we need to consider in a solar plant is hot water. Most CSHPSSs will work with rather low temperatures, which exclude steam as the heat carrier. In some applications, temperatures above the boiling point of water are of interest, but these applications can easily be served by hot water distribution through pressurizing the water.

The participants decided at an early stage that the temperatures of the hot water in the distribution system would be within the range of 10 - 150°C. This does not mean that every application must use this wide range, but the collection of basic data must take the whole range into account. Consequently, different types of heat distribution pipes can be used: for lower temperatures, plastic materials could be used, whereas metal pipes must be used for higher temperatures.

The heat distribution system can be divided into two parts: the transmission of heat from the solar collectors to the storage and the distribution from the storage to each of the consumers. The technical characteristics of these two parts can be significantly different.

The distribution systems include all piping, heat exchangers, controls and auxiliary equipment needed for connecting solar collection with storage and storage with the consumers' heat load. For example, heat exchangers in a customer's property should be included; a heat exchanger which is part of the collection sub-system should not.

### 3.2 Transmission from solar collectors to storage

In many climates the maximum solar heat input to a solar collector is around  $1000 \text{ W/m}^2$  and the yearly amount of energy  $1000 \text{ kWh/m}^2$  or slightly higher. This means that the collection circuit must be dimensioned for a sharp peak with a short utilization period. In order to minimize the costs for the system, this favours the location of the storage close to the solar collectors.

The solar collector circuit and the transmission line to the storage must be able to cope with the highest temperature that can be achieved in the solar collectors. Thus the transmission must be carefully designed.

Consequently, in a CSHPSS, we expect the peak capacity and the highest temperatures when transmitting the heat from the solar collectors to the storage. This might mean that better quality piping and auxiliary equipment must be used in this part of the heat transportation system than that used from storage to consumer.

### 3.3 Distribution from storage to consumers

The total peak of the heat load (space heating + tap hot water) depends very much on the number of dwellings served by the system. With few dwellings the peak of heating hot water will dominate over the peak of space heating. In big district heating systems in northern Europe, the total peak will in many cases consist of 90% space heating and 10% tap hot water heating. This effect occurs as different dwellings do not use tap hot water at the very same time, whereas the space heating demands coincide.

Within our Task most CSHPSS applications seem to consist of rather few dwellings. The tap hot water peak will then probably in most cases be dominant when designing the heat distribution system from storage to consumers. A way of reducing the maximum peak in such cases is to let the tap hot water heater momentarily "steal" heat from the space heating circuit. The maximum peak in the system will then equal the peak of heating tap hot water. This can be done as the space heating circuit has a built in thermal capacity that can be used to bridge short-term interruptions in the supply. Another possibility of reducing the dimensions of the distribution system is to install short-term distributed storages for tap hot water close to each consumer. The optimization procedure can ascertain whether either of these solutions is financially justifiable for a given type of a CSHPSS.

For bigger systems, where the peak load will be determined by the need for space heating, the dimensioning may be somewhat easier. In such cases the peak of the total heat load is no longer as sharp. It is then possible to operate the distribution network from the centralized store to each consumer with a longer utilization period, which is more economic.

The internal heating system for new buildings can be designed for different temperature levels. In applications with lower distribution temperatures more simple piping can be used. This can mean a considerable saving in the costs for installing the distribution system. Therefore, it is important that this calculation is part of the overall optimization of a solar utility.

#### 3.4

##### Consumer installations

All participants have agreed that only new developments served by a CSHPSS should be considered in this Task. When doing the calculations, we thus have full freedom in choosing the system for the internal heat distribution within every connected building. In some ways, it makes our calculations easier as we do not have to consider the retrofitting of older installations into

modern ones capable of receiving solar heat. On the other hand, it can make the overall optimization procedure more complicated as there are more unknown parameters.

The internal heat distribution system often uses water as the heat carrier. However, the use of hot air as heat carrier is of great interest for applications using low temperatures. In this Task, we have a free choice for the heat carrier within the buildings.

When working with new developments, it is also possible to aim towards a total optimization between the provision of solar heat through the CSHPSS and the technical standard of the performance of the connected buildings. For instance, the degree of insulation has to be considered in relation to solar collector area and storage volume. It has, however, not been in the scope of this Subtask to collect data on the performance of the buildings.

For the study of the solar utility itself, it might be of interest to choose a typical building and apply the CSHPSS to it. In this case, the installation in the buildings will naturally be governed by the performance according to national standards.

### 3.5 The designing procedure

When designing the heat distribution system in a CSHPSS, the basic principles are the same as for conventional district heating. Thus it could be of interest to give a rather detailed description of the normal design procedure. Attachment A "Dimensioning of district heating piping systems" describes this procedure thoroughly. It is based on conventional district heating as practised in Sweden. In the following we assume that the basic principles are generally known.

The first step of calculating the supply and return temperatures in a CSHPSS is to determine the limits set by the equipment that will be used. The supply temperature is more or less given by the type of solar collector and the return temperature by the type of installation used in the connected buildings. If the distribution is divided into two parts by the heat storage, the storage sets the return temperature to the solar collector circuit and the supply temperature of the consumer circuit. Thus it is necessary to do this first part of the calculation by hand.

The second step could be a more detailed, marginal analysis of desired temperatures with the help of MINSUN<sup>x)</sup>. It is then possible to finally decide the supply and return temperature, thus giving the temperature difference at which the distribution system has to work. Then we can calculate the water flow in the system and optimise piping versus pumping.

The third step comprises the optimisation of insulation thickness of the piping. In a solar utility it has to be weighed against, among others, solar collector surface and storage volume.

In a conventional district heating system, the supply temperature is generally raised when the peak demand occurs. This makes it possible to operate the distribution system with a relatively constant flow, which reduces the distribution costs. In a CSHPSS it can be difficult to achieve this, as there probably exists an upper temperature limit built into the system. To avoid sharp flow peaks, demanding extra area of piping, it may in certain cases be of interest to install small distributed storage in the substations at the consumers.

- x) MINSUN is a computer program intended for optimization of the configuration of a CSHPSS. Documentation of the MINSUN program will be provided in future reports of Task VII.

When there is a demand for tap hot water, the momentary heat demand can be very high. A way of stopping this peak fully affecting the distribution system, is to guide all capacity to the tap hot water heater, thus "stealing" from the domestic heat demand. This can be permitted, as there is a thermal delay built into the system due to thermal inertia. Such a function is normally included in the consumer installation.

Water velocities cannot be too high in hot water distribution systems. The higher the velocity, the bigger the pumping power. The relation between velocity and pumping power is sharply progressive, thus setting a highest practical water velocity. According to conventional district heating practice, water velocities normally do not exceed 3 m/s. Furthermore, this figure is valid only for bigger pipes (transmission mains for parts of cities). For smaller pipes water velocities in the order of 1 m/s can be optimal. More information about suitable water velocities can be found in attachment A.

In a district heating system there is always a simultaneity factor. This is due to the fact that tap hot water is not heated at the same time in every dwelling. The size of the simultaneity factor has to be derived from experience. It depends on how many dwellings are connected to the system and is most noticeable close to the central heating generation plant. In a solar utility the same phenomenon occurs, though it may not be so noticeable as the size of the system will be less.

#### 4. COLLECTION OF DATA

In this chapter, a survey of data given by the participating countries is presented.

The aim of the collection of data is as follows:

- To establish curves for deriving general formulas of cost equations
- To provide cost data for countries without their own experience
- To make comparisons possible
- To collect cost data suitable for every specific site design.

Given costs should be used as general indications. They have been derived as mean values of costs given by participating countries. In specific cases and for detailed calculations, costs must be determined for every special situation and specific site.

##### 4.1 General conditions

All costs have been expressed in US \$ according to its value and the cost level in July 1980. Below are the conversion factors used when transferring the costs into US \$. (Different exchange rates do not affect the general formulas for the cost equations derived below):

1 US \$	=	12.40 Schilling	Austria
		1.15 Can \$	Canada
		5.41 DKR	Denmark
		840 Lire	Italy
		1.75 DM	West Germany
		1.91 HFL	Netherlands
		4.13 SEK	Sweden
		1.61 SFR	Switzerland
		0.42 £	UK



## 4.2 Piping

The costs given by the formulas below are based on information given by the participating countries for pipelines laid under normal conditions, and are intended to describe the total installation costs, i.e. including pavement restoration, costs for valves and expansion loops, costs for construction of valve chambers etc.

For each type of pipeline short summaries of the cost information prepared by the participating countries are given as attachments. Here is noted if the basis for the cost information given by any country is not in accordance with what is asked for.

### 4.2.1 Steel Pipes

For steel pipelines, the cost relations can be approximately expressed as follows:

Inner diameter, $d_i$ mm	Costs US \$/m
20 - 400	$1.98 \times 10^{-3} \times d_i^2 + 1.46 \times d_i + 135$

No significant cost difference can be seen between mineral wool and polyurethane insulated pipelines, as well as between pipelines with different insulation thickness.

In attachment B1, diagrams showing pipeline investment costs given by the participating countries, as well as the above-mentioned cost relations, are presented.

In attachment B2, further basic information about steel pipelines is presented.

#### 4.2.2 Copper pipes

For copper pipelines, the cost relations can be approximately expressed as follows:

Inner diameter, $d_i$ mm	Costs US \$/m
20 - 100	$1.92 \times 10^{-2} \times d_i^2 + 1.33 \times d_i + 65.8$

No significant cost difference can be seen between mineral wool and polyurethane insulated pipelines, as well as between pipelines with different insulation thickness.

In attachment C1, a diagram showing pipeline investment costs given by the participating countries, as well as the above-mentioned cost relations, is presented.

In attachment C2, further basic information about copper pipelines is presented.

#### 4.2.3 Other pipe materials

About pipe made of other materials than steel and copper, information has been received from Sweden about pipes made of cross-linked polythene and from USA about fiberglass reinforced plastic pipes. The cost relations can approximately be expressed as follows:

Pipe material	Inner diameter $d_i$ mm	Costs US \$/m
Cross-linked polythene	25 - 90	$0.69 \times d_i + 52$
Fiberglass, enforced plastic	60 - 300	$5.51 \times 10^{-3} \times d_i^2 + 0.184 \times d_i + 159$

In attachment D1, diagrams showing pipeline investment costs given by the participating countries, as well as the above-mentioned cost relations, are presented.

In attachment D2, further basic information about pipes made of other materials than steel and copper is presented.

#### 4.2.4 Multi-pipe culvert

Probable relations between the double pipe culvert and those containing 4 or 6 pipes are given by the UK participant and are as follows:

$$\begin{aligned} C_4 &= 0.95 \times 2 \times C_2 = 1.90 \times C_2 \\ C_6 &= 0.925 \times 3 \times C_2 = 2.78 \times C_2 \end{aligned}$$

where  $C_x$  is the cost for a culvert containing x pipes.

In attachment E, the above-mentioned cost relations, together with their application to the UK cost information, are shown.

#### 4.2.5 Temperature limits

When using heat carrier medium pipe made of steel or copper, the choice of insulation material is normally the limiting factor regarding the maximum allowable temperature.

For pipelines with polyurethane insulation, it is not recommendable to allow temperatures higher than about 120°C. When reaching this temperature, a chemically destructive process is started in the polyurethane, especially when moisture is present.

For pipelines insulated with mineral wool, Swedish manufacturers of pipe insulation are recommending the normal type of mineral wool as insulation for district heating pipelines for temperatures up to 200-250°C. This covers completely the normal use of district heating.

For district heating normally steel medium pipes are used for dimensions larger than DN 50. For smaller dimensions, it is also common to use copper pipes, due to the fact that the expansion can be absorbed in the mineral wool insulation. This is an advantage in laying of pipelines in a densely built-up area.

When using pipelines with heat carrier pipes made of plastic or any similar materials, it is normally the pipe material that limits the maximum temperature. According to Swedish manufacturers of cross-linked polythene pipes, these can withstand a temperature of 90°C. It is, however, not recommendable to let them operate continuously at temperatures higher than about 60°C. Another problem with pipes made of plastic is the oxygen diffusion, which causes a continuous absorption of oxygen in the district heating water. Due to this fact, all equipment in the system must be of oxygen resistant materials.

#### 4.3 Heat exchangers

The cost relations of heat exchanger can be approximately expressed according to the formulas below:

##### Domestic heating

Capacity, Q kW	Costs US \$
10 - 20	3000
20 - 60	$275 \times Q - 2500$
60 - 200	$-0.268 \times Q^2 + 148 \times Q + 6070$

##### Space heating or storage

Capacity, Q kW	Costs US \$
20 - 250	$-0.08 \times Q^2 + 72 \times Q + 3000$

The main part of the data for the heat exchangers has been related to a logarithmic average temperature difference of 20 - 25°C.

In attachment F1 and F2, diagrams showing investment costs for heat exchangers given by the participating countries, as well as the above-mentioned cost relations, are presented.

#### 4.4 Pumps

The cost relations of pumps can be approximately expressed according to the formulas below:

Power, P kW	Costs US \$
1 - 6	$-74.2 \times P^2 + 993 \times P + 400$
6 - 650	$165 \times P + 2700$

Based on the information received, no significant cost difference between pumps with various speed control equipment can be seen.

In attachment G1, diagrams showing investment costs for pumps given by the participating countries, as well as the above-mentioned cost relations, are presented.

In attachment G2, further basic information about pumps is presented.

#### 4.5 Heat meters

The cost relations of heat meters can be approximately expressed according to the formula below:

Maximum heat flow, Q kW	Costs US \$
10 - 300	$-7.76 \times 10^{-5} \times Q^2 + 0.483 \times Q + 550$

It is not quite clear to which temperature difference of the water the range of heat flow corresponds. The main part, however, is related to 40 - 50°C.

The annual maintenance costs for heat meters will probably be about 10% of the investment costs.

In attachment H1, a diagram showing investment cost for heat meters given by the participating countries, as well as the above-mentioned cost relations, is presented.

In attachment H2, further basic information about heat meters is presented.

#### 4.6 Heat losses

In section 4.2 about pipelines, the heat losses for the main part of the different types of pipelines are given. The heat losses are, however, dependent on factors such as depth of pipe laying, soil conditions etc., which are not known. Therefore, a general formula for how to calculate the pipeline heat losses is given below.

#### 4.6.1 Momentary heat losses

The heat resistance in pipe insulation, pipeline cover, soil and heat transfer between the soil and the ambient air, can be expressed as follows. The heat resistance in the pipe itself and between the water and the pipe is neglected as it is much less than any of the others mentioned.

$$R_i = \frac{1}{2 \pi \lambda_i} \times \ln \frac{D_o}{D_c} \quad \left(\frac{mK}{W}\right) \quad (a)$$

$$R_c = \frac{1}{2 \pi \lambda_c} \times \ln \frac{D_c}{D_o} \quad \left(\frac{mK}{W}\right) \quad (b)$$

$$R_{sa} = \frac{1}{2\pi \lambda_s} \times \ln \left[ \frac{(2(h+\Delta h))}{D_c} \left(1 + \sqrt{1 - \left(\frac{D_c}{2(h+\Delta h)}\right)^2}\right) \right] \quad \left(\frac{mK}{W}\right) \quad (c)$$

where  $\Delta h$  is an additional layer of soil, to approximately describe the heat resistance between the ground surface and ambient air.

$\Delta h$  can be expressed by the following formulas:

$$\Delta h = \frac{\lambda_s}{\alpha_a} \quad (m) \quad (d)$$

where

$$\alpha_a = 5.7 + 3.8 \times w \quad \left(\frac{W}{m^2K}\right) \quad (e)$$

The empirical formula (e) is valid when the wind speed is within a normal range for this application.

The total heat resistance between the hot water and the ambient air can be expressed as follows:

$$R_{tot} = R_i + R_c + R_{sa} \quad \left(\frac{mK}{W}\right) \quad (f)$$

The momentary heat losses can be calculated as below.

$$q_1 = \frac{T_w - T_a}{R_{tot}} \quad \left(\frac{W}{m}\right) \quad (g)$$

This formula is valid for a single pipe. To compensate for the fact that two pipes are laid together, the following correction factor can be used:

$$f = \frac{1}{2} + \frac{1}{\pi} \times \arctan \frac{a \lambda_s}{h \lambda_p} \quad (1) \quad (h)$$

where  $\lambda_p$  is the average heat conductivity for pipe insulation and its cover, and can be expressed as follows.

$$\lambda_p = \frac{\ln \frac{D_c}{D_i}}{\frac{1}{\lambda_i} \times \ln \frac{D_o}{D_i} + \frac{1}{\lambda_c} \times \ln \frac{D_c}{D_o}} \quad \left(\frac{mK}{W}\right) \quad (i)$$

Then the momentary heat losses from two close equal pipes can be calculated according to the following formula.

$$q_2 = 2 \times q_1 \times f \quad \left(\frac{W}{m}\right) \quad (j)$$

which is equal to

$$q_2 = 2 \times \frac{T_w - T_a}{R_{tot}} \times f \quad \left(\frac{W}{m}\right) \quad (k)$$



When the temperatures in the water in the pipes differ, the momentary heat losses can be expressed as:

$$q_2 = 2 \times \frac{\frac{T_S + T_R}{2} - T_a}{R_{tot}} \times f \quad \left(\frac{W}{m}\right) \quad (1)$$

This theory is valid for two equal pipelines laid separately, i.e. with soil all around each one of the pipes. Furthermore, the ratio  $a/h$  must be less than 1.5.

Explanation of parameters

$\lambda_i$	heat conductivity in the insulation material	W/mK
$\lambda_c$	heat conductivity in the insulation cover material	W/mK
$\lambda_s$	heat conductivity in the soil	W/mK
$D_i$	inner diameter of the insulation	m
$D_o$	outer diameter of the insulation, inner diameter of the insulation cover	m
$D_c$	outer diameter of the insulation cover	m
$h$	depth of pipe laying	m
$w$	wind speed	m/s
$T_w$	water temperature, general	K (°C)
$T_S$	water temperature in the supply line	K (°C)
$T_R$	water temperature in the return line	K (°C)

On the next page, a sketch giving further explanations to the parameters is shown.

EXPLANATION OF PARAMETERS FOR CALCULATION OF HEAT LOSSES

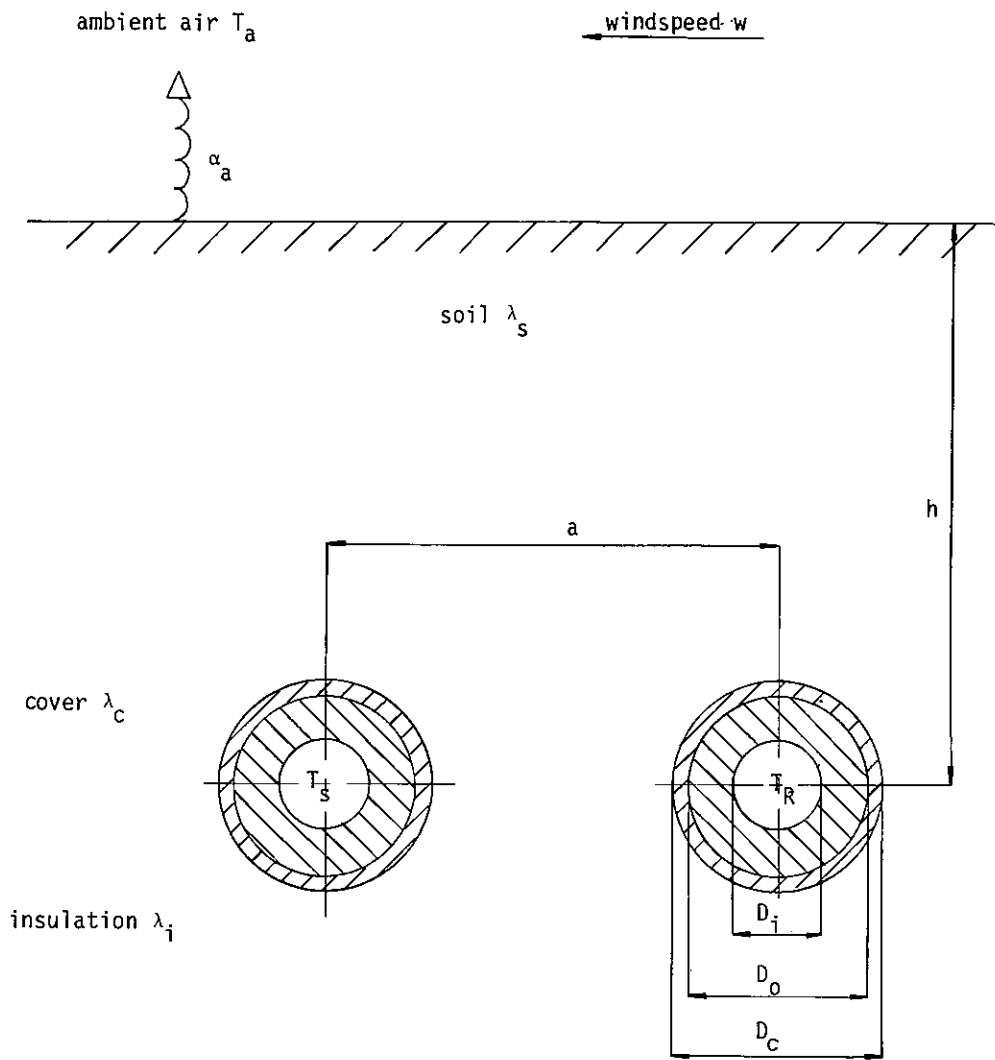

Heat conductivity

Below are given typical values of thermal conductivity in different kinds of soil and insulation materials.

## Soil

Clay, dry	0.20 W/mK
Clay, 20% water content	0.70 W/mK
Clay, 50% water content	1.00 W/mK
Sand, 3-5% water content	2.2 W/mK
Morain clay	2.2 W/mK

## Insulation material

Polyurethane	0.025-0.040 W/mK
Mineral wool	0.040-0.070 W/mK

#### 4.6.2 Annual losses of thermal energy

Based on the above mentioned formulas for how to calculate momentary heat losses, the annual loss of thermal energy can be approximately estimated as follows.

$$Q = 2 \times \frac{\frac{\bar{T}_S + \bar{T}_R}{2} - \bar{T}_a}{R_{\text{tot}}} \times f \times 8760 \quad \left(\frac{\text{Wh}}{\text{ma}}\right) \quad (\text{m})$$

where  $\bar{T}_S$ ,  $\bar{T}_R$  and  $\bar{T}_a$  are the annual average of supply, return and ambient air temperatures respectively.

Alternatively

$$\frac{\bar{T}_S + \bar{T}_R}{2} - \bar{T}_a \quad (\text{K}) \quad (\text{n})$$

can be interpreted as the annual average difference between the water temperatures and the ambient air temperature.

#### 4.6.3 Cost for pipeline insulation

Based upon information from Swedish manufacturers of district heating pipelines, the marginal extra costs for thicker insulation on PU-insulated pipelines are in the size of 1200 \$/m<sup>3</sup>.

The corresponding figure for mineral wool is also based on information given by Swedish manufacturers of pipeline insulation in the size of 100-300 \$/m<sup>3</sup>.

ATTACHMENTS

- A Dimensioning of district heating piping systems
  
- B1 Survey of specific pipeline costs,  
Steel pipes
- B2 Steel pipelines,  
Further basic information
- C1 Survey of specific pipeline costs,  
Copper pipes
- C2 Copper pipelines,  
Further basic information
- D1 Survey of specific pipeline costs,  
Pipes made of other materials
- D2 Pipes made of other materials,  
Further basic information
- E Survey of specific pipeline costs,  
Multi-pipe culvert
  
- F1 Survey of costs for heat exchangers,  
For domestic heating and tap hot water
- F2 Survey of costs for heat exchangers,  
For heating and storage
  
- G1 Survey of costs for pumps
- G2 Pumps, Further basic information
  
- H1 Survey of costs for heat meters
- H2 Heat meters, Further basic information

DIMENSIONING OF DISTRICT HEATING PIPING SYSTEMS

The following description is based on conventional district heating practice in Sweden. However, the basic design rules are the same for any kind of hot water distribution system, and so would be equally applicable to solar heating distribution systems by selection of the appropriate design data.

---

This material is intended to serve as an aid in performing the hydraulic flow design and dimensioning of a district heating piping system. It deals only with the mathematical relationships necessary for this particular application, without considering the basic theory. Any reader wishing to acquire a wider theoretical knowledge base is referred to the specialised literature on hydraulics. However, in order to provide a certain basic understanding of how hydraulic flow calculations for district heating systems should be performed, a certain amount of flow theory will be introduced where necessary.

Design outdoor temperature

A basic element in determining the necessary heat supply capacity of a district heating system is the climatic conditions applicable to the town in question. The maximum load is the determining factor in dimensioning the various items of plant. It is obviously not economically justifiable to dimension equipment to be capable of dealing with an outdoor temperature which may never occur, and so it is necessary to choose a design temperature which is sufficiently low to cover most eventualities, while the likelihood of even lower temperatures is so small that the effects of insufficient heat which would then arise can be accepted by virtue of their infrequency. This problem has been investigated in more detail by the Swedish District Heating Association, which in its report 'Security of Supply for District Heating'\*, recommends district heating operators to choose design outdoor temperatures on the following basis.

---

\* Available only in Swedish.



## ATTACHMENT A

The design power requirement should be determined with respect to a 24-hour average temperature which is so low that the likelihood of such conditions occurring over a 5-day period will be encountered only once in 30 years, as shown in meteorological statistics.

In order to be able to determine the nominal load (the load expected during design outdoor temperature conditions), it is essential to measure the outdoor temperature. Such measurement should be carried out at only one point in the system. This measurement point should be sited where it is representative of temperature conditions in the distribution area. Temperature measurement can often be arranged at some suitable point close to the district heating control room.

#### Temperature and time dependence of the district heating load

The load on a district heating system is largely temperature-dependent, although some of the heat requirement is not temperature-dependent: e.g. the heat needed for domestic hot water production. Somewhat simplified, it is possible to regard the heat load as being made up of a smaller fixed portion and a larger portion which varies throughout the year. Figure 1 is an example of how the overall district heating load depends on temperature. In this example, it can be seen that the fixed portion of the load amounts to somewhat less than 10% of the maximum load. This is the overall system load: at individual level, the fixed portion can naturally vary from subscriber to subscriber on the system.

For any given temperature, the system load also varies on daily and weekly basis. The upper diagram in Figure 2 shows how the heat load can vary on an hourly basis throughout the day. In order to be able to determine the design power requirement, it is therefore also essential to decide which of these values, all reached during a period of the same outdoor temperature, is to be chosen. More on this further on. It is first necessary to see how this load diagram can be converted to a duration diagram, a particularly useful aid to dimensioning a district heating system.

## ATTACHMENT A

The lower diagram in Figure 2 shows the duration diagram for the same period as that covered by the load curve in the upper diagram. The linking arrows show how the duration diagram has been constructed: it consists of the hourly values from the load diagram, sorted into decreasing order of load magnitude. The duration diagram indicates, for example, the number of hours during the day during which the load has exceeded a given value. This particular diagram has been drawn for a 24-hour period, but a similar curve can naturally be drawn for a whole year. Figure 3 is a duration diagram for the heat load as metered at the production point. It is a generalised diagram, with the load expressed in relative quantities. It can be seen, for example, that the load amounts to 50% or more of the maximum load for only about 2000 hours per year, or somewhat less than three months in total. The very short duration of high loads can be seen clearly. Put another way, this means that it is only seldom that conditions approach the design temperature conditions. The area under the curve is the integral with respect to time of heating power, and thus represents the total amount of energy produced during the year. If we draw a horizontal line through the value of half maximum load, we find that a good 90% of the whole year's energy production lies below the line. We shall deal with further application of the duration diagram later in this paper.

The design power requirement in a district heating system

The preceding paragraphs have described how a certain 24-hour mean temperature is to be regarded as the design temperature for a district heating system. The load value which the Swedish District Heating Association recommends should represent the design power requirement is the maximum hourly power during the day concerned. The Association also recommends that, as a basic definition, the relationship between the load and the outdoor temperature shall be regarded as being linear, as shown in Figure 1. This definition makes it possible to determine the power requirement at the outdoor design temperature through extrapolation from a mean curve based on readings made at higher temperatures. It is therefore not essential to observe the load at the design temperature in order to be able to determine it.

## ATTACHMENT A

The load which is 'seen' by the production plant is modified by the effects of diversity: a result of the fact that the individual subscriber loads do not peak simultaneously. This means that it is not necessary to dimension the production plant to be capable of providing a power equivalent to the arithmetical sum of the individual subscribers' maximum power requirements, but for some lower diversity-derived figure. This power is often regarded as amounting to 70-80% of the mathematical total of the subscribers' maximum power requirements. Diversity effects reduce the loadings on main distribution piping and even in a large part of the smaller distribution mains, and advantage can naturally be taken of this when dimensioning the pipes. However, it is necessary to dimension the service connections for the individual subscribers' maximum power requirements, and so in this case it is the subscriber power rating which is decisive. It is difficult to define the subscriber power rating in a physically unambiguous manner, but this should not cause any great problem in the majority of cases as there is considerable difference in capacity between different pipe sizes. In other words, the same size of connection is often used for subscriber power ratings over quite a wide range.

Hot water temperatures

It has become standard Swedish practice to design district heating systems for a maximum supply temperature of 120 °C.

The diagrams in the previous figures show that heat load is very temperature-dependent. As the outdoor temperature falls, the supply temperature is gradually increased up to the maximum of 120 °C, avoiding the necessity of increasing the flow rate. 120 °C is reached at the design outdoor temperature. If the outdoor temperature continues to fall, the supply main temperature is not raised any further, but the water flow rate is increased instead (provided that the production plant can supply the extra output).

Conversely, the water temperature is reduced as the outdoor temperature rises. Where heat is supplied to older buildings with conventional heating

## ATTACHMENT A

systems, the temperature is not normally reduced below about 80 °C, in order to be sure of providing sufficient heat for space heating requirements and domestic hot water production. However, if the load consists of new buildings, designed for lower temperature heating systems, it is permissible to reduce the supply main temperature to a lower value than this.

It is a general aim to attempt to maintain the temperature of a district heating system as low as possible. There are several reasons for this. Lower temperatures reduce heat losses and enable more electrical power to be produced from combined power and heat plants. Solar heating, heat pumps and waste heat sources are all at their best when working into systems with as low operating temperatures as possible. There are also development trends towards new and cheaper materials which could be used in distribution mains if the temperature level could be reduced. This would improve the competitiveness of district heating with other forms of heating. There is therefore considerable development work in progress on low-temperature systems.

The return main temperature of a district heating system is determined by how much heat the consumers can abstract from the hot water. At design conditions, the return main temperature is not generally likely to be at a higher temperature than 70 °C. There is thus a 50 °C available temperature drop. If the return main temperature could be reduced by, say, a further 10 °C, it would increase the temperature difference by 20%. This would result in a corresponding reduction in the system water flow (for a given supply main temperature), which affects pipe sizing. It is therefore important to achieve as low a return main temperature as possible.

In principle, it ought to be possible to connect modern low-temperature heating systems to the return main from an older area. By using this return water in the low-temperature system, the final return temperature can be still further reduced, rendering unnecessary any increased heat distribution capacity for the new load. However, a necessary prerequisite for such an arrangement is that there is an adequate flow of water in the district heating system at the point where the connection is to be made, and that the heating systems in the new area are designed to work at considerable

## ATTACHMENT A

lower temperatures than conventional heating systems. This can be arranged by such means as increased radiator surface areas or by using heated air as the heat distribution medium.

The upper curve in Figure 4 shows a supply main temperature characteristic as a function of outdoor temperature that is often used in district heating systems, while the lower curve is an example of return temperature characteristics.

#### Hot water flows

The water flow in the pipes of a district heating system is directly proportional to the heat load on that pipe and inversely proportional to the temperature difference between the supply and return mains. Flow volume is also partly affected by the density of the water, i.e. it is to some extent temperature-dependent. The actual relationship is given by the equation:

$$\dot{Q} = \dot{m} \cdot c_p \cdot \Delta t = \rho \cdot \dot{V} \cdot c_p \cdot \Delta t$$

where  $\dot{Q}$  = heat power in W.

$\dot{m}$  = water flow in kg/s

$\dot{V}$  = water flow in m<sup>3</sup>/s

$\rho$  = water density in kg/m<sup>3</sup>

$c_p$  = thermal capacity of the water in J/kg, K

$\Delta t$  = temperature difference in K (°C).

Figure 5 is an as-measured example of the relationship between water flow and outdoor temperature. Measurement has been made in the main supply line close to the production plant.

## ATTACHMENT A

In this example, the water flow is greatest at the design temperature. However, for all outdoor temperatures below freezing point the flows are near the maximum flow. This indicates that the distribution system is being utilised in a rational manner, which is naturally the ideal. As described above, the district heating operator can affect the flow by controlling the supply temperature. For this reason, corresponding flow diagrams for other district heating systems would not necessarily have exactly the same shape.

How heat requirements can be supplied from different production sources

In a large district heating system, heat is produced and supplied from a number of sources for base load production. As these plants have a long annual operating time, they can justify investment in greater efficiency, sophistication or flexibility. Combined power and heating plants are typical examples of base load plants. It can be seen from the duration diagram in Figure 6 how the bottom portion of the energy supplied, below the curve, comes from plant of this type. It can be seen that this plant will run at full load for much of the year, thus producing a significant proportion of the entire district heating system annual energy requirement. Heat sources having the shortest annual operating times, i.e. those supplying the energy requirements at the top of the duration curve, must be cheap to build, although high running costs can be tolerated.

This method of ordering production can also affect the design of the distribution system. This becomes apparent primarily when all production units are installed at one and the same point. There may, for example, be aspects of system security and reliability which favour splitting production between two physically widely separated sites in the system. If we assume that the base load heat source is installed alone at one end of the distribution system, it can be interesting to consider how the water flow in the supply main from the plant varies throughout the year. This is shown in Figure 7.

## ATTACHMENT A

In the upper diagram in the figure, the energy supplied by the base load source has been drawn on the duration diagram. The second diagram shows the return main temperature and the resulting necessary supply main temperature, and the bottom diagram shows how the flow in the outgoing supply main will vary. It can be seen that the flow is not at its maximum at the design temperature, but instead is greatest at the load conditions when the base load plant alone can supply the whole system load when operating at its full output power. In other words, as soon as it is necessary to start up other production capacity, the flow from the base load source constitutes only a part of the total flow in the system. A way of avoiding flow peaks in the outgoing supply main would be to raise the temperature of the supply from the base load source above the normal temperature characteristic. This can be seen in the second diagram, where the dotted line shows what happens. The whole is a matter of optimisation, balancing the savings resulting from reduced distribution main dimensions against the energy costs of increasing the supply main temperature.

#### Hydraulic pressure drop in the system

When water flows in a pipe, there is a pressure drop. This is due partly to friction against the pipe walls (frictional resistance) and partly to the equivalent frictional resistance of the fittings and junctions. The pressure drop is largely dependent on the pipe diameter and the flow velocity, as well as on the length of the pipe and on water density. Pressure drop is given by the following equation:

$$\Delta p = \lambda \cdot \frac{l}{d} \cdot \rho \cdot \frac{w^2}{2} \quad \text{Pa} \quad (1)$$

where  $\lambda$  = the friction factor (constant of proportionality)  
 $l$  = length of the pipe in m  
 $d$  = diameter of the pipe in m  
 $\rho$  = water density in kg/m<sup>3</sup>  
 $w$  = water velocity in m/s.

## ATTACHMENT A

The pressure drop as a result of equivalent resistance of fittings etc. is given by the following equation:

$$\Delta p = \xi \cdot \rho \cdot \frac{w^2}{2} \quad \text{Pa} \quad (2)$$

where  $\xi$  = equivalent resistance factor (constant of proportionality).

Both the friction factor and the coefficient of equivalent resistance are empirically determined quantities. The friction factor depends on the internal unevenness (roughness) of the pipe, flow velocity, pipe diameter and fluid viscosity, and is defined by the following relationship for turbulent flow (which is always the case in district heating system) in internally smooth pipes:

$$\lambda = 0.316 \left( \frac{w \cdot d}{\nu} \right)^{-1/4} \quad (3)$$

where  $\frac{w \cdot d}{\nu}$  is Reynold's Number (Re), which is a dimensionless quantity characterising the flow, and where  $\nu$  = the kinematic viscosity in  $\text{m}^2/\text{s}$ .

Figure 8 shows values of the friction factor as a function of Reynold's Number.

The numerical values for equivalent resistances depend on various physical factors. Figure 9 shows examples of typical resistance values which are suitable for use in pressure drop calculations on district heating systems.

In order to overcome the pressure drops associated with water flow, it is necessary to apply a driving force which is supplied by the hot water circulation pumps. This driving force must also be sufficiently large to drive the hot water through the consumers' equipment. The decisive factor in determining the necessary pump head is the need to ensure that there is sufficient pressure head available for a satisfactory supply to the most distant consumers (or, more exactly, consumers with the greatest pressure



## ATTACHMENT A

drop in the mains between them and the production point). A pressure difference of about 100 kPa is usually needed in order to ensure sufficient flow through the consumer equipment.

As described earlier, the flow in a district heating system varies throughout the year. This means that the required pressure head also varies. Relatively high pressure heads are needed for the high flows during the winter, and this is normally arranged by increasing the speed of the main circulation pumps in the production plant. However, in large systems it may be necessary to complement these pumps with additional pumping stations somewhere out in the system. Figure 10 is a schematic representation of the summer and winter pressure conditions in an idealised district heating system.

The pumping power needed to provide the required head can be calculated from the water flow, pump head and pump efficiency. It is given by the following equation:

$$P = \frac{\dot{V} \cdot \Delta p}{\eta}$$

where  $P$  = pump power in W  
 $\Delta p$  = pump head in Pa  
 $\dot{V}$  = water flow in m<sup>3</sup>/s  
 $\eta$  = pump efficiency

Equations (1) and (2) showed that the pressure drop is proportional to the square of the water flow velocity. This means that, in a given pipe, the pump drive power is proportional to the cube of the flow velocity. The result is that pump drive power increases rapidly with increasing water velocity in the system. This is another reason for trying to limit the increase in water flow rate as the outdoor temperature falls (= increasing load) by raising the supply main temperature.

### Pressurization in district heating systems

At times during the winter, the hot water temperature in a district heating system can exceed 100 °C. This is one of the reasons why it is essential to maintain the whole system under pressure. It is important that the static pressure in the system is sufficiently high, as otherwise there is a risk (e.g. in the event of loss of power to the circulation pumps) of steam formation in the system. Static pressure is determined so that there is as great a degree of freedom as possible in normal operation of the system. The maximum permissible pressure in the system will occur at a low point near to the pressure side of the pumps (= high pressure in the supply main), while the lowest permissible pressure in the system will be at a high point near the suction of the pumps (= low pressure in the return main). Figure 11 shows schematically how pressure-holding can be arranged in a district heating system. The diagram also shows where the highest and lowest permissible pressures will occur in the system. The system can be pressurized, for example, by maintaining the system expansion vessel under pressure and connecting it to the pressure side of the main circulation pumps.

The circulation pumps require a certain minimum NPSH. This means that they should be installed at a level which is safely below the level equivalent to the pressure in the return main immediately before the pumps. It is therefore good practice to install the distribution pumps as low as possible, particularly in district heating systems supplying a level area, or where the production plant is sited relatively high up. This ensures as wide an operating pressure range as possible.

### Economic water velocity

It is important, when dimensioning a piping system, to attempt to minimise not just the capital cost, but the sum of the capital cost, operating costs and maintenance costs of the piping system and pumps. Relatively small pipes will result in high pumping costs and vice-versa. There is therefore an economic optimum for the choice of pipe size for a given flow. However,

## ATTACHMENT A

during the life of a distribution system, the flow will vary from year to year, particularly during the initial years of establishing and expanding the system. Proper economic optimisation should also take account of this.

The major cost items included in economic optimisation are the investment costs of the pipes and pumping stations, together with the cost of the necessary pumping energy and of the heat losses from the system. Other costs must also be considered, e.g. those incurred in preventive maintenance. Figure 12 shows these costs for a main pipe to meet a given heat flow requirement and given temperature difference. It can be seen from the diagram that the capital cost of the pipe falls with decreasing pipe size (increasing water velocity), although the capital cost of the pumping station is not particularly dependent on the pipe size, while the cost of pump drive energy increases sharply with increasing water flow velocity (reduced pipe size). The table below shows guide values for economic water velocities. These values vary depending on the assumptions that are made. But the total cost does not vary significantly over a reasonable range on either side of the optimum point (i.e. the shape of the cost curve has an extended minimum).

Nominal pipe size, mm	32	40	50	65	80	100	125
Water velocity, m/s	0.9	1.0	1.2	1.4	1.5	1.8	2.0
Nominal pipe size, mm	150	200	300	400	500	600	and above
Water velocity, m/s	2.2	2.5	2.6	2.7	2.9	3.0	

These economically suitable water flow velocities should be taken as the average values in a distribution system. However, particularly when dimensioning service connections, allowance should also be made for

## ATTACHMENT A

subscribers' positions in the system as a whole, i.e. whether the connection is close to the distribution pumps (in pressure terms) or not. A relatively large differential pressure is available at the service connections of consumers situated close to the pumps, which means that such service connections could be one size smaller than indicated by the rule-of-thumb sizes. On the other hand, the same consumers at the outer extremities of the distribution system might require a service connection one size larger than the size in the table. Such factors should be considered when carrying out a true optimisation, which will also ensure that the available pressure drops for all consumers are as similar as possible.

Aids for flow calculations

When performing flow calculations, it is necessary to use aids in the form of tables and diagrams of such factors of hydraulic resistance and friction factors in order to arrive at suitable starting values. A pressure drop calculation for a simple system having radial distribution can then be worked out manually from the tables or diagrams. For more complicated systems, having several supply loops, such manual calculation is particularly time-consuming. It requires repeated trial-and-error calculation in order to arrive at the correct differential pressures at points which can be supplied by water arriving via two or more routes. Computer programs are now available for more complex calculations of this type.

ATTACHMENT A

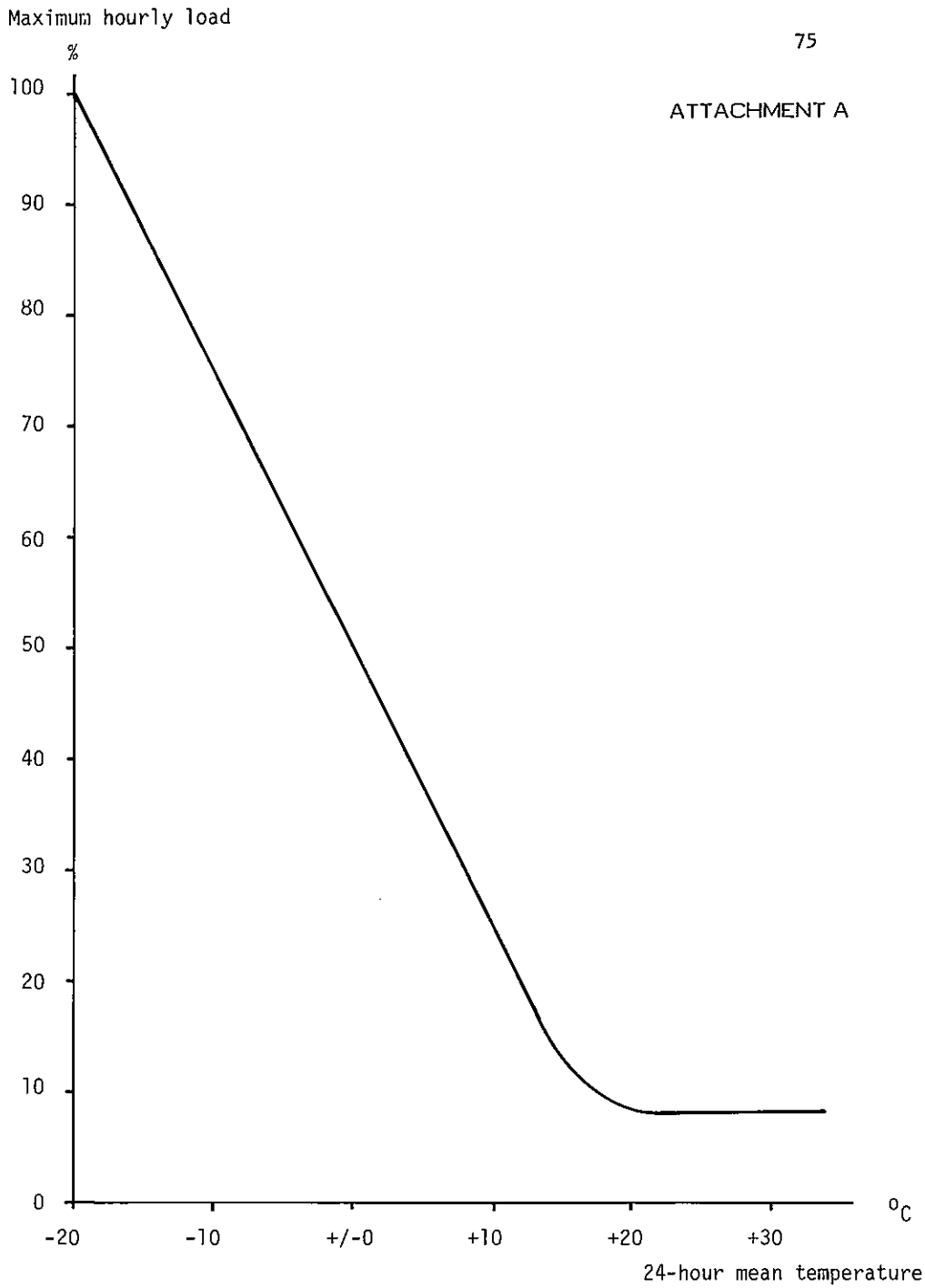

Figure 1 - Dimensioning of piping system

Example of relative heat load as a function of outdoor temperature.

Generalised characteristic

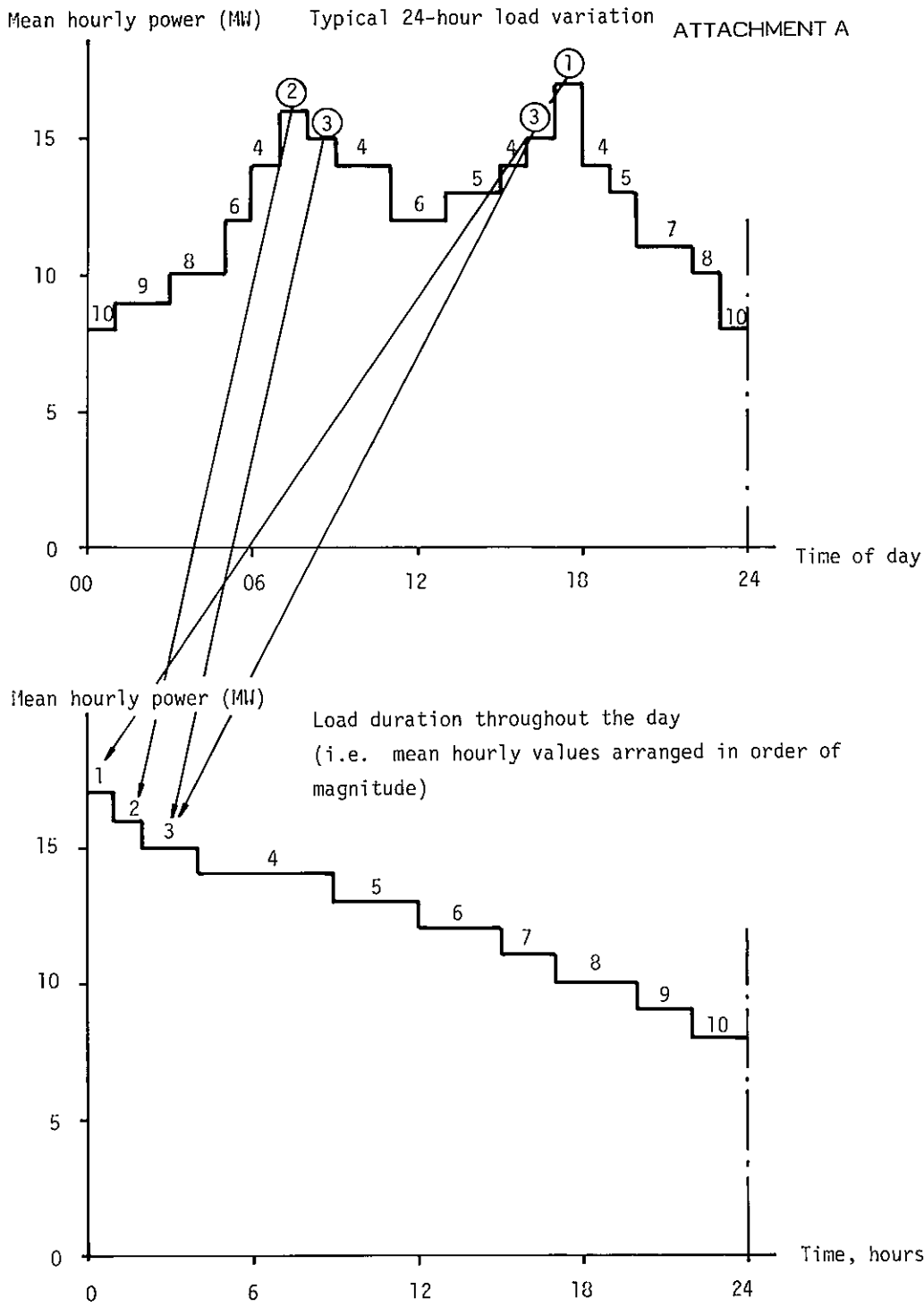

Figure 2 - Dimensioning of piping system  
Assembly of a load duration diagram

Mean hourly loading

77

ATTACHMENT A

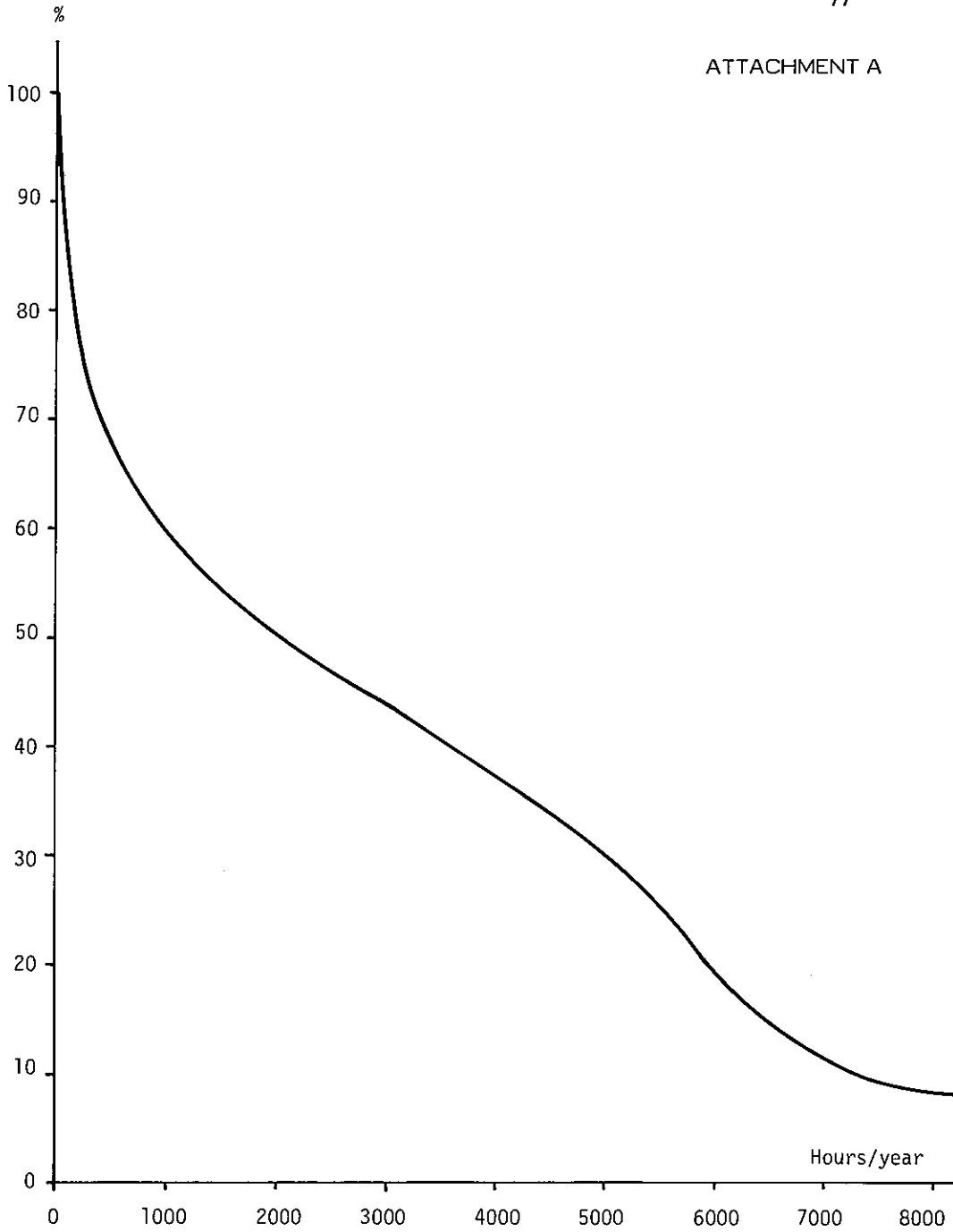

Figure 3 - Dimensioning of piping system

Annual load duration diagram, as seen at the production plant.

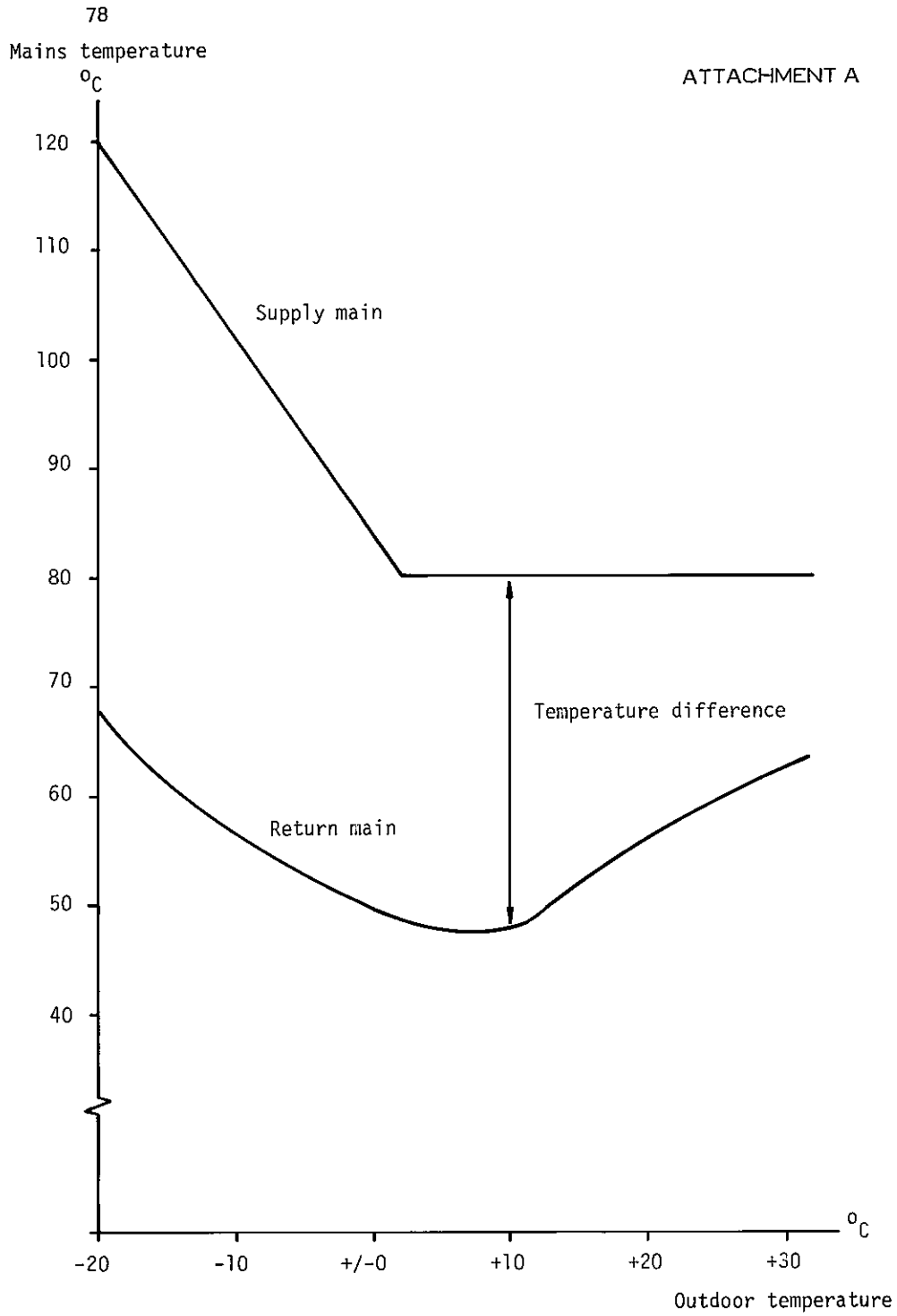

Figure 4 - Dimensioning of piping system

Example of supply main temperature characteristic and typical return main temperatures as a function of outdoor temperatures.



## ATTACHMENT A

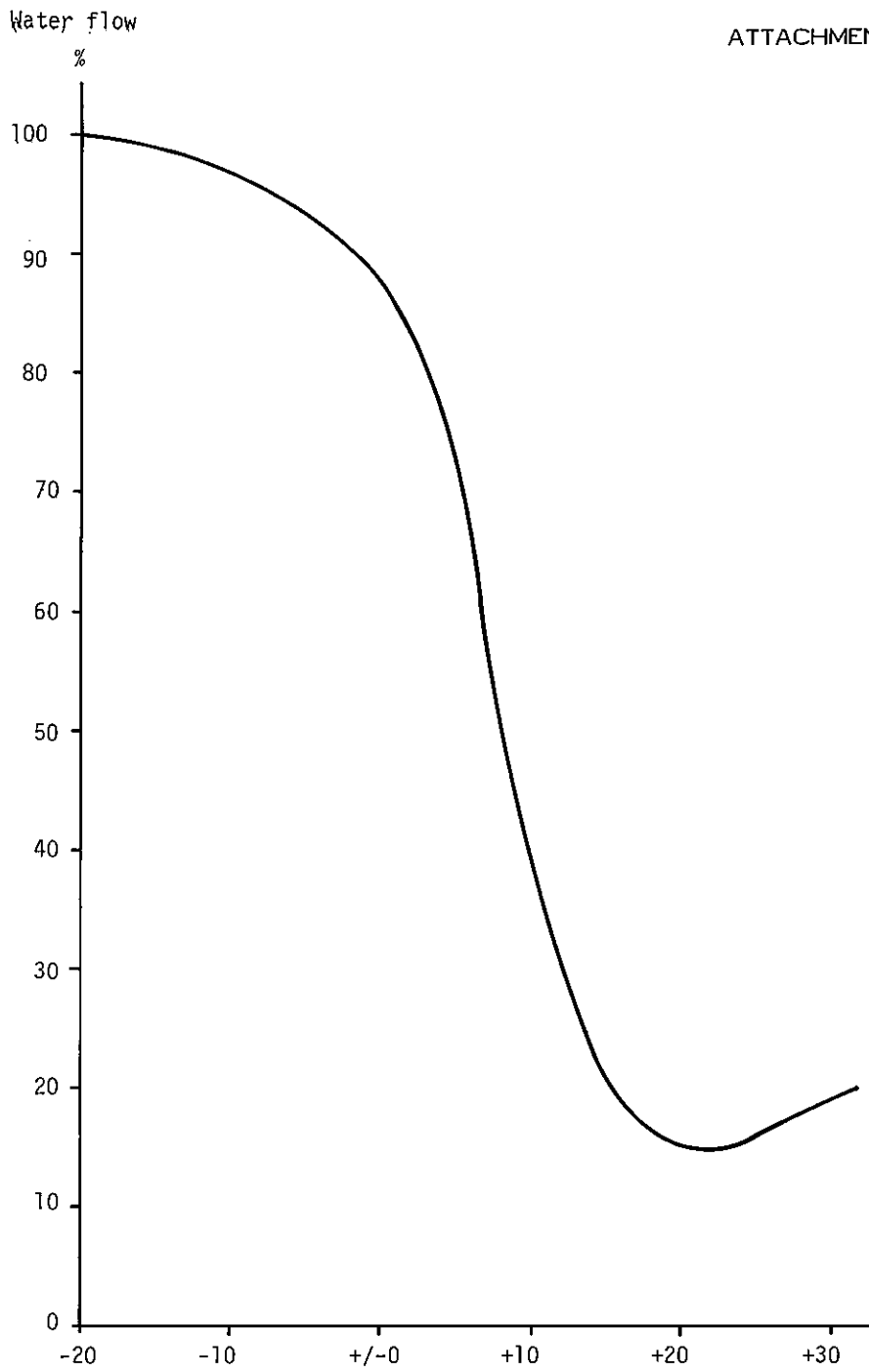

Figure 5 - Dimensioning of piping system

Example of relative water flow as a function of outdoor temperature.

Generalised curve.

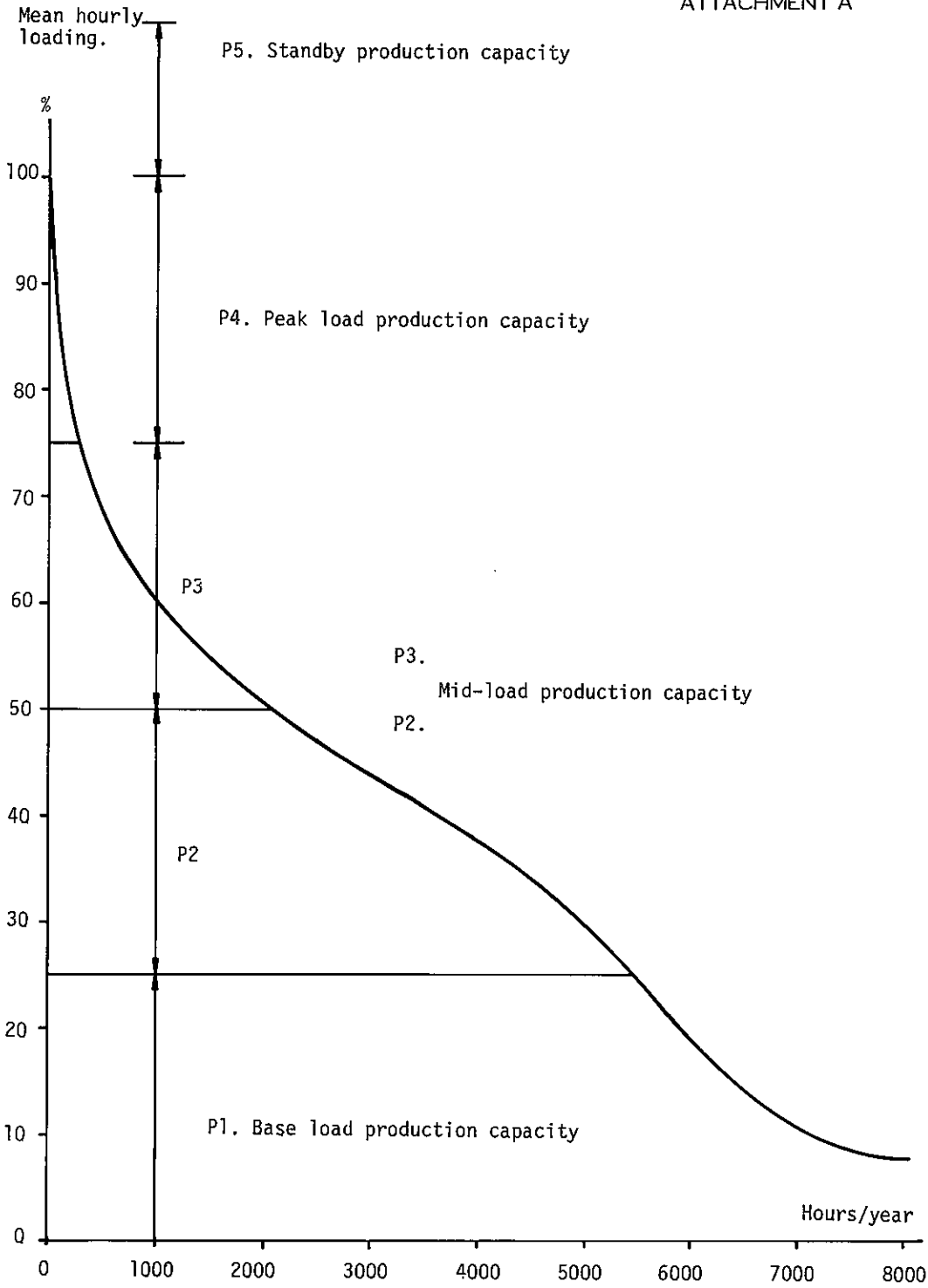

Figure 6 - Dimensioning of piping system  
Production sources and load duration curve.

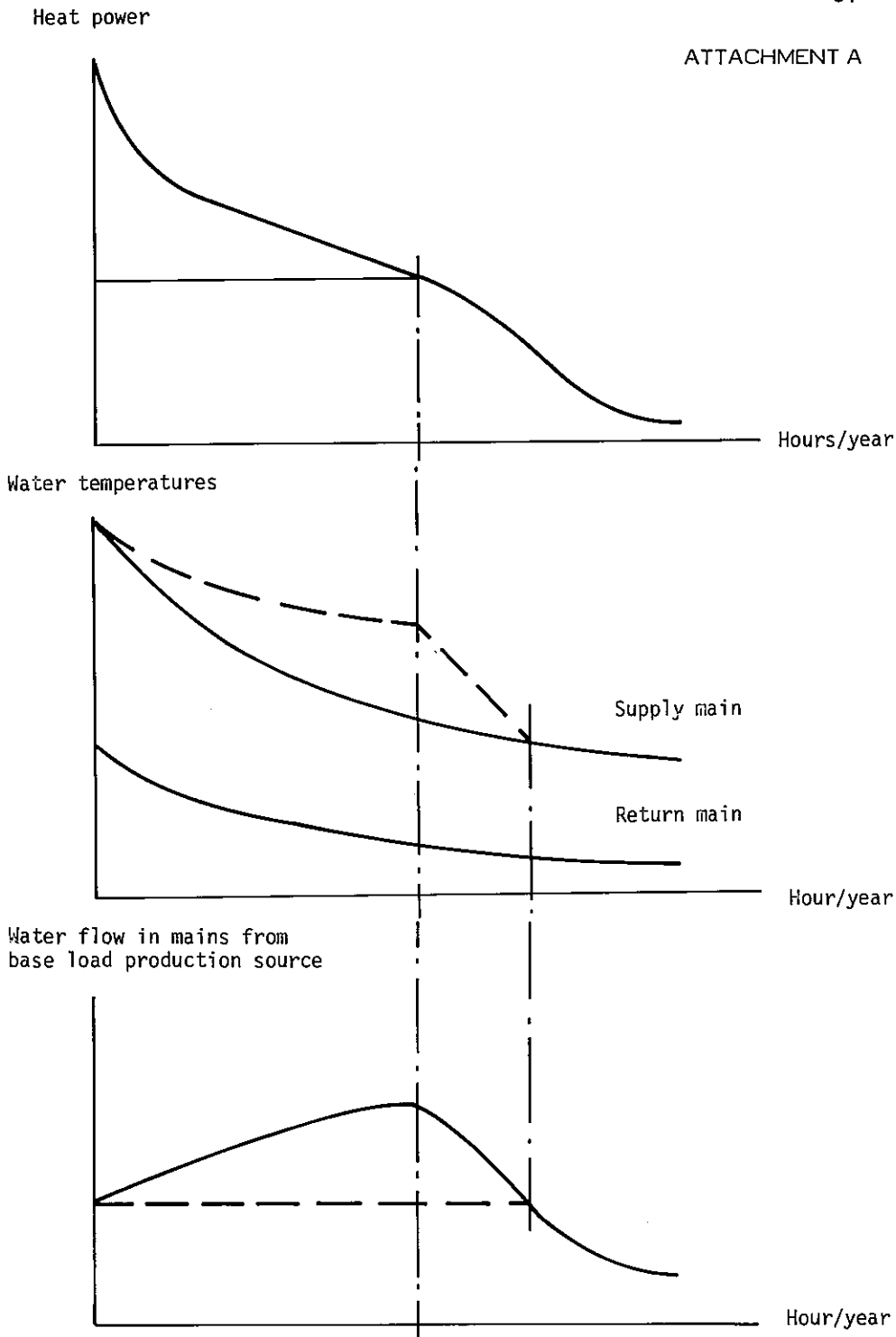

Figure 7 - Dimensioning of piping system

Base load production at one end of a district heating distribution system network.  
Generalised curves.

$d/k = \text{pipe diameter/surface roughness}$

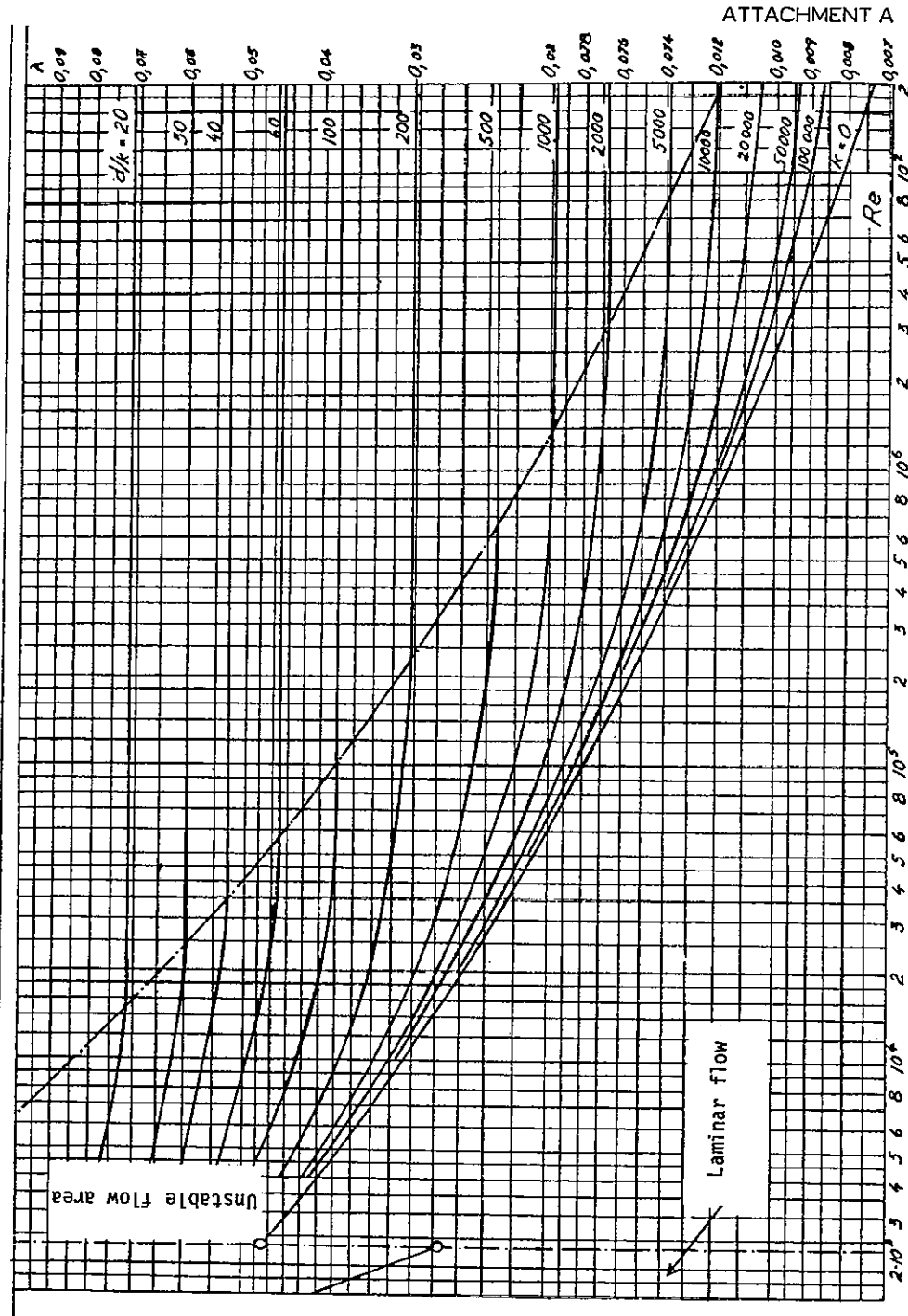

Figure 8 - Dimensioning of piping system  
Friction factor  $\lambda$  for flow in pipes.

## ATTACHMENT A

Values of hydraulic resistance for flow in pipes.

DEFINITION:  $\Delta p = \xi \cdot \frac{\rho \cdot w^2}{2}$  Pa

Pipe bends The figures below are for 90° bends:  
for other angles,  $\xi$  is proportional  
to the angle.

R/D	$\xi$	
1.0	0.4	These values should be multiplied by
1.5	0.3	1.5 for lobster-back bends (i.e. for
2.0	0.2	non-prefabricated bends).

Branches

These values are arbitrary values.

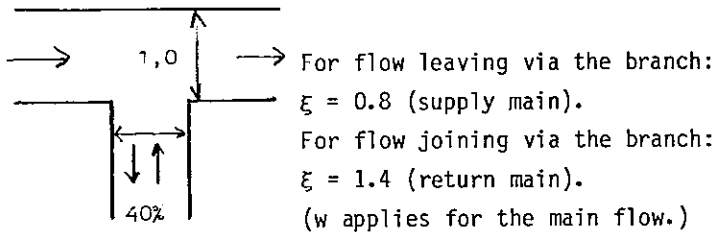

Valves

$\xi = 0.2$  for, say, a fully open plug valve.

Changes in cross-sectional area

These values are arbitrary values.

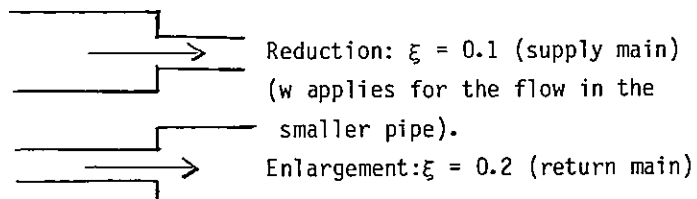

Figure 9 - Dimensioning of piping system

ATTACHMENT A

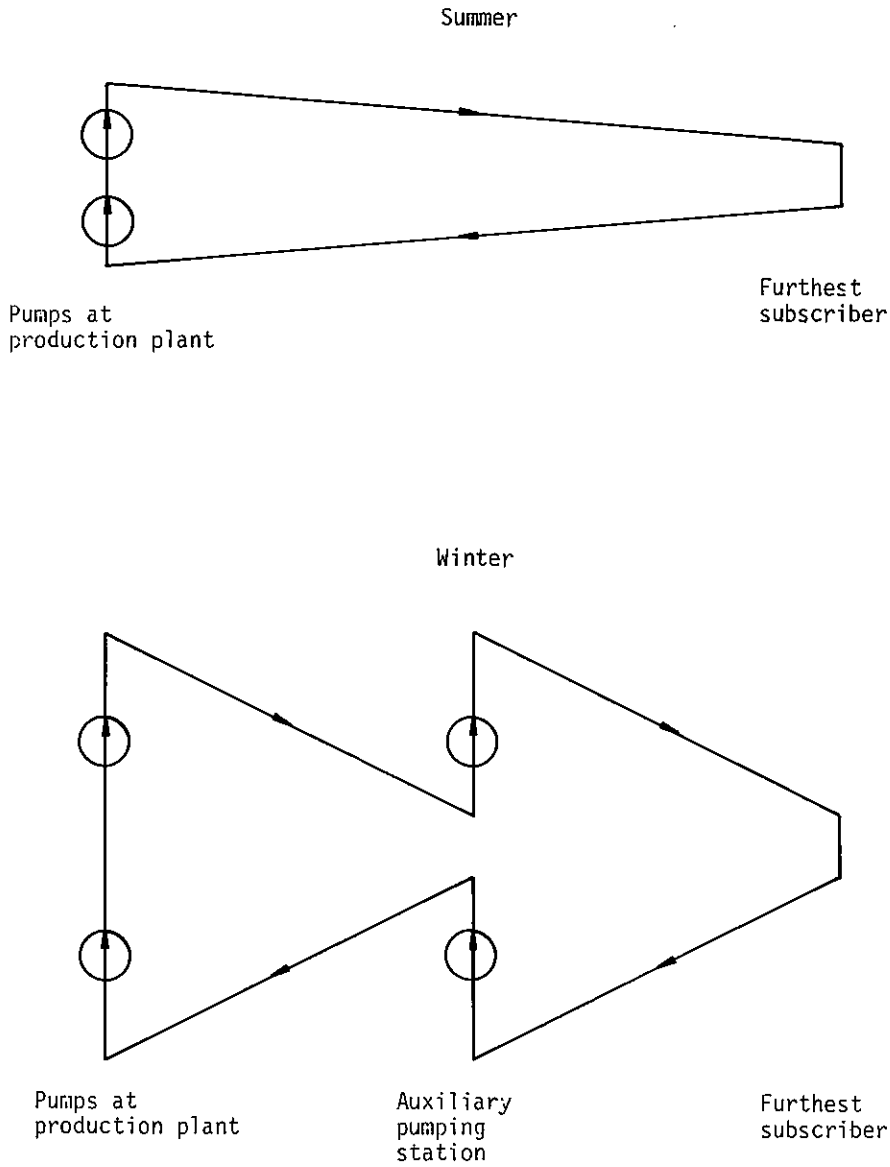

Figure 10 - Dimensioning of piping system

Pressure head and pressure drop in a district heating distribution system.

Generalised diagrams.

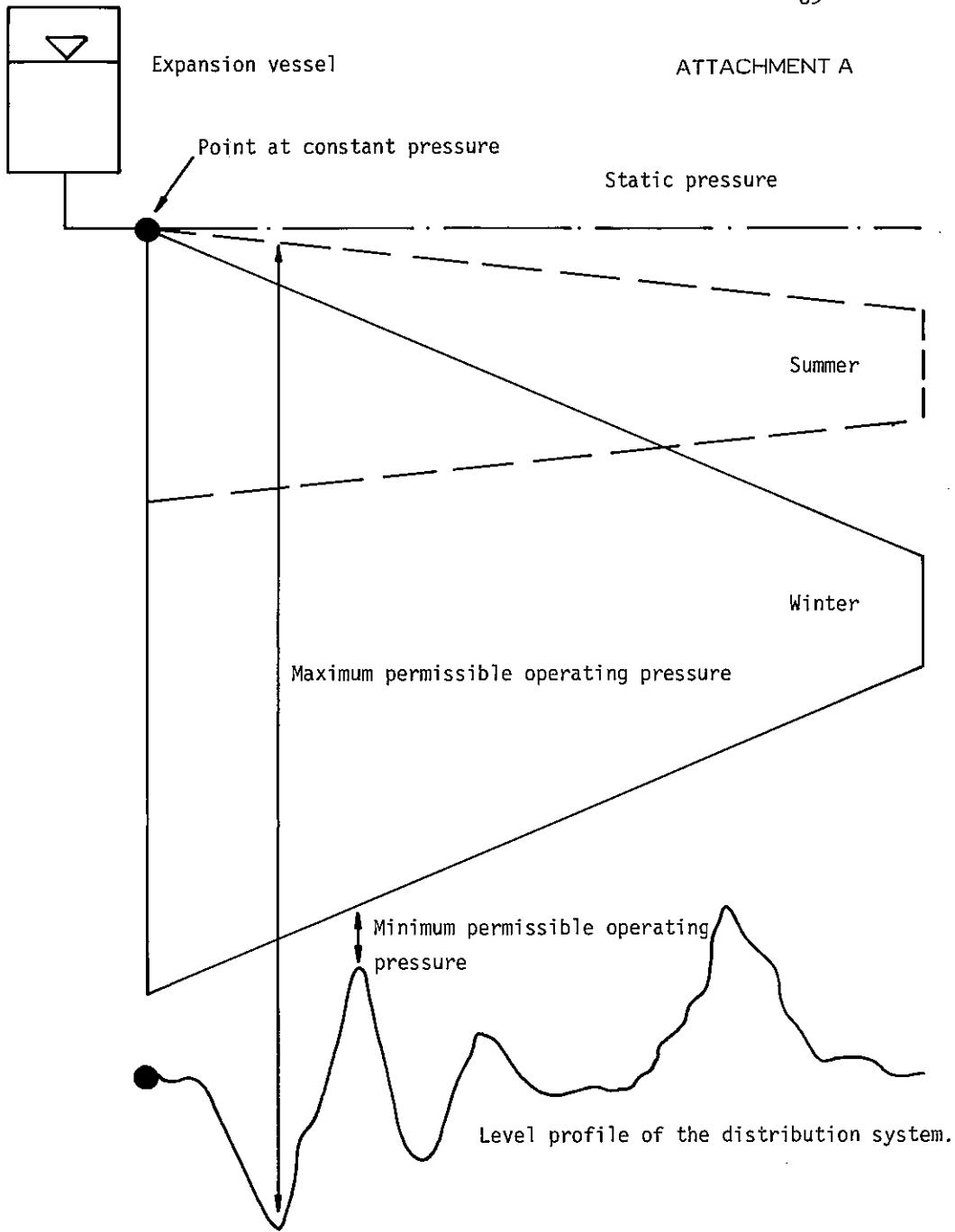

Figure 11 - Dimensioning of piping system

Example of pressure maintenance in a district heating distribution system.

Relative total transport cost.

ATTACHMENT A

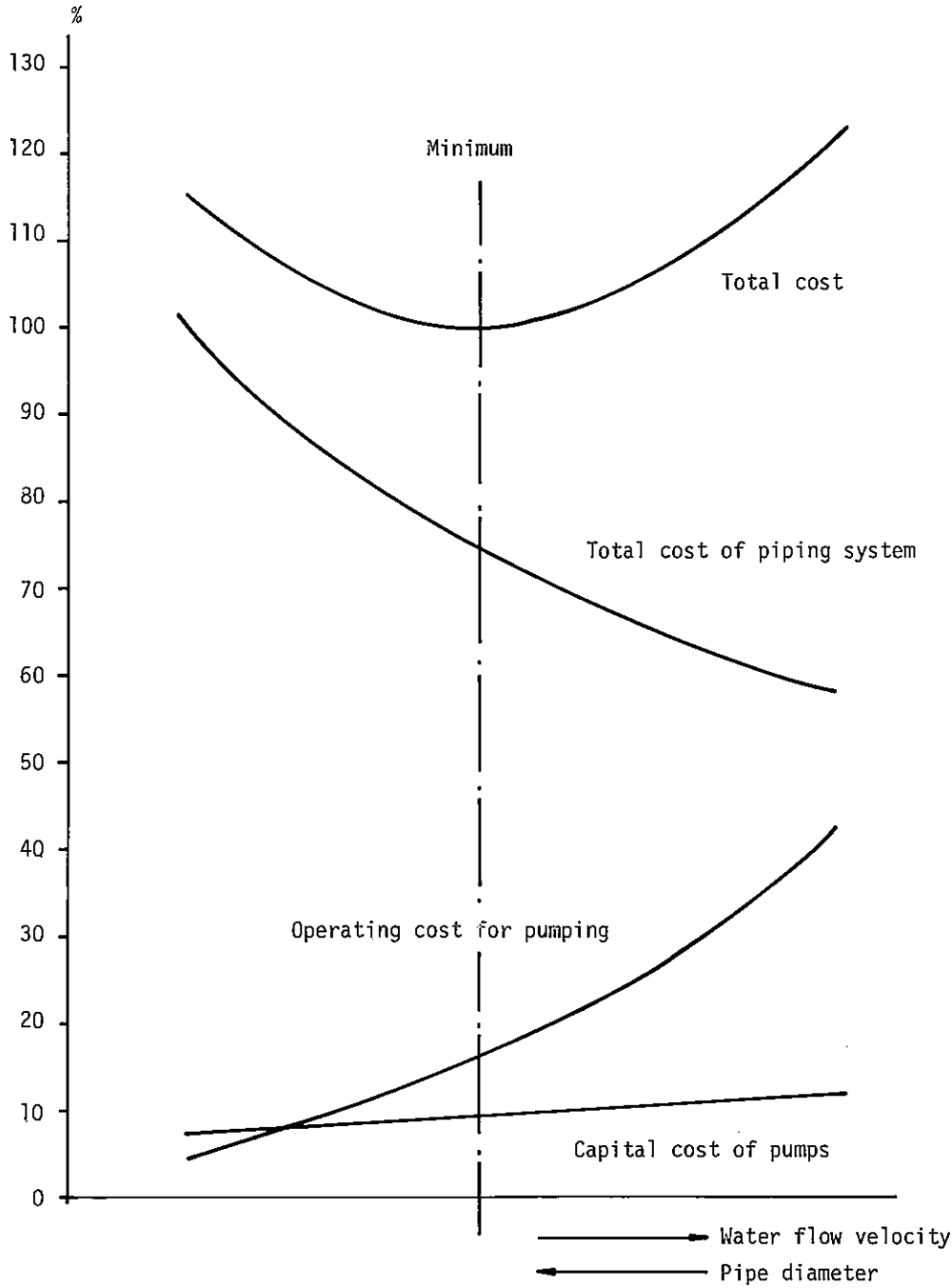

Figure 12 - Dimensioning of piping system

Determination of economic water flow velocity.

Generalises example.

This diagram applies for a given heat transfer power capacity and a given temperature difference.



Survey of specific pipeline costs

Specific pipeline cost/institution included

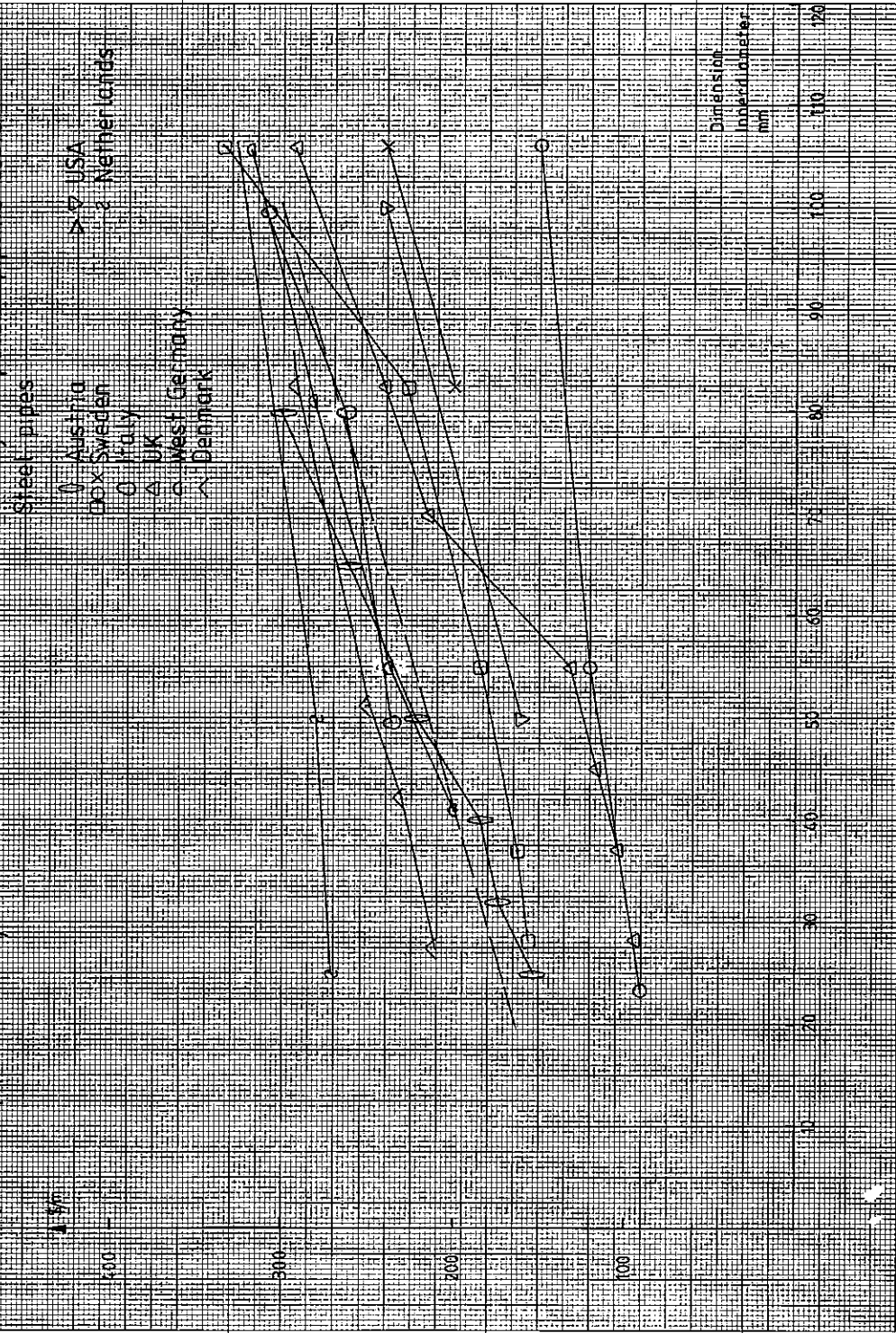

Survey of specific pipe line costs  
Steel pipes

Specific pipe line costs, installation included

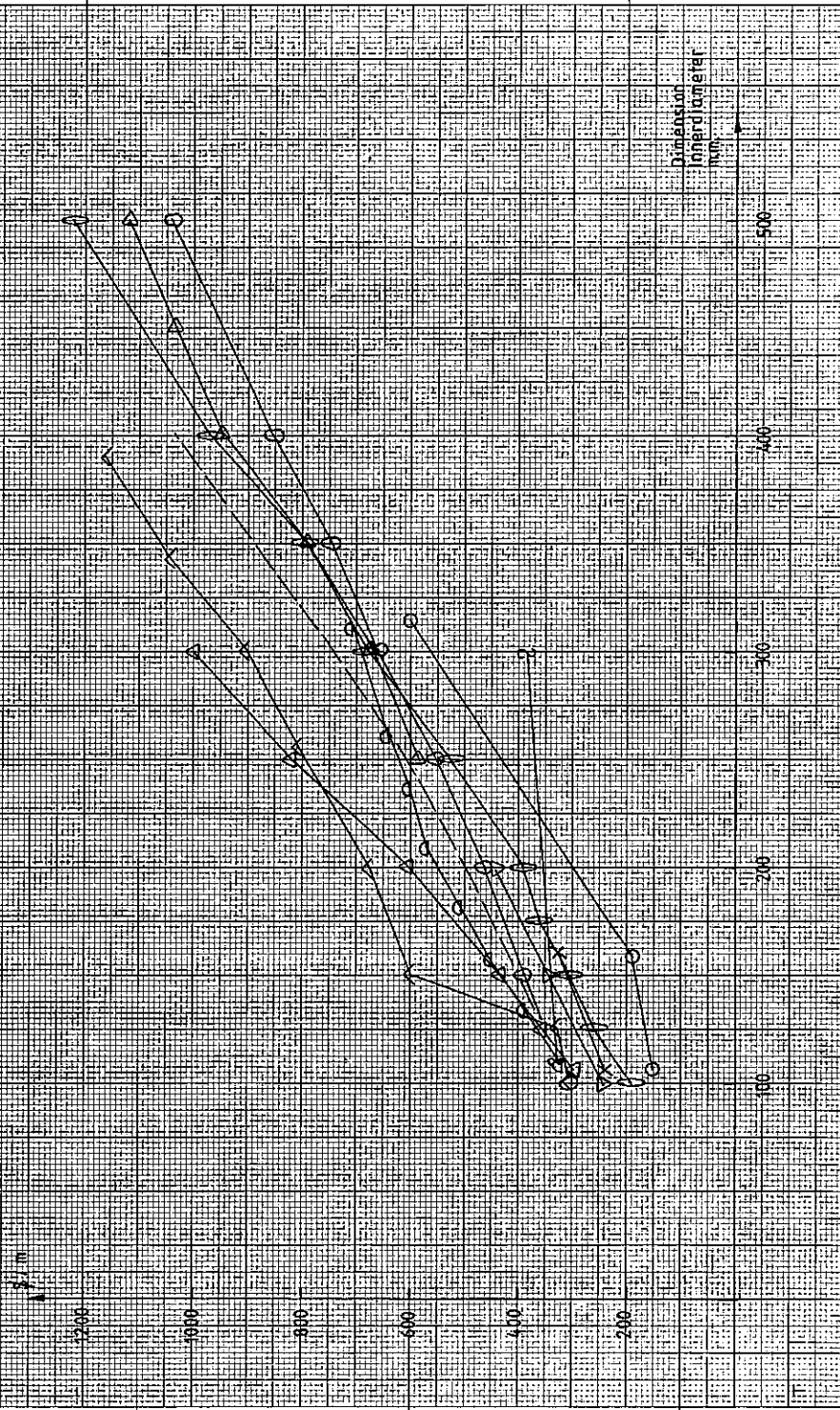

STEEL PIPELINES

Further basic information

Symbol	Insulation Type	Insulation Thickness mm	Heat losses kWh/m, year $\Delta t=70^{\circ}\text{C}$	Max.pressure MPa(e)	Max.temperature $^{\circ}\text{C}$	Participating country	Remarks
□	PU	$d_i = 28$	43	1.6	120	Sweden	
		$d_i = 55$	37				
		$d_i = 107$	53				
○	PU	$d_i = 22$	39	1.6	120	Sweden	
		$d_i = 55$	37				
		$d_i = 107$	39				
		$d_i = 315$	54				
X	PU	$d_i = 107$	50	1.6	120	Sweden	
		$d_i = 220$	220				
⊖	MW	$d_i = 50$	50,60*	1.6	140	Italy	
		$d_i = 100$	60,50				
		$d_i = 300$	90,60				
		$d_i = 500$	100,70				
△	MW	all $d_i$	50	0.5	150	UK	The specific pipeline costs are the doubled single pipe costs given by the participant. Furthermore, building work etc. is excluded.

STEEL PIPES

Further basic information

Symbol	Insulation Type	Insulation Thickness mm	Heat losses kWh/m, year $\Delta t = 70^{\circ}\text{C}$	Max pressure MPa(e)	Max temperature $^{\circ}\text{C}$	Participating Country	Remarks	
◐	PU	$d_i = 55$	400	1.6	130	West Germany		
		$d_i = 107$	520					
		$d_i = 312$	890					
◑	PU	$d_i = 42$	170	1.6	130	Denmark		
		$d_i = 100$	280					
		$d_i = 254$	500					
◒	PU	$d_i = 50$	160	1.0	260	USA	It is not very likely that PU-insulation can stand a temperature of $260^{\circ}\text{C}$	
		$d_i = 100$	490					
		$d_i = 200$	740					
◓	CS	$d_i = 250$	820	1.0	330	USA		
		$d_i = 500$	1480					
?	PU	$d_i = 25$			100	The Netherlands		
		$d_i = 55$						
		$d_i = 110$						
		$d_i = 300$						

Remarks: MW = mineral wool  
 PU = polyurethane  
 CS = calcium silicate

\* supply and return pipes.

Survey of specific pipe line costs  
Copper pipes

Specific pipe line costs

\$/ft

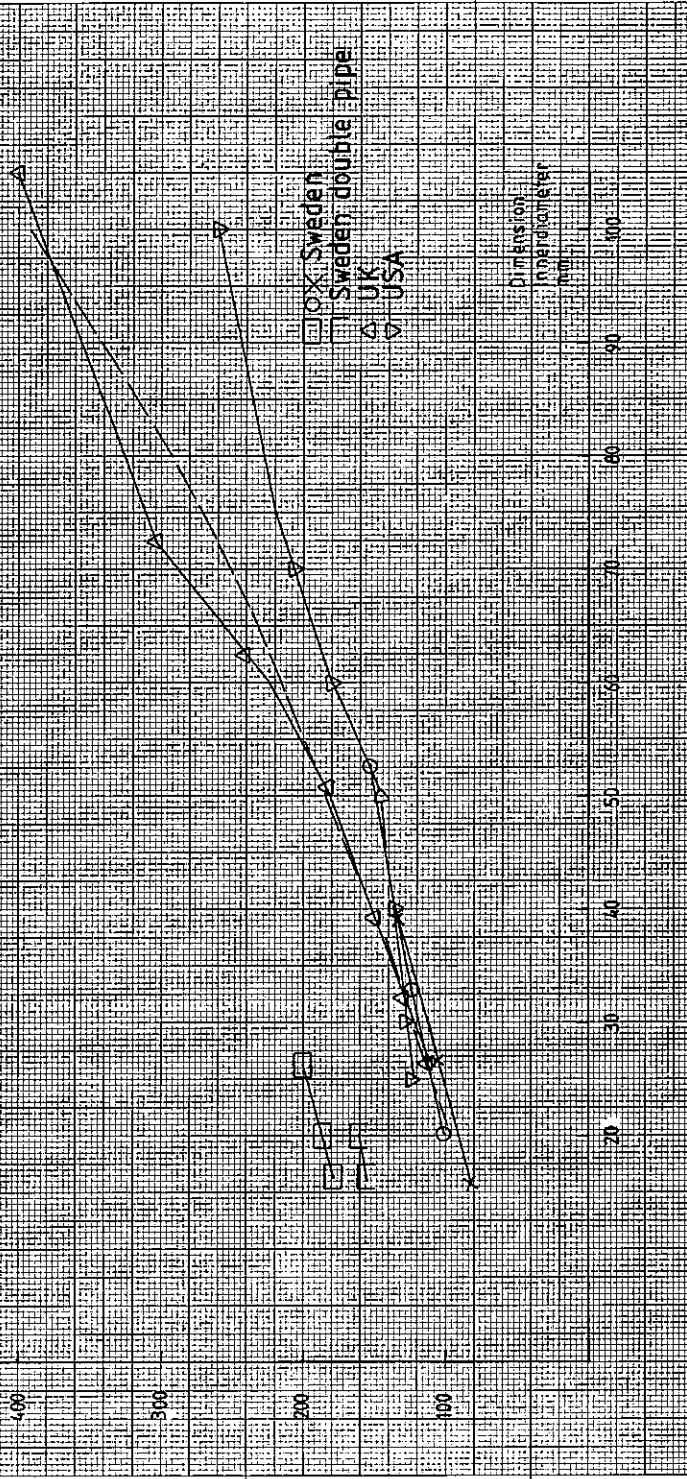

Legend:  
□ Sweden  
△ UK  
○ USA

Legend:  
□ Sweden  
△ UK  
○ USA

Legend:  
□ Sweden  
△ UK  
○ USA

Legend:  
□ Sweden  
△ UK  
○ USA

Legend:  
□ Sweden  
△ UK  
○ USA

Legend:  
□ Sweden  
△ UK  
○ USA

Legend:  
□ Sweden  
△ UK  
○ USA

Legend:  
□ Sweden  
△ UK  
○ USA

COPPER PIPELINES

Further basic information

Symbol	Insulation Type	Insulation Thickness mm	Heat losses kWh/m <sub>0</sub> year $\Delta t = 70^{\circ}\text{C}$	Max pressure MPa(e)	Max temperature $^{\circ}\text{C}$	Participating Country	Remarks
□	MW	d <sub>i</sub> = 20 29	170	1.6	120	Sweden	
○	MW	d <sub>i</sub> = 20 29 d <sub>i</sub> = 20 43	210 280	1.6	120	Sweden	
×	MW	d <sub>i</sub> = 16 31 d <sub>i</sub> = 39 49	85 210	1.6	120	Sweden	
△	MW	all d <sub>i</sub> 50		0.5	150	UK	The specific pipe-line costs are the doubled single pipe costs given by the participant. Furthermore, building etc. work is excluded.
▽	PU	d <sub>i</sub> = 25 25 d <sub>i</sub> = 50 25 d <sub>i</sub> = 100 25	130 220 400	1.0	125	USA	
□	MW	d <sub>i</sub> = 20 40	100	1.6	120	Sweden	Double pipes in one cover

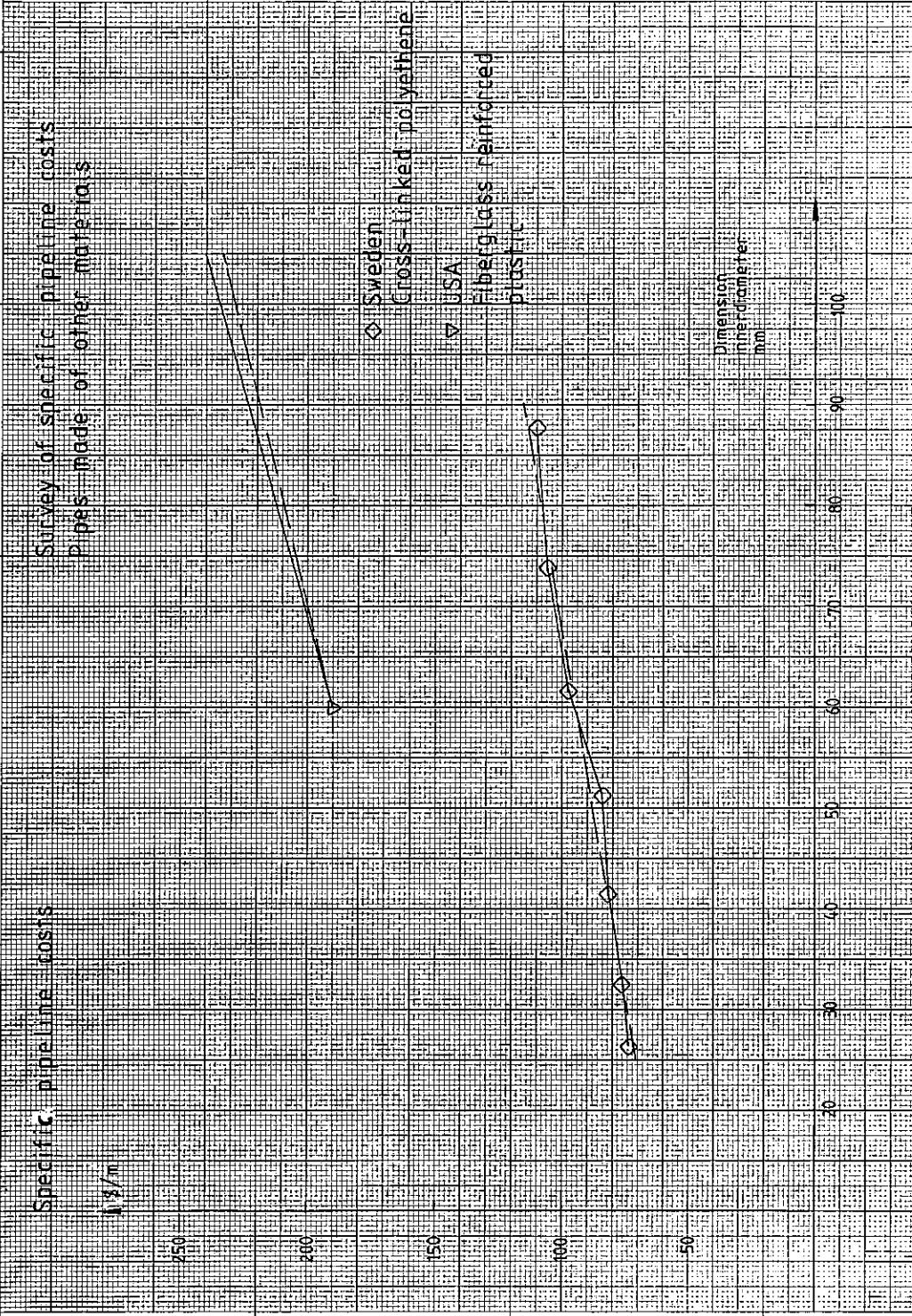

Survey of specific pipe line costs  
Pipes made of other materials

Specific pipe line costs

\$/m

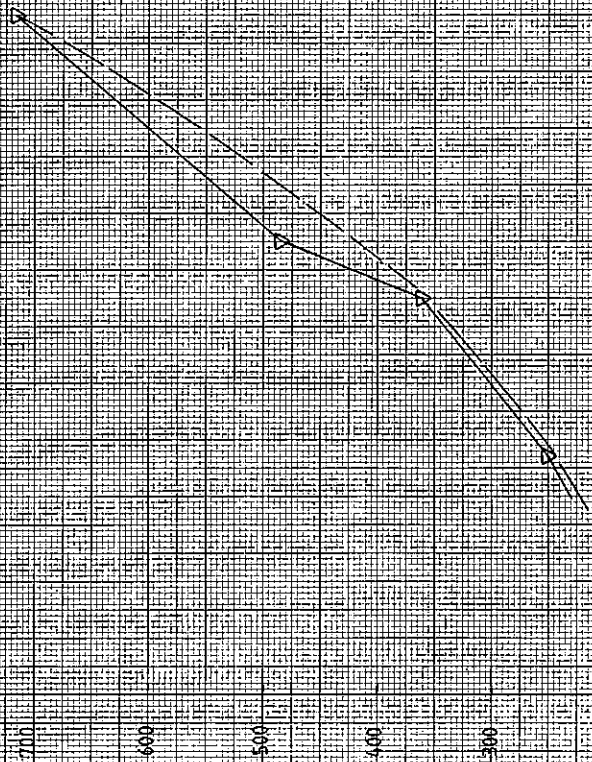

Dimensions  
in millimeters  
mm

↑

500

400

300

200

100

0



PIPES MADE OF OTHER MATERIALS

Further basic information

Symbol	Material	Insulation Type	Thickness mm	Heat losses $\Delta t=70^{\circ}\text{C}$	Max.pressure MPa(e)	Max.temperature $^{\circ}\text{C}$	Participating country	Remarks
◇	Cross-linked polyethylene	MW	all $d_i$ 100		0.6	80	Sweden	Specific pipe line prices are excluding pavement restoration.
▽	Fiber-glass reinforced plastic	PU	$d_i = 60$ 40 $d_i = 110$ 20 $d_i = 200$ 20	115 330 580	1.0	120	USA	

Survey of specific pipeline costs  
Multi pipe culvert

Specific pipe line costs

Steel pipe culvert

1.5/m

600

400

200

Dimension  
inner dia. meter  
m

30 40 50 60 70 80 90 100 110

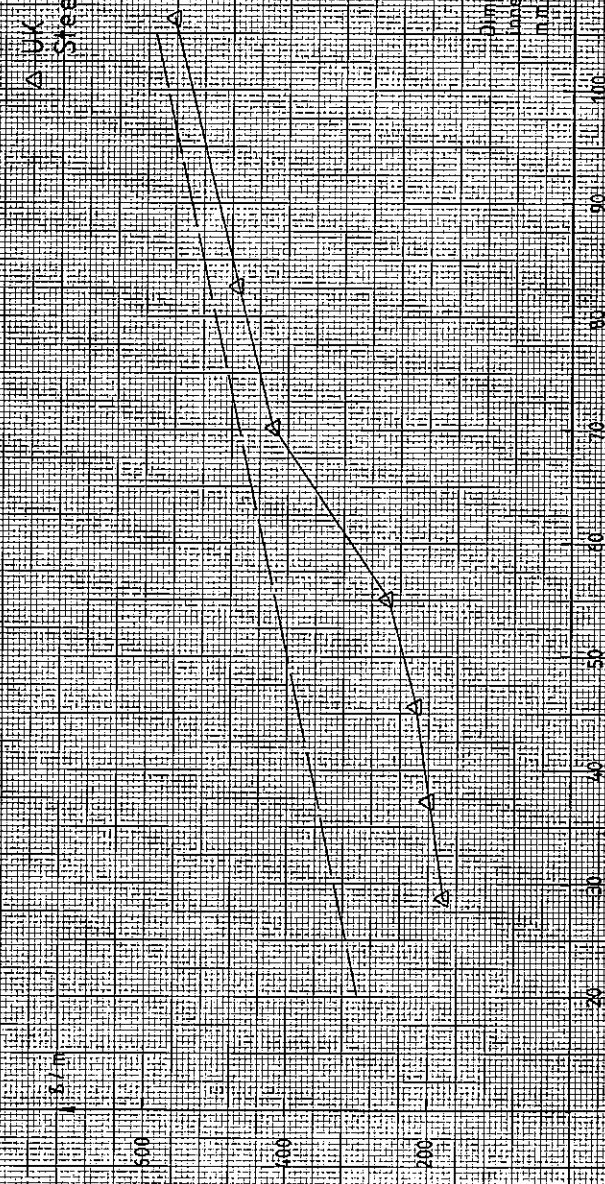

Survey of costs for heat exchangers for domestic heating and tap hot water

Costs, heat exchange and installation

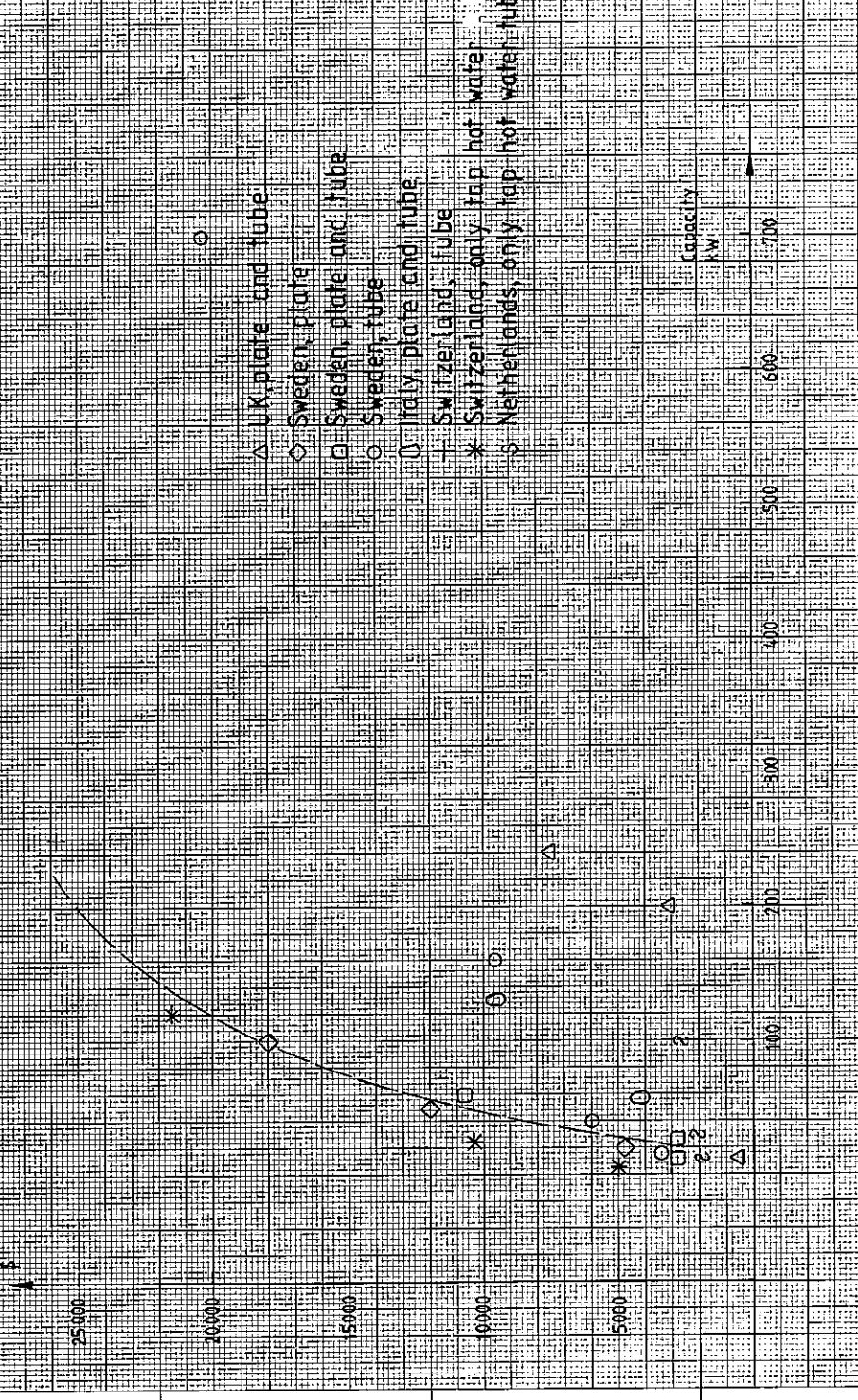

Survey of costs for heat exchangers  
for heating of storage

Costs

20000

15000

10000

5000

+ Switzerland, tube  
▽ USA, tube  
○ Netherlands, tube

Capacity  
kW

500

200

500

200

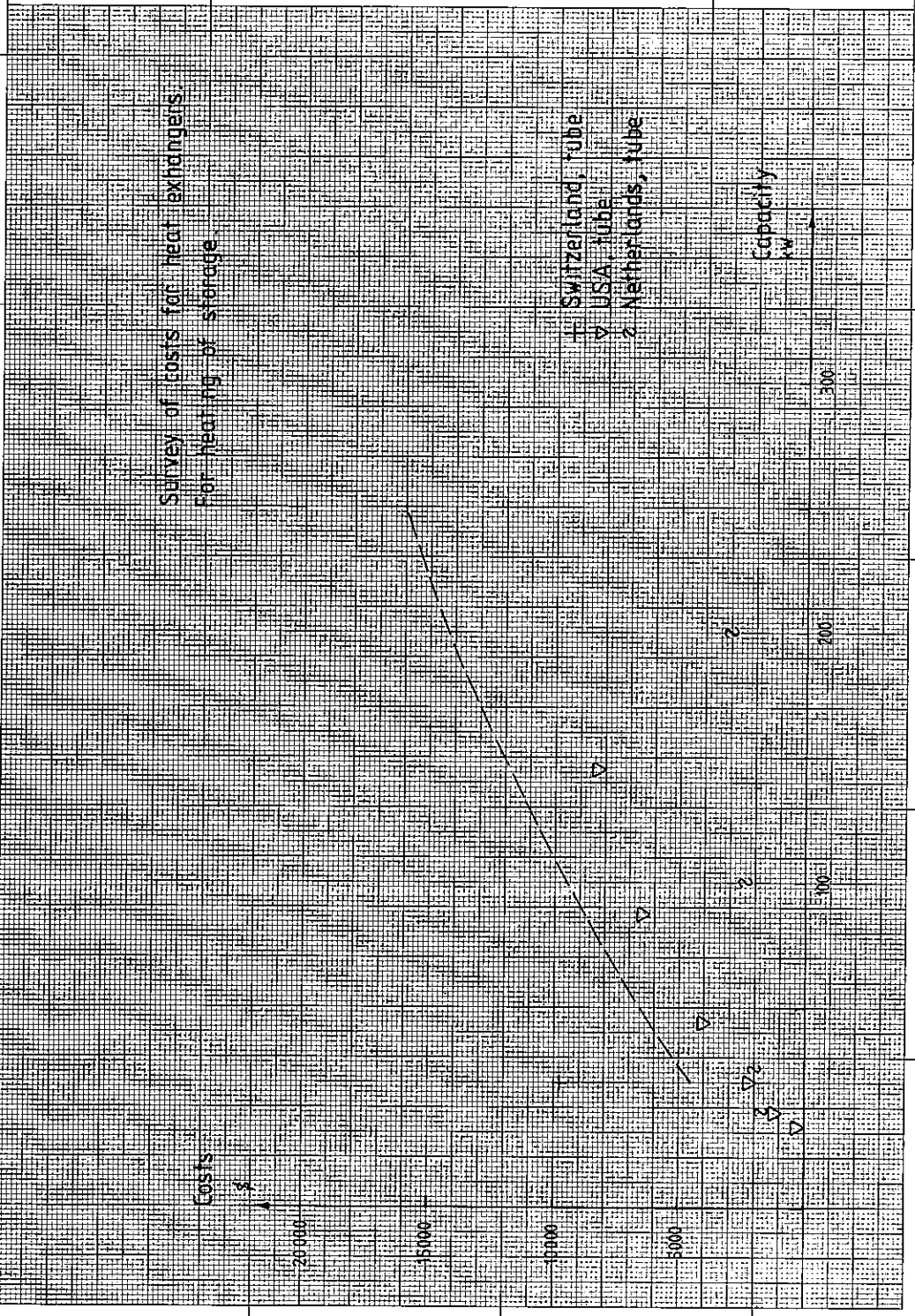

Survey of costs for pumps

P=11.6 kW

Costs, pump and installation

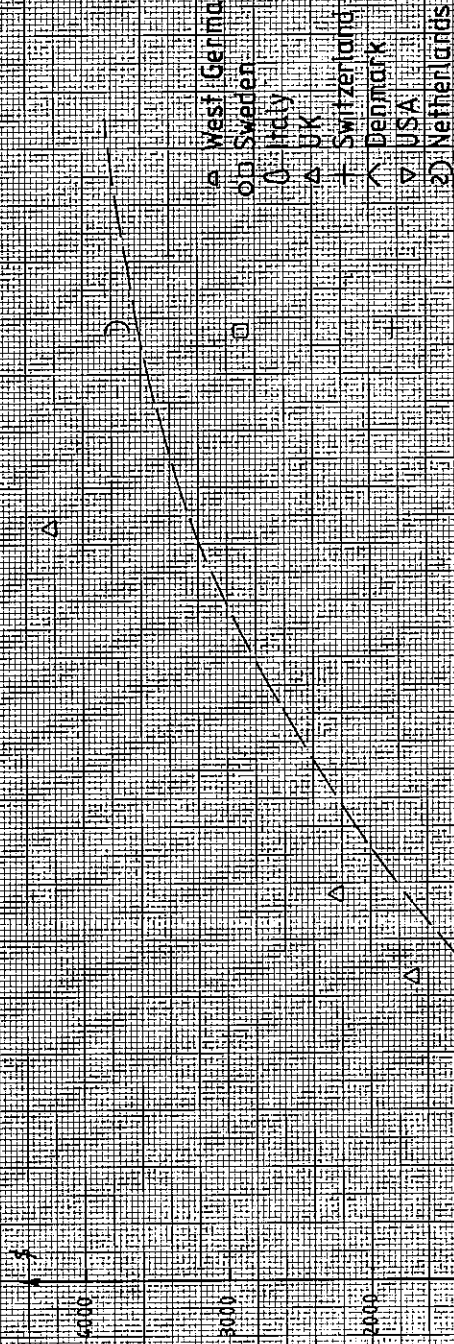

power  
kW

Survey of costs for pumps P# 6-1600 KW

Costs, pump and installation

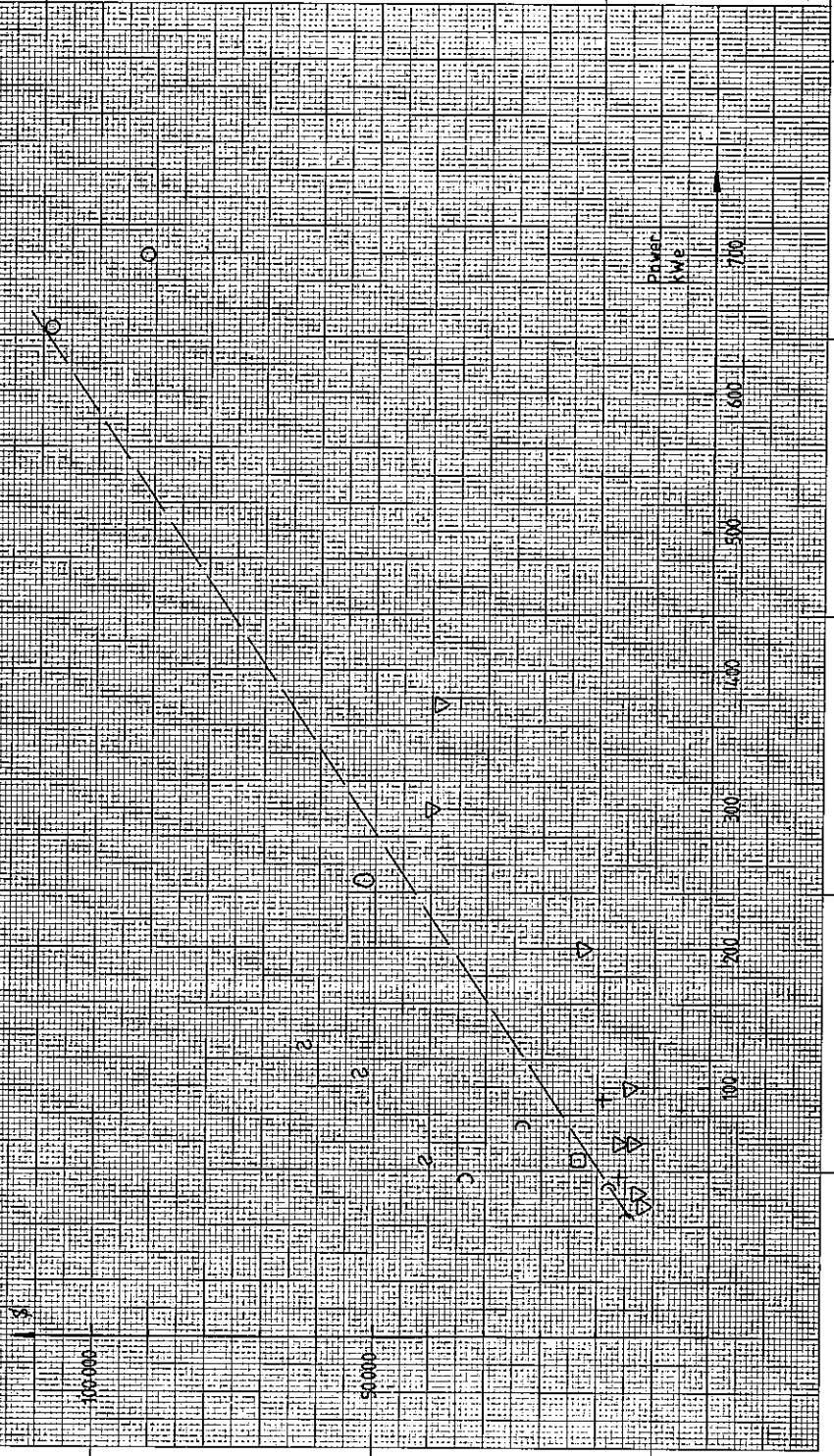

## ATTACHMENT G2

PUMPS

## Further basic information

Symbol	Participating country	Control	Remarks
—			
◐	West Germany	3-step	
□	Sweden	-	Control and electrical installation excluded
○	Sweden	650 kW:hydraulic clutch 700 kW:thyristor	
◊	Italy	Hydraulic clutch	
△	UK	-	Control excluded
+	Switzerland	-	Control excluded
∧	Denmark	-	Control excluded
▽	USA	Constant speed	Control excluded
?	The Netherlands	Variable speed	
)	The Netherlands	Constant speed	Control excluded



Survey of costs for heat meters

Costs, heat meter and installation

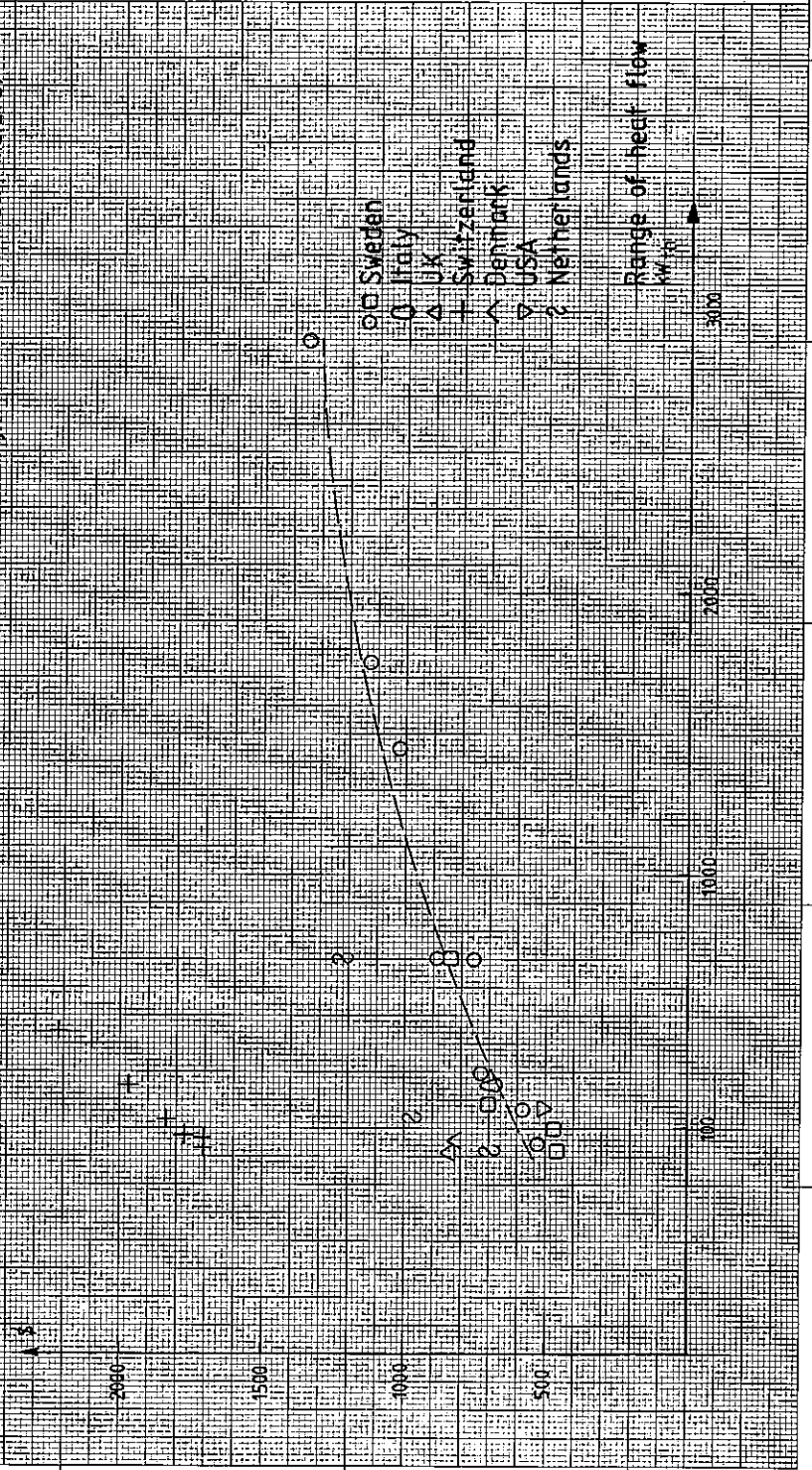



## ATTACHMENT H2

HEAT METERS

## Further basic information

<u>Symbol</u>	<u>Participating country</u>	<u>Maintenance costs % of investment costs per year</u>
□	Sweden	10.5 - 11.5
◊	Italy	
△	UK	20
+	Switzerland	
∧	Denmark	5
▽	USA	10 - 15
?	The Netherlands	7

## LIST OF PARTICIPANTS

Austria	Günter Spielmann	Austrian Institute for Building Research
Canada	Ronald C. Biggs	National Research Council of Canada
CEC	Dolf van Hattem	Ispra Research Center
Denmark	Kurt K. Hansen	Technical University of Denmark
Federal Republic of Germany	Heinz Riemer	Kernforschungsanlage Jülich
The Netherlands	Cees den Ouden	Institute of Applied Physics - TNO
Sweden	Tomas Bruce	Södertälje Energy Supply Authority
Switzerland	Pierre Chuard	Sorane S A
United Kingdom	Robin LaFontaine	Oscar Faber and Partners
United States	Allen Davis	Korba Engineering Company

This report is part of the work within the IEA Solar Heating and Cooling Programme,  
Task VII: Central Solar Heating Plants with Seasonal Storage  
Subtask I d): Heat Distribution System

This report deals with the distribution of energy by means of hot water. The aim is to provide basic design data for the distribution system interconnecting solar collectors, seasonal heat storage and consumers in Central Solar Heating Plants with Seasonal Storage (CSHPSS). Thus the report reviews the present situation of the district heating technology in participating countries, discusses basic assumptions for the heat distribution in a CSHPSS and presents a collection of basic cost data.

---

**Restricted distribution**

Only for distribution within:  
Austria, Canada, Denmark, Germany,  
the Netherlands, Sweden, Switzerland,  
the United Kingdom, the United States  
and the Commission of European Communities.

---

Document D22: 1982  
ISBN 91-540-3819-7

Swedish Council for Building Research  
Stockholm, Sweden