

SHC TASK 47: RENOVATION OF NON-RESIDENTIAL BUILDINGS TOWARDS SUSTAINABLE STANDARDS

SUBTASK C: ASSESSMENT OF TECHNICAL SOLUTION AND OPERATIONAL MANAGEMENT IN CASE STUDIES

IEA SHC Report: T.47.C.Final June 2015



TASK 47: Renovation of Non-Residential Buildings towards Sustainable Standards

SHC TASK 47: RENOVATION OF NON-RESIDENTIAL BUILDINGS TO- WARDS SUSTAINABLE STANDARDS

STC: ASSESSMENT OF TECHNICAL SOLU- TION AND OPERATIONAL MANEGEMENT

Project:

SHC TASK 47: Renovation of non-residential buildings towards sustainable standards

Operating Agent: Fritjof Salvesen

Asplan Viak AS – KanEnergi, P.O.Box 24, 1300 Sandvika, Norway

Phone: +47 4040 7853, E-mail: fritjof.salvesen@asplanviak.no

Subtask C: Assessment of Technical Solutions and Operational Management:

Coordination: Doreen Kalz

Fraunhofer Institute for Solar Energy Systems ISE | Group Building Analysis and Energy Concepts, Heidenhofstraße 2, 79110 Freiburg, Germany

Phone: +49 (0) 761 / 4588-5403, Fax: +49 (0) 761 / 4588-9000, E-mail: Doreen.kalz@ise.fraunhofer.de

Contributors:

Diego Arroyo	AU-University of Sydney, Australia
Richard Hyde	AU-University of Sydney, Australia
Nathan Groenhout	AU-University of Sydney, Australia
Claudia Dankl	Österreichische Gesellschaft für Umwelt und Technik, ÖGUT Austria
Tarik Ferhatbegovic	AIT Austrian Institute of Technology, Austria
Thomas Mach	Graz University of Technology, Austria
Daniel Brandl	Graz University of Technology, Austria
Werner Lerch	Graz University of Technology, Austria
Peter Kautsch	Graz University of Technology, Austria
Severin Zimmer	Graz University of Technology, Austria
Ulrich Ruisinger	Graz University of Technology, Austria
Stefan Holper	FIBAG - Forschungszentrum für integrales Bauwesen AG, Austria
Michael Grobbauer	FIBAG - Forschungszentrum für integrales Bauwesen AG, Austria
Jørgen Rose	Danish Building Research Institute AAU, Denmark
Kirsten Englund Thomsen	Danish Building Research Institute AAU, Denmark
Roman Jakobiak	Daylighting, Germany
Johann Reiss	Fraunhofer Institute for Building Physics, Germany
Arnulf Dinkel	Fraunhofer Institute for Solar Energy Systems, Germany
Benjamin Köhler	Fraunhofer Institute for Solar Energy Systems, Germany
Fabien Coydon	Fraunhofer Institute for Solar Energy Systems, Germany
Simon Winiger	Fraunhofer Institute for Solar Energy Systems, Germany
Ezilda Costanzo	ENEA, Italy
Giorgio Pansa	POLITECNICO DI MILANO – Department ABC, Italy
Tiziana Poli	POLITECNICO DI MILANO – Department ABC, Italy
Mads Mysen	SINTEF Building and Infrastructure, Norway
Anna Svensson	SINTEF Building and Infrastructure, Norway
Fritjof Salvesen	Asplan Viak AS – KanEnergi, Norway

Project period: March 2011 – June 2014

NOTICE:

The Solar Heating and Cooling Programme, also known as the Programme to Develop and Test Solar Heating and Cooling Systems, functions within a framework created by the International Energy Agency (IEA). Views, findings and publications of the Solar Heating and Cooling Programme do not necessarily represent the views of the IEA Secretariat or of all its individual member countries.

Content

Content	5
1 Introduction and Motivation	9
2 Objectives	10
3 Methodology Approach	11
3.1 Concept of monitoring and data evaluation	11
3.2 Discussion of Primary energy and Electricity Mix in Europe	12
3.3 Evaluation of Thermal Comfort	18
3.4 Methodology of lighting evaluation.....	21
3.5 Methodology of Holistic Comparison	25
4 Documentation of Demonstration Buildings	27
4.1 School Schwanenstadt, Austria	29
4.2 Administration building - financial administration, Bruck/Mur, Austria.....	31
4.3 Administration building - court, Bruck/Mur, Austria.....	33
4.4 Kindergarten Vejtoften, Hoje Taastrup, Denmark	35
4.5 School/ Kindergarten, Ulm, Germany	37
4.6 School, Olbersdorf, Germany	39
4.7 Printing workshop & Office Building, Karlsruhe, Germany	41
4.8 Office and workshop building, Freiburg, Germany	43
4.9 School, Cottbus, Germany.....	45
4.10 Schüco Italian Headquarter, Padova, Italy	47
4.11 Solbraaveien Office Center, Asker, Norway	49
4.12 Powerhouse Kjørbo, Sandvika, Norway	51
5 Energetic Analysis	53
5.1 Analysis of delivered and primary energy.....	54
5.2 Heating Energy Analysis	56
5.3 Cooling Energy Analysis	57
5.4 Comparison of energy performance before and after the retrofit	58
5.5 Comparison of energy performance of demonstration buildings with national databases	60
6 Comfort Analysis	66
6.1 Thermal Comfort in Office Buildings.....	66
6.2 Evaluation of thermal comfort	66
7 Cross-comparison of Daylighting	73
7.1 Selection of the Case Studies	73
7.2 Results.....	74
8 Holistic comparison	83
9 Special technologies and topics studied	86
9.1 Box Type Windows.....	86
9.2 Internal thermal insulation.....	100
9.3 Model Based Predictive Control for Buildings Management Systems	111
9.4 Heat Pump systems for non-residential buildings.....	114
9.5 Prefabricated Façade	119

9.6	Daylighting technologies 124	
9.7	Dynamic analysis of the existing block of Schueco Head Office in Padova, Italy	128
9.8	Reuse of ventilation ducts.....	157
9.9	Photovoltaic panels	166
9.10	Listed Buildings	172
10	Lessons Learnt	175
10.1	Denmark	175
10.2	Germany	176
10.3	Austria	177
11	Publications.....	178
11.1	AIT:	178
11.2	Denmark:	178
11.3	Germany	178
11.4	Austria	179
12	References.....	180
Annex A	185

IEA Solar Heating and Cooling Programme

The Solar Heating and Cooling Programme was founded in 1977 as one of the first multilateral technology initiatives ("Implementing Agreements") of the International Energy Agency. Its mission is

"to enhance collective knowledge and application of solar heating and cooling through international collaboration to reach the goal set in the vision of solar thermal energy meeting 50% of low temperature heating and cooling demand by 2050.

The member countries of the Programme collaborate on projects (referred to as "Tasks") in the field of research, development, demonstration (RD&D), and test methods for solar thermal energy and solar buildings.

A total of 53 such projects have been initiated to-date, 39 of which have been completed. Research topics include:

- ▲ Solar Space Heating and Water Heating (Tasks 14, 19, 26, 44)
- ▲ Solar Cooling (Tasks 25, 38, 48, 53)
- ▲ Solar Heat or Industrial or Agricultural Processes (Tasks 29, 33, 49)
- ▲ Solar District Heating (Tasks 7, 45)
- ▲ Solar Buildings/Architecture/Urban Planning (Tasks 8, 11, 12, 13, 20, 22, 23, 28, 37, 40, 41, 47, 51, 52)
- ▲ Solar Thermal & PV (Tasks 16, 35)
- ▲ Daylighting/Lighting (Tasks 21, 31, 50)
- ▲ Materials/Components for Solar Heating and Cooling (Tasks 2, 3, 6, 10, 18, 27, 39)
- ▲ Standards, Certification, and Test Methods (Tasks 14, 24, 34, 43)
- ▲ Resource Assessment (Tasks 1, 4, 5, 9, 17, 36, 46)
- ▲ Storage of Solar Heat (Tasks 7, 32, 42)

In addition to the project work, there are special activities:

- SHC International Conference on Solar Heating and Cooling for Buildings and Industry
- Solar Heat Worldwide – annual statistics publication
- Memorandum of Understanding – working agreement with solar thermal trade organizations
- Workshops and conferences

Country Members

Australia	Germany	Singapore
Austria	France	South Africa
Belgium	Italy	Spain
China	Mexico	Sweden
Canada	Netherlands	Switzerland
Denmark	Norway	Turkey
European Commission	Portugal	United Kingdom

Sponsor Members

European Copper Institute	Gulf Organization for Research and Development
ECREEE	RCREEE

Further information:

For up to date information on the IEA SHC work, including many free publications, please visit www.iea-shc.org.

1

Introduction and Motivation

Doreen Kalz, Fraunhofer ISE

Buildings are responsible for up to 35 % of the total energy consumption in many of the IEA participating countries. The EU Parliament approved in April 2009 a recommendation that member states have to set intermediate goals for existing buildings to fix minimum percentage of buildings to be net zero energy by 2015 and 2020.

Few renovation projects have demonstrated that total primary energy consumption can be drastically reduced together with improvements of the indoor climate conditions. The experience gained from these projects has not been systematically analyzed to make it a reliable resource for planners. Because most property owners are not even aware that such savings are possible, they set energy targets too conservative. Buildings renovated to mediocre performance can be a lost opportunity for decades. It is therefore important that building owners are aware of such successes and set ambitious targets.

Furthermore, a saturated property market and high construction costs shift the focus of attention from new constructions to a successful refurbishment of non-residential buildings considering energy efficient heating and cooling. It will be a great challenge to refurbish the building stock with inexpensive, highly-energy efficient and easily implementable measures. However, technological opportunities are more limited for the existing building stock, and the implementation rate depends on the replacement cycle for building equipment and components.

Due to high investment costs, most present building renovations address single building parts as roofs, facades or heating systems only. This often results in poorly coordinated and thus inefficient and finally expensive solutions, without an appropriate long-term reduction of energy demands. Optimal results, especially with the aim of energy neutral buildings as claimed by the European Parliament from 2019 on, cannot be achieved by single renovation measures only.

Sustainable and environmentally responsible retrofit concepts for non-residential buildings

- guarantee enhanced visual, acoustic and thermal comfort and therefore provide a high-quality workplace environment, which improves the occupant's productivity and reduces the impact of the built environment on the occupant's health.
- harness the building's architecture and physics in order to considerably reduce the annual heating and cooling demand (building envelope, day lighting concept, natural ventilation, passive heating and cooling technologies).
- put emphasis on a highly energy-efficient heating and cooling plant with a significantly reduced auxiliary energy use for the generation, distribution and delivery of heating and cooling energy. The applied components and technologies are soundly orchestrated by optimized operation and control strategies.
- use less-valuable primary energy, e.g., renewable energy from environmental heat sources and sinks, solar power, biomass, etc.

2 Objectives

Doreen Kalz, Fraunhofer ISE

The objectives of IEA SHC Task 47 are to develop a solid knowledge base on how to renovate non-residential buildings towards the NZEB standards (Net-Zero Energy Buildings) in a sustainable and cost-efficient way and to identify the most important market and policy issues as well as marketing strategies for such renovations.

The objectives of **subtask C** are the development of guidelines for planners for optimized packages of measures to achieve substantial reductions in primary energy use by reducing the delivered energy demand and increasing renewable energy use. Furthermore, the energetically, economic and environmental effectiveness and impact of the measures, new components and systems as an integrated part of the renovation packages are to be quantified. As the integration of components and subsystems into heating and cooling concepts and their interaction and optimization is a challenging task. However, it offers immense opportunities for energy savings. Therefore, the description and evaluation of the integration is of major interest for planners and building operators. In this context potentials for energy savings due to smart controls in highly insulated buildings are identified and quantified.

Recommendations are derived from demonstration projects and the lessons learnt during the execution of the projects in the planning and construction phase, but also during operation.

The objectives of subtask C are the following:

- Describe the HVAC and control systems of the recommended retrofit concept. This includes information about the building shell, the HVAC system, the daylighting and artificial lighting concepts as well as available measurement or energy consumption data.
- Identify required measuring points for a basic monitoring of building and HVAC system.
- Develop a methodology for evaluating the different building and plant concepts.
- Identify and develop successful NZEB concepts considering the building envelope as well as the heating, cooling, ventilation and lighting concept.
- Evaluate the building and plant performance based on detailed energy monitoring or monthly energy bills (if measurements are made available by participants).
- Cross-comparison of the energy and efficiency performance of the buildings and heating/cooling systems.
- Describe and analyze promising components and systems that can be integrated and applied in retrofit projects. Examples are given by various demonstration projects.
- Analyze the fault detection and identify optimization potential due to smart building and plant control.
- Summary of recommendations are derived from the demonstration projects and the lessons learnt during the execution of the projects in the design and construction phase, as well as during the operation of the buildings.

3 Methodology Approach

3.1 Concept of monitoring and data evaluation

Doreen Kalz, Fraunhofer ISE

With respect to the premise of the research objectives, the scientific teams carried out a comprehensive long-term monitoring over the course of one year of operation in high time resolution (15-minutes to hourly values) with an accompanying examination of the building performance. Data were recorded by building automation systems or by a stand-alone acquisition system.

Thermal Comfort

Measurements in terms of thermal comfort comprise the dry bulb temperature, the operative room temperature (ORT), and local climatic site conditions. In some buildings, ceiling and floor surface temperatures as well as air quality were monitored (see chapter 4). Further, the heating and cooling energy consumption and the delivered energy use for heating, cooling, ventilation, and lighting were monitored. Obtained raw data are processed for data evaluation using a sophisticated method to remove errors and outliers from the database. Further, post-occupancy evaluations in terms of thermal, acoustic and visual comfort were carried out in some buildings during two successive summer and winter periods (see chapter 4).

The measurement instrumentation used for evaluating thermal comfort and its location within the rooms should comply with the recommendations given in EN ISO 7726:2002–04 (2002). Measurements are to be made where occupants are known to spend most of their time and under representative weather conditions of warm/cold seasons, advantageously at or above average outside temperatures during three warm months/cold months. The monitoring period for all measured parameters should be long enough to be representative. This depends on the time constant of the building and the prevailing weather conditions. Nowadays, the building management system usually provides data for operative room temperature, relative air humidity, ambient air temperature, and plant-specific parameters (temperatures of supply system, operation time, ventilation rates, etc.). In new buildings, wall-mounted temperature sensors encapsulated in a ventilated enclosure are often available in all office rooms. Usually, these measurements can be taken as operative temperatures with adequate accuracy, as comparative measurements in the field have shown. Special care has only to be taken of large warm and cold surfaces. If no data are available, short-term monitoring with mobile measuring devices can be carried out for several weeks in summer/winter.

Energy Performance

Energy data had been collected from monthly or quarterly invoices as well as manual and site meter readings. The energy consumption measured is divided in useful and delivered energy consumption. The primary energy consumption is calculated from the delivered energy with country or, if applicable, city specific primary energy factors. The values presented in chapter 5 are based on monitoring and simulation (design) results. If available, the energy consumption is presented separately for the different consumers considering heating, cooling, lighting, ventilation and plug loads. In chapter 5, the annual energy data is compared and plotted. Furthermore, the achieved savings in energy consumption is plotted as well. For the comparability of the energy consumption of the different buildings only the specific energy consumption in kWh/(m²*a) is analyzed and plotted. All results are compared to national standards and minimum requirements.

3.2 Discussion of Primary energy and Electricity Mix in Europe

Fritjof Salvesen, Asplan Viak AS – KanEnergi
 Jørgen Rose, AAU
 Kirsten Engelund Thomsen, AAU
 Benjamin Köhler, Fraunhofer ISE
 Ezilda Costanzo, ENEA
 Giorgio Pansa, POLITECNICO DI MILANO
 Tiziana Poli, POLITECNICO DI MILANO
 Claudia Dankl, ÖGUT

3.2.1 Norway

In Norway technical legislations sets requirements to net energy demand in buildings. It is also a requirement that the energy source used for heating and cooling have to be more renewable energy, by 60 % or more. Electricity does not count as renewable energy in this context. When energy labelling buildings, delivered energy is used.

In Norway, there are no official primary energy factors. It is difficult to compare the primary energy factors prepared in central- Europe to Norwegian conditions, because of the different energy situations. The power system in Norway mainly consists of electricity from hydropower, which has a low primary energy factor compared to electricity produced from thermal processes. There is an ongoing discussion on how to calculate primary energy factors in Norway due to the high level of electricity production of renewable resources.

A report made for Energy Norway has evaluated different methods for calculating primary energy for electricity in Norway. The report concludes that the methodology for calculation of primary energy factors used in other European countries (EU regulation) is difficult to transfer directly to Norwegian conditions, because of the high level of renewable energy production based on hydropower (app. 99%). In addition, the methodology is not consistent and transparent enough, and it is possible to influence the results based on own motivation and goals, for instance based on the interest of the hydropower industry and/or the district heating industry. This makes it difficult to unite on a joint method to be used in Norwegian regulations. The report concludes that existing policy instruments aimed at renewable energy production and fossil energy production should be preferred and developed further, and that primary energy factors would not be preferable in the Norwegian regulations.

A report made for Norsk Fjernvarme (Norwegian District heating association) has used the EN: 15603-2008 in a report to calculate common emission factors for Norwegian district heating. The calculation for electricity uses Nordic electricity mix. This is developed from the ENTSO-E statistics for the years 2004-2008.

Table 1: Primary energy factors for electricity from the two reports:

Partly substitution model (Energy Norway)	2.78
Physical energy content model (Energy Norway)	1.19
NS-EN 15603:2008 Resource (Norwegian mix) (Energy Norway)	0.6
NS-EN 15603:2008 Total (Norwegian mix) (Energy Norway)	1.54
NS-EN 15603:2008 Total (Nordic mix) (Norsk Fjernvarme)	1.79

3.2.2 Denmark

The existing Danish Building Regulations 2010 (BR10) sets the minimum energy requirements for all types of new buildings. These requirements relate to the energy frame and the envelope of the building. In addition to the minimum requirements, BR10 also sets the requirements for two voluntary low-energy classes: Low-energy Class 2015 and Building Class 2020. These two classes are expected to be introduced as the minimum requirements by 2015 and 2020, respectively. The energy performance requirements for new buildings in 2020 corresponds to the Danish nearly zero-energy building (NZEB) definition.

The energy frame is the maximum allowed primary energy demand for a building, including e.g. thermal bridges, solar gains, ventilation, heat recovery, cooling, lighting (non-residential buildings only), boiler and heat pump efficiency, electricity for operating the building, and sanctions for overheating. The overheating sanction is calculated as a fictitious energy use, equal to the energy needed for a mechanical cooling system in order to keep the indoor temperature at 26°C maximum. This additional energy use is included in the calculated overall energy consumption of the building.

The calculation procedure in the BR10 has been updated according to the new requirements, and is described in the SBi Direction 213: Energy demand in buildings (In Danish at: www.anvisninger.dk - requires license for download). The procedure follows the relevant CEN standards to great extent. This publication also includes the updated PC calculation program Be10. The calculation core of this program is to be used by all other programs for compliance checks and energy certification, to ensure the identical calculation of the energy performance of buildings.

The following primary factors are used in the calculation of the primary energy demand in the current Building Regulations and for the two voluntary low-energy classes.

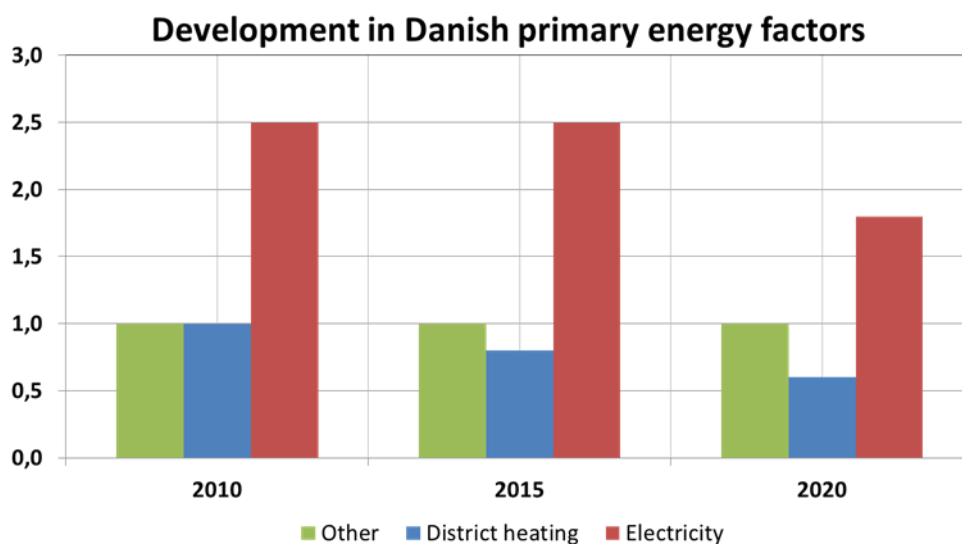

Figure 1: Primary energy conversion factors being used in the energy calculation.

The energy performance requirements for new buildings are tightened by approximately 25% in the Danish Building Regulations 2010 (BR10) compared to the old regulations. The next regulations are also tightened by approximately 25% for each step. Approximately half of the 25% tightening comes from improving the thermal envelope and the technical systems the other half from lowering the primary energy factors.

A new building - constructed today - that comply with the current or 2015 or 2020 energy performance requirements use the primary energy factors valid for the energy performance level (2010, 2015 or 2020).

There is no specific target for the share of renewable energy sources (RES) in Danish NZEB. In buildings with a large consumption of DHW (+2000 litres/day) placed outside of district heating areas a solar heating system is required (valid for both current and NZEB requirements). In 2020, it is expected that the Danish energy mix will contain a minimum of 51% RES. Primary energy factors as seen in the table and in the figure will change accordingly to this. RES production on the buildings will add to the total RES share.

The ratio between district heating and electricity (heat pumps) are almost the same in 2015 and 2020. A future increase in the COP will favour heat pumps for district heating.

3.2.3 Germany

According to the German building regulation [9] the primary energy factors listed in the standard DIN V 18599-1:2011-12 [11] have to be used for calculating the primary energy demand of buildings. The primary energy factors listed in [11] include:

- All upstream chains, inclusively material input and auxiliary energy for exploitation, processing and transportation;
- System/ balance boundary is the building envelope;
- The primary energy factors are related to the net calorific value and can only be used for the evaluation of delivered energy quantities determined related to the net calorific value;
- An up-dating, especially of the primary energy factor for electricity due to changes in the electricity mix, is possible using e.g. the datasets in GEMIS¹.

In Table 2 the primary energy factors for the main energy carriers according to [11] are listed, both for the total energy amount and the non-renewable share.

Table 2: Primary energy factors according to [11] of different energy carriers in Germany.

Energy carrier ^a		Primary energy factor f_p	
		total	Non-renewable share
		A	B
Fossil fuels	Heating oil EL	1.1	1.1
	Natural gas H	1.1	1.1
	Liquefied natural gas	1.1	1.1
	Hard coal	1.1	1.1
	Lignite	1.2	1.2
Biogenic combustibles	Biogas	1.5	0.5
	Bio petroleum	1.5	0.5

¹ See <http://www.iinas.org/gemis-de.html>

	Wood	1.2	0.2
District heat from CHP ^b	Fossil fuels	0.7	0.7
	Biogenic combustibles	0.7	0.0
District heat from heating station	Fossil fuels	1.3	1.3
	Biogenic combustibles	1.3	0.1
Electricity	General electricity mix	2.8	2.4 ^c
	Displacement electricity mix	2.8	2.8
Environmental energy	Solar energy	1.0	0.0
	Ground heat/ geothermal energy	1.0	0.0
	Ambient heat	1.0	0.0
	Ambient cold	1.0	0.0
Waste heat inside the building	From processes	1.0	0.0

a: scale basis delivered energy: net calorific value H_i .

b: Values are typical for district heating networks with a CHP-share of 70%.

c: The primary energy factor in the German building regulation will be changed to 1.8 for electricity produced by CHP-plants in residential buildings on 1st January 2016 due the rising share of renewable energies.

3.2.4 Italy

The energy performance of a building, in terms of Primary Energy, is calculated according to the following formula:

$$Q_{P,nren,gl} = \sum_k (Q_{P,nren,k}) = Q_{P,nren,H} + Q_{P,nren,C} + Q_{P,nren,W} + Q_{P,nren,V} + Q_{P,nren,L}$$

$Q_{p,nren,gl}$ is the global non-renewable primary energy

$Q_{p,nren,gl,k}$ is the global non-renewable primary energy related to the k-energy services (H = heating; C = cooling; W = hot water; V = ventilation; L = lighting)

The primary energy is calculated, for each energy services (k), considering both the delivered energy and the exported energy, with reference to each energy carrier (i).

$$Q_p = \sum_i \dot{Q}_{del,i} \times f_{p,del,i} - \sum_i \dot{Q}_{exp,i} \times f_{p,exp,i}$$

The conversion factors (f_p) are specified in the following Table, distinguishing in non-renewable primary energy factor ($f_{p,nren}$) and renewable energy factors ($f_{p,ren}$). Although the definition mentioned in the UNI EN 15603, these factors don't include the energy

used for processing, storage, generation, transmission, distribution, and any other operations necessary for delivery to the building in which the delivered energy is used.

Table 3: Primary energy factors (source [1])

Energy carrier	$f_{p,ren}$	$f_{p,ren}$	f_p
Gas	1	0	1
GPL	1	0	1
Fuel oil	1	0	1
Biomass (solid, liquid and aeriform)	0.3	0.7	1
Electricity from the grid*	2.174	0	2.174
District heat	**	-	-
Solar	0	1	1

* Delibera EEN 3/08 – AEEG (the conversion factor of kWh in tep is equal to 0.187×10^{-3} tep/kWh)

** Declared value from the supplier

3.2.5 Austria

In Austria primary energy factors are defined in the 'OIB Guideline 6' on 'Energy saving and heat insulation', a guideline from the OIB – Österreichisches Institut für Bautechnik / Austrian Institute of Construction Engineering, last revision from October 2011. The OIB guidelines serve to harmonize the construction engineering regulations across all of Austria. They are issued by the OIB and adopted by the Austrian federal states into their Construction Laws.

Following chapter 6 in the OIB Guideline 6 the primary energy demand has to be specified for gross floor area (Bruttogrundfläche BGF) and with reference to the local climate (Standortklima): $PE_{BGF,SK}$. The calculation has to be carried out following the OIB Guideline under application of the conversion factors. For non-residential buildings the electricity demand for the operation has to be considered following the point 5 of the Guideline: For building categories 1 to 12 50% of the mean value from $q_{i,h}$ (inner heat gains due to persons and appliances while heating) or $q_{i,c}$ (inner heat gains due to persons and appliances when cooling) has to be considered.

Table 4: Primary energy factors (source [1])

Energy carrier	f_{PE} [-]	$f_{PE,ren}$ [-]	$F_{PE,ren}$ [-]	f_{CO_2} [g/kWh]
Coal	1.46	1.46	0.00	337
Fuel oil	1.23	1.23	0.00	311
Natural gas	1.17	1.17	0.00	236
Biomass	1.08	0.06	1.02	4
Electricity (Austrian mix)	2.62	2.15	0.47	417
District heat from heating station (renewable)	1.60	0.28	1.32	51

District heat from heating station (non-renewable)	1.52	1.38	0.14	291
District heat from CPH* (default values)	0.92	0.20	0.72	73
District heat from CPH* (best values)	> 0.3	Declared value from supplier **		
Waste heat (default value)	1.00	1.00	0.00	20
Waste heat (best value)	> 0.3	Declared value from supplier		

* Highly efficient combined heat and power plants are those corresponding to EU directive 2004/8/EG

** In case that values are declared from the supplier corresponding to EN 15316-4-5, no smaller values shall be taken than those for waste heat (best value). Conditions for calculation are taken down in an additional document (Erläuternde Bemerkungen).

3.3 Evaluation of Thermal Comfort

Doreen Kalz, Fraunhofer ISE

3.3.1 Criteria for Thermal Comfort

Different physical parameters affect physiological reactions to the environment. Thus, these parameters (air, radiant and surface temperature, air velocity and humidity) are also the basis for defining criteria for an acceptable thermal environment. The criteria result in requirements for general thermal comfort (PMV/PPD index or operative temperature) and for local comfort disturbance (i.e. draft, radiant asymmetry, vertical air temperature differences and requirements on surface-temperature differences). They can be found in international standards and guidelines such as EN ISO 7730:2005 [8], CR 1752 [5], EN 15251:2007-08 [7], and ASHRAE 55:2004-04 [3], or in their national derivative respectively.

3.3.2 Standards on Thermal Comfort

There are two main models to determine human thermal comfort and to predict the occupant's satisfaction with the interior conditions: (i) the **heat-balance approach** used in the standard EN ISO 7730:2005 and (ii) the **adaptive approach** described in the standards EN 15251:2007-08, ASHRAE 55:2004, and the Dutch guideline ISSO 74:2005 (Boestra et al. 2005).

PMV Approach to Thermal Comfort

The PMV approach to thermal comfort (EN ISO 7730:2005) is derived from the physics of heat transfer and combined with an empirical fit to sensation (predicted mean vote and predicted percentage of dissatisfaction) (Fanger 1970). The required four environmental input variables are air and mean radiant temperature, air speed, and humidity. The two personal variables are clothing and metabolic heat production. The predicted mean vote PMV is the thermal comfort index probably most widely used for assessing moderate thermal indoor environments. It rests on the steady state heat transfer theory, obtained during a series of studies in climatic chambers, where the climate was held constant. It predicts the expected comfort vote of occupants on the ASHRAE scale of subjective warmth (-3 cold to +3 hot) as well as the predicted percentage of dissatisfaction (PPD) for a certain indoor condition.

Thermal comfort requirements in **DIN ISO 7730** rest upon the heat-balance approach (Fanger 1970) and are distinguished into a summer and a winter season. The ranges of temperature which occupants of buildings will find comfortable are merely influenced by the characteristic heat insulation of clothing. Therefore, the defined comfort criteria are generally applicable for all rooms, independent of the building technology for heating, cooling, and ventilation:

$$\theta_{o,c} = 24.5^{\circ}\text{C} \text{ for summer season}$$

$$\theta_{o,c} = 22.0^{\circ}\text{C} \text{ for winter season}$$

The criterion for thermal comfort is stipulated as an average operative room temperature of 24.5°C for the summer and 22°C for the winter period, with a tolerance range depending on the predicted percentage of dissatisfied occupants: $\pm 1.0^{\circ}\text{C}$, $\pm 1.5^{\circ}\text{C}$, and $\pm 2.5^{\circ}\text{C}$ (classes I, II, and III).

The **German Annex to EN 15251** defines two comfort ranges for the summer period with reference to the maximum daily ambient air temperature—i.e., below or above a maximum temperature value of 32°C:

$$\theta_{o,c} = 22^{\circ}\text{C} \text{ for } \theta_{e,d,max} \leq 16^{\circ}\text{C}$$

$$\theta_{o,c} = 22^{\circ}\text{C} + 0.25 \cdot (\theta_{e,d,max} - 16^{\circ}\text{C}) \text{ for } 16^{\circ}\text{C} < \theta_{e,d,max} \leq 32^{\circ}\text{C}$$

$$\theta_{o,c} = 26^{\circ}\text{C} \text{ for } \theta_{e,d,max} > 32^{\circ}\text{C}$$

Though the German national annex allows for categories I to IV, it defines only category II for new and retrofitted office buildings, with a tolerance band of $\pm 2\text{K}$. Diverging from EN 15251, no exceedance of this tolerance band is allowed.

Adaptive Approach to Thermal Comfort

The adaptive comfort model considers the thermal sensation of the occupants and different actions in order to adapt to the (changing) thermal environment (e.g., change of clothes, opening windows) as well as variable expectations with respect to outdoor and indoor climate, striving for a “customary” temperature. The underlying assumption is that people are able to act as “meters” of their environment and that perceived discomfort is a trigger for behavioral responses to the thermal environment. Although these phenomena cannot yet be described theoretically in full detail, a model was derived from results of field studies, representing limits to the operative temperature as a function of the outdoor temperature. This simplified approach also avoids difficulties occurring with the assumption of appropriate *clo* and *met* values, as has to be done with the PMV approach. They are included in the resulting accepted temperature as part of the adaptation.

EN 15251 evaluates the operative room temperature in relation to the running mean of the ambient air temperature. Again, the temperature range defining thermal comfort in summer correlates with user satisfaction: $\pm 2.0^{\circ}\text{C}$, $\pm 3.0^{\circ}\text{C}$ and $\pm 4.0^{\circ}\text{C}$ (classes I, II, and III). The different ranges refer to the categories defined in the standard (category I: less than 6% dissatisfied, category II: less than 10% dissatisfied, category III: less than 15% dissatisfied, category IV: more than 15% dissatisfied—based on occupants’ expectations on indoor climate):

$$\theta_{o,c} = 18.8^{\circ}\text{C} + 0.33 \cdot \theta_{rm} \text{ for summer season}$$

The outdoor temperature has to be calculated as a weighted running mean value, referring to the idea that most recent experiences (last one to seven days) might be more important for the “thermal memory”. The running mean ambient air temperature θ_{rm} is given as a function of the one at the previous days θ_{rm-1} and the daily mean ambient air temperature of the previous days $\theta_{e,d-1}$ with $\alpha=0.8$.

$$\theta_{rm} = (1 - \alpha) \cdot \theta_{e,d-1} + \alpha \cdot \theta_{rm-1}$$

3.3.3 Comfort Analysis of the demonstration buildings

Thermal comfort in office buildings is evaluated in accordance with two models defined in the European standard EN 15251:2007-08: the PMV and the adaptive comfort model. In accordance with the defined comfort standard, a standardized evaluation for measurement campaigns is presented in order to evaluate thermal comfort in summer in office buildings under real operation.

The evaluation methodology comprises the following items:

Thermal-Comfort Standards. The following categories are proposed for the evaluation of thermal comfort in summer:

- Adaptive comfort approach for low-energy buildings with passive or without cooling: Again, the development of interior thermal comfort depends strongly on the behaviour of the occupants and their use of the rooms, e.g., operation of windows, doors, and solar-shading system, the technical equipment of the rooms, the presence of occupants, and use of the rooms as open-plan or single office. Thermal comfort is evaluated in accordance with the adaptive approach of EN 15251:2007-08.
- Adaptive comfort approach for low-energy buildings with air-based mechanical cooling: In these buildings, the level of adaptation and expectation is strongly related to outdoor climatic conditions. The application of an adaptive comfort model for the evaluation of thermal comfort in office buildings with free or mechanical night-ventilation is suitable. Occupants tolerate higher room temperatures at higher ambient air temperatures. The analysis of a field survey (see chapter 5) and the resulting comfort temperature confirm the adaptive comfort model of EN 15251:2007-08 for buildings with night-ventilation.
- PMV-PPD comfort approach for low-energy buildings with water-based mechanical cooling: Although users seem to adapt to the prevailing outdoor climate conditions, they expect a cooled interior environment and, therefore, have higher expectations on the interior thermal comfort. A field study revealed that users in these buildings tolerate only slightly higher room temperatures than the defined temperature set points in EN 15251 (see chapter 5). Therefore, thermal comfort should be evaluated in accordance with the PMV model.

Thermal-Comfort Assessment: Thermal comfort assessments are determined separately for the summer and winter seasons in accordance with the comfort approaches of the European standard EN 15251:2007-08. Evaluated are the numbers of hours during occupancy whenever the operative room temperatures exceed the defined upper and lower comfort limits of classes I, II, and III. Comfort ratings are analyzed in hours of exceedance during the time of occupancy.

User Behavior: The allocation of the buildings to comfort classes is based entirely on long-term measurements. For that reason, user behavior (in terms of opening windows and using solar shading as well as their working activity and clothing level) is not being recorded.

Time of Occupancy: Thermal comfort is evaluated only during the time of occupancy, e.g., on weekdays from 8 a.m. to 7 p.m. statutory holidays (e.g., Christmas, Easter) are considered, but not summer/winter vacation periods.

Building Area: Thermal comfort evaluation of a building under operation is carried out for at least 84% (standard deviation) of the building area. However, during the design stage of the building and the technical plant, 95% of the building area are required to meet the comfort class, based on the assumption of standardized occupant behavior.

Range of tolerance for comfort evaluation: As recommended by EN 15251:2007-08, measured values of the operative room temperature during occupancy are allowed to be outside the defined comfort boundaries I to III during a maximum of 5% of the working time in summer season. In other words, during 95 to 97% of the occupancy time, the required thermal conditions are met.

Building Classification: In accordance with the comfort criteria, the buildings are assigned to a comfort class I, II, or III, indicating the percentage of satisfied occupants. The requirement for a certain comfort class is fulfilled if at least 84% of the recorded hourly temperature measurements remain within the defined comfort limit and its equivalent tolerance range. Comfort class II represents a “normal level of expectation and should be used for new buildings and renovations” (EN 15251).

Thermal Comfort Footprint: Comfort results for a building with its energy concept for heating, cooling, and ventilation are presented as thermal comfort footprint (s. Figure 2), indicating the time of occupancy when thermal interior comfort complies with classes I to III. The period is given as a percentage of the total occupancy during summer. This fosters the comparison of the annual energy demand/consumption for heating and cooling with the simulated/monitored thermal comfort.

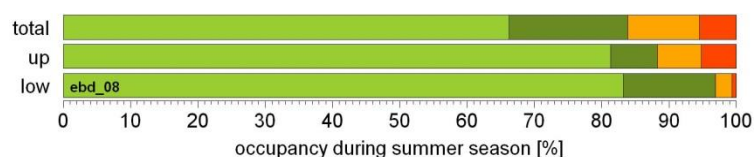

Figure 2: Exemplary thermal comfort footprint (demonstration building GER03).

Presentation of Thermal-Comfort Results: As the “footprint” characterizes the building in a general matter, clients and building operators may not be able to understand the conclusion, especially the relevance of room temperatures exceeding the upper comfort limit in winter and the lower limit in summer. Therefore, we recommend to clearly state that the comfort diagram should be shown in addition to the footprint. Despite the building’s categorization, the results of the thermal-comfort assessment should be presented for both the adaptive and the PMV-comfort approach. This will provide the client with data for the expected performance of the entire building concept.

3.4 Methodology of lighting evaluation

Roman Jakobiak, Daylighting

IEA Task 47 deals with the renovation of non-residential buildings to a high level of energy efficiency. Subtask A is about Case Studies. This section includes a cross-analysis of the Subtask A case studies about lighting. Information on the case studies of Subtask A can be found at <http://task47.iea-shc.org/publications>.

3.4.1 Metrics used to analyze the case studies

In contrast to a monitoring project no project-related measurement campaign was carried out in IEA Task 47. Instead, projects were provided by the participants, which previously were studied independently of the IEA-Task at the national level. The case studies were therefore different with respect to available data. There was thus no homogeneous data base on the different case studies.

The description of lighting quality can refer to different aspects of the luminous environment. For example the illuminance level, the directivity of light, color rendering or glare are different areas of lighting quality. The evaluation of daylight is difficult because of the ever changing nature of daylight. Diurnal as well as seasonal variations as well as changing sky conditions need to be considered. The lighting situation can be evaluated as a whole or focus on specific system components. A holistic evaluation of a daylighting solution therefore is time consuming and requires appropriate monitoring equipment.

The cross-sectional analysis in Task 47 had to use the information that already had been filed. Although the experience of a space to be evaluated is capital in order to assess lighting quality, measurements or even just a building visit was not performed as part of Task 47. In this situation the scheme of assessment had to be derived from the available information.

3.4.1.1 Daylighting

The renovation of the facade affects both the thermal envelope consisting of walls and windows as well as operable daylighting system to prevent from overheating and to protect from glare. A holistic assessment of the facade therefore should consider the static building envelope as well as the changing daylighting systems. Suitable metrics for this purpose are the relative period of use and the relative covering of daylight in providing the required indoor lighting. This second metric corresponds to the daylighting supply factor according to DIN V 18599-4 [16]. The relative period of use corresponds to the fraction of working time when the daylight illuminance reaches or exceeds the target illuminance. In both cases daylighting systems are considered in their actual behavior. These metrics which are defined in DIN 5034-3 [15] were, for example, determined by measurement in the research project about the renovation of the Friedrich Froebel special school in Olbersdorf [17]. In order to measure the daylight supply factor and the relative period of use the illuminance needs to be recorded continuously, these measurements therefore require a high level of effort. In practice, these metrics therefore are rarely measured. The use of the daylight supply factor and the relative period of use for the cross-analysis in Task 47 was not possible anyway, since these metrics had not been determined in the case study projects.

In the case studies of Task 47, lighting is typically only a side aspect of energy-efficiency. The main focus is in most cases on the building envelope and the systems for heating, air conditioning and ventilation. For the windows, geometric and physical information in most cases was part of the case study presentation. The shading and glare protection systems have been characterized, however, usually grossly only in qualitative terms. The case study descriptions hence were lacking of essential information regarding these systems. The available information allowed describing the technical properties of the window and the interior space before and after renovation. With this information a statement about the general daylighting level before and after renovation could be correlated. Thus, the effect of the renovation of the daylight level could be evaluated. However, a statement about the performance of the daylighting systems which in most cases had been renovated as well was not possible.

The analysis should on the one hand allow a relative comparison of the solution before and after renovation and on the other hand enable an absolute estimate of the daylighting levels. The impact of each renovation measures on daylighting should be shown.

To compare the situation before and after renovation the metric *effective window area* was used. The *effective window area* was related to the floor area of the space. This results in a better comparison between projects. The determination of the effective window area is shown in Annex B: Calculation Methodology for the *effective window area*.

The specific effective window area is not a new metric. It previously was used in other projects. For example in the cross-analysis of the SolarBau:monitor program the ratio of the effective size of the aperture to the floor area was used [18].

For a qualitative statement about the daylight level the daylight factor is used. The daylight factor is by far the most widespread parameter for characterizing daylight in buildings. The daylight factor takes into account the transparency of window systems, the window location, the room proportions, the reflectances of room surfaces and ob-

structions. It enables to characterize the daylight potential in a space referring to a static sky condition.

The daylight factor ignores variable sky conditions as well as operable daylighting systems. Therefore, the daylight factor cannot describe the real performance in a space, but it allows a correlation with the daylight supply factor. The calculation of the daylight factor is described in [15].

In contrast to the component-related metric of the effective window size the daylight factor refers to the space as a whole, but it needs to be determined for a specific position in the space. In this project the daylight factor has been calculated for the center of the space at a height of 0.85 m above the floor. As an indicator for adequate daylighting the German standard DIN 5034-1 [14] recommends for this location a daylight factor of at least 2%.

3.4.1.2 Electric lighting

The electric lighting energy consumption is in an important result in a renovation project focusing on energy efficiency. However, monitoring results on the electric lighting energy use were not available in most of the case studies. The possibility of calculating the energy use of the lighting system was discarded, because in different countries different calculation methods and boundary conditions are applied. The results would therefore be either not comparable or would not match with the calculations done according to national standards. Secondly, results based on real monitoring data are convincing, while results deducted from calculations are arguable.

In order to evaluate electric lighting the specific installed power density before and after renovation was determined. This metric relates to the energy performance of the electric lighting system but does not take into account the efficiency of control systems. Since daylight and occupancy responsive controls are not considered in the specific installed power density this metric is not an indicator for the electric energy consumption of lighting, it just indicates the efficiency of the generation of electric light. Since the specific installed power density can be determined without considering country-specific conditions, it can easily be used for the cross analysis.

3.4.2 Method

To assess the daylighting strategy a typical room was selected to be evaluated in the building. The selection of a representative space was made regarding the use of the space, the dimensions of the space, the orientation of the façade and the equipment with windows and daylighting systems. The selected space should in no way be a special case. Another criterion was that the dimensions of the selected space were not considerably changed in renovation. Only the selected spaces were evaluated. Strictly speaking, the result is thus valid only for this single space. However, as a representative space has been evaluated, it can be assumed that the result of the evaluation is representative for the building.

For the selected space lighting-related parameters were recorded and filled in a form. See Table 5. Only a part of this information was needed to generate the metrics used for evaluation (see section 3.4.1 *Metrics used to analyze the case studies*). The other data as well as the photographs and drawings make it possible to get an impression of the case study, but are not used for a quantitative evaluation.

Table 5: List of lighting-related parameters that have been included in the survey format.

Space	Light transmission of glazing
Use of reference space	Color rendering index of glazing [Ra]
Design illuminance level of electric lighting [lx]	g-Value of glazing
Room number	g-total (window + shading)
Floor	U-Value of window [W/(m ² K)]
Characteristic room width [m]	U-Value of glazing [W/(m ² K)]
Characteristic room depth [m]	Daylighting system
Floor to ceiling height [m]	Type
Floor, material	Function
Floor, color	Location
Floor, reflectance	Adjustability
Wall, material	Control
Wall, color	Electric Lighting strategy
Wall, reflectance	Identification
Ceiling, material	Function
Ceiling, color	Type of mounting
Ceiling, reflectance	Luminous flux distribution
Window	Distribution in space
Orientation [°]	Type of lamp in luminaire
Thickness of window wall [m]	Type of gear
Type	Number of lamps in each luminaire
Operability	Power consumption of one lamp [W]
Obstruction	Number of rows
Parapet height [m]	Number of luminaires in each row
Height of window head [m]	Number of luminaires in space
Window width [m]	User interface
Window area [m ²]	Number of control-zones for this type of luminaire
Type of frame [type]	Occupancy responsive controls
Reduction factor for frame	Occupancy - follow up time [min]
Glazing area [m ²]	Daylight responsive controls
Type of glazing [type]	Maintenance responsive controls

When calculating the effective window size and the daylight factor missing information about boundary conditions was replaced by default values. For example, the reduction factor for frames in many cases could not be determined from the records. The use of default values does defocus the result to some extent, because not all boundary condition are directly derived from the case study. The boundary conditions of calculation are

described in Annex A: Boundary conditions of calculation. Table 41 contains a list of the default values that were used, if the relevant information was missing.

3.5 Methodology of Holistic Comparison

Doreen Kalz, Fraunhofer ISE
Benjamin Köhler, Fraunhofer ISE

Sustainable and environmentally responsible non-residential building concepts:

- Guarantee enhanced visual, acoustic, and thermal comfort and therefore provide a high-quality workplace environment, which improves the occupant's productivity and reduces the impact of the built environment on his/her health.
- Harness the building's architecture and physics in order to considerably reduce the annual heating and cooling demand (building envelope, day-lighting concept, natural ventilation, passive heating and cooling technologies).
- Put emphasis on a highly energy-efficient heating and cooling plant with a significantly reduced auxiliary energy use for the generation, distribution and delivery of heating and cooling energy. The applied components and technologies are soundly orchestrated by optimized operation and control strategies.
- Use less valuable primary energy, e.g., more renewable energy from environmental heat sources and sinks, solar power, biomass, etc.

Under this premise, a holistic approach is applied for the evaluation of heating and cooling concepts, seeking to achieve a global optimum of (1) interior thermal comfort, (2) interior humidity comfort, (3) useful cooling-energy use, and (4) the building's total primary-energy use for heating, cooling, ventilation, and lighting.

Figure 3 illustrates an individual building signature correlating cooling-energy use [$\text{kWh}_{\text{th}}/(\text{m}^2_{\text{net}}\text{a})$], the building's total primary-energy use for heating, cooling, ventilation, and lighting [$\text{kWh}_{\text{prim}}/\text{m}^2\text{a}$], and thermal and humidity comfort classifications in accordance with EN 15251:2007-08. The green diamond represents the target objective for these three parameters and the arrows indicate the direction of the optimum.

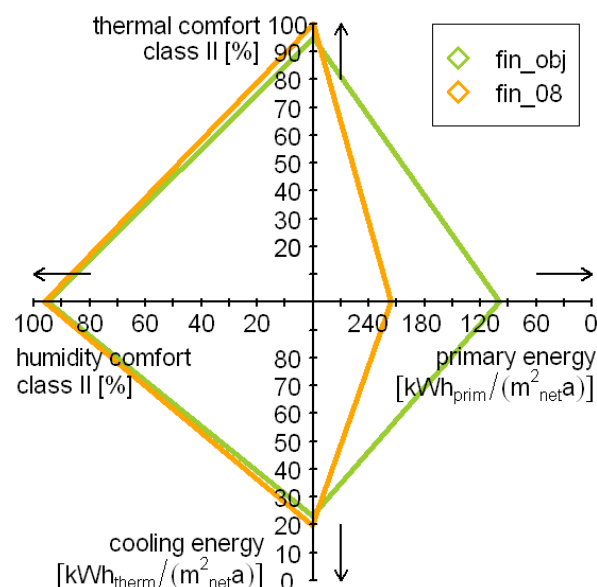

Figure 3: Building signature. This building signature shows results for a monitoring campaign and its evaluation in accordance with the guidelines. The thermal indoor environment meets the requirements of class II. The useful cooling energy meets the building-physical requirements on summer-heat protection. Only the primary-energy demand of the building is higher than the target value and does not meet the requirements

Occupant Thermal and Humidity Comfort: Occupant thermal comfort assessments of the buildings in summer are evaluated in accordance with the European EN 15251:2007-08 guideline. The building signatures present the time at the required comfort class during occupancy. Thermal comfort is evaluated with the proposed methodology in accordance with the

- adaptive-comfort approach for building concepts with passive cooling and night ventilation concepts and
- PMV-comfort approach for building concepts with water-based mechanical and mixed-mode cooling.

The target objective for the comfort class is defined during the design stage of the building. Then, thermal-comfort measurements are evaluated correspondingly. The comfort class is guaranteed if recorded temperature values remain within the required comfort class during 95% of the occupancy time.

Cooling-Energy Use: Measurements of useful cooling energy are derived from the long-term monitoring campaigns—carried out by the particular IEA task47 partners. If measurements are not available, simulation results or calculations are presented.

Heating-Energy Use: Measurements of useful heating energy are derived from the long-term monitoring campaigns—carried out by the particular IEA task47 partners. If measurements are not available, simulation results or calculations are presented.

Primary-Energy Use: The primary-energy consumption of the buildings considers the heating and cooling plant as well as ventilation and lighting. If not stated otherwise, plug loads are not included. The primary-energy approach allows for comparing concepts that use different energy sources such as fossil fuels, electricity, environmental energy, district heat, waste heat, and biomass. The primary-energy factors of the participating countries are described and listed in chapter 3.2.

4 Documentation of Demonstration Buildings

Benjamin Köhler, Fraunhofer ISE
Doreen Kalz, Fraunhofer ISE

In the following, the evaluated and monitored buildings (see Table 6) are described in tables including information about climate conditions, occupancy, year of completion and refurbishment dates, areas and energetic characteristics. Furthermore the tables contain energy schematics of each building, and the main monitoring results (if available).

Table 6: List of buildings analysed and described in detailed in following chapters.

Building and city	Country	Usage	Conditioned floor area [m²]	H/C technology after retrofit
AT01: Schwanenstadt	Austria	School	5,119	Wood pellet
AT02: Bruck/Mur	Austria	Administration building	6,486	District heating (RES), Heat pump, heat recovery
DK: Hoje Taastrup	Denmark	Kindergarten	330	District heating, heat recovery
GER01: Ulm	Germany	School/ Kindergarten	517	District heating, heat recovery
GER02: Olbersdorf	Germany	School	4,440	Gas-absorption heat pump, gas-condensing boiler (peak load)
GER03: Karlsruhe	Germany	Printing workshop and office	1,111	Waste heat, heat pump, heat recovery, back-up gas boiler
GER04: Freiburg	Germany	Workshop and office	1,490	Neighbouring building, district heat (back-up), heat recovery
GER05: Cottbus	Germany	School	9,509	District heat (CHP), heat recovery, pre-heating of air (ground heat-exchanger), solar heat
ITA: Padova	Italy	Office	1,334	Gas condensing boilers, ground-coupled heat pump, solar heat
NOR01: Asker	Norway	Office	9,365	Air/water heat pump, electric ovens
NOR02: Sandvika	Norway	Office	5,200	Ground-coupled heat pump, district heat

Each building table consists of two pages. On the first page general information about the building is given (e.g. utilisation, number of occupants, utilization time, floors, area and volume). Additionally the main characteristics of the building envelope are described and the energy supply system is schematically illustrated. Additionally, the basic parameters of the cooling and ventilation system are described. At the bottom of the first page and the top of the second page the results of the thermal comfort analysis are listed and plotted in form of a "comfort footprint" indicating the percentage of time during occupancy in which the comfort boundaries given in EN 15251:2007-08 are met and a comfort plot in the which the operative room temperatures during the monitoring period (during occupancy) are plotted in dependency to the running mean of the ambient air temperature. These plots are only illustrated if adequate monitoring data was available.

In the lower part of the second page of each building description the monitoring results of the cooling, heating, ventilation, lighting, plug loads and total building energy demand are listed on the left side. The energy demand distinguishes between useful, final and primary energy. On the right side the comfort during summer, primary energy, cooling energy and heating energy before the retrofit are compared with the respective design values in a four dimensional radar diagram.

4.1 School Schwanenstadt, Austria

Special feature: Renovation to meet Passive House Standard (AT01)

Schwanenstadt Austria (48°3', 13°47', 389m)

INFORMATION ON BUILDING AND USE

occupancy	school	
number of occupants	300	
utilization	7am-4pm	
completion	1960	
refurbishment	2007	
number of floors	3	
total floor area [m ²]	5,243	
total conditioned area [m ²]	5,119	
total volume [m ³]	17,432	
area-to-volume ratio [m ⁻¹]	-	

Source: task47.iea-shc.org/data/sites/1/publications/Schwanenstadt-Austria.pdf

BUILDING ENVELOPE

shading system	Exterior, automatic operation with manual adjustability
U-values [W/(m ² K)]	exterior wall: 0.08 window: 0.8 roof: 0.1 ground: 0.15 avg. value of building: 0.3
window	triple glazed, low-E g-value: 0.55 area: 1612m ² window-façade-ratio: 62%

CONCEPT COOLING

environmental heat sink	-
energy carrier	-
cooling system	-
power of system [kW _{therm}]	-
distribution system	-

VENTILATION CONCEPT

operable windows	yes
night-ventilation	no
mechanical ventilation	yes
air-change rate [m ³ /h ⁻¹]	100-500
pre-cooling of air	no

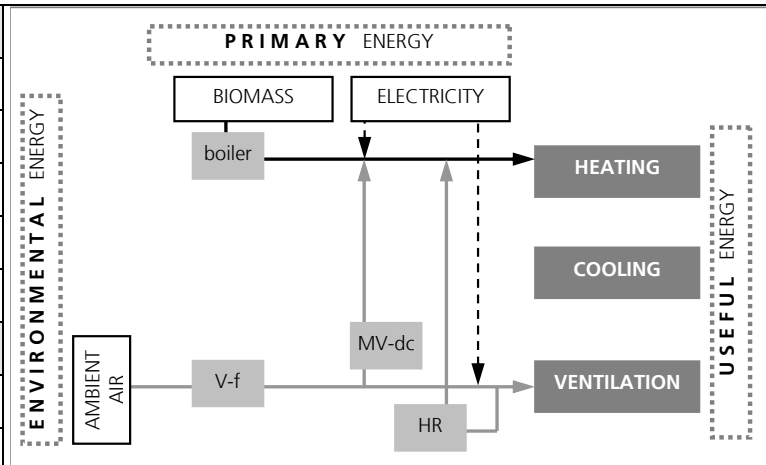

ambient air (AA) | borehole heat exchangers (BHEX) | electricity (E) | gas (G) | district heat (DH) | free (f) | ground (GR) | heat recovery (HR) | mechanical ventilation (MV) | night-ventilation (NV) | water-driven, ceiling suspended cooling panels (CP-w)

THERMAL COMFORT PERFORMANCE IN SUMMER

year(s) of monitoring	2007-09
year of evaluation	2008/09
number of rooms	4
ambient air temperature	public WS ^b
design temperature [°C]	20
adaptive, class II (up) ^c	97%
adaptive, class II (low) ^d	97%
avg. room temperature [°C] ^e	23-27
POE ^f	yes

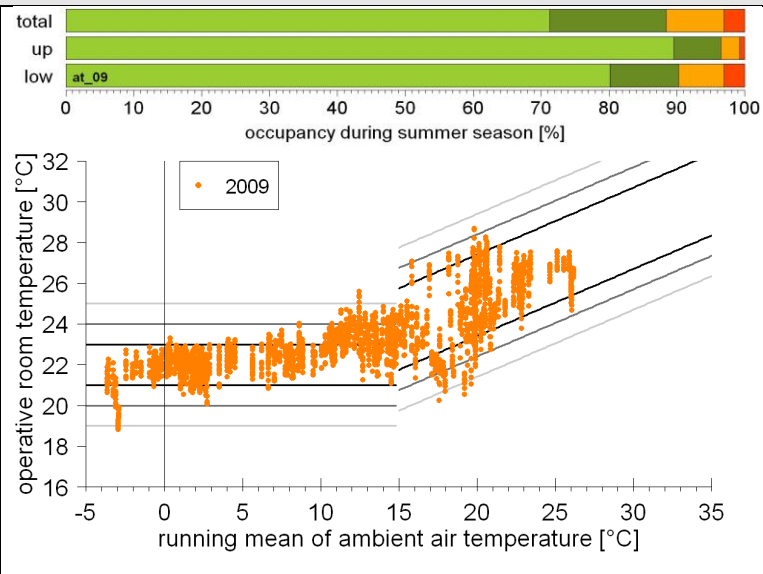

MONITORING RESULTS AND BUILDING SIGNATURE (period 6/2008 to 5/2009)

COOLING	
useful energy [kWh _{th} /m ² a]	n/a
delivered energy [kWh _{fin} /m ² a]	n/a
primary energy kWh _{prim} /m ² a]	n/a ^g
HEATING	
useful energy [kWh _{th} /m ² a]	21.89
delivered energy [kWh _{fin} /m ² a]	32.4
primary energy [kWh _{prim} /m ² a]	7.87
VENTILATION	
delivered energy [kWh _{fin} /m ² a]	1.96
primary energy [kWh _{prim} /m ² a]	5.29 ^g
LIGHTING	
delivered energy [kWh _{fin} /m ² a]	16.44
primary energy [kWh _{prim} /m ² a]	44.39 ^g
APPLIANCES/PLUG LOADS	
delivered energy [kWh _{fin} /m ² a]	n/a
TOTAL BUILDING	
delivered energy [kWh _{fin} /m ² a]	50.63
primary energy [kWh _{prim} /m ² a]	57.1
onsite generation of energy	yes

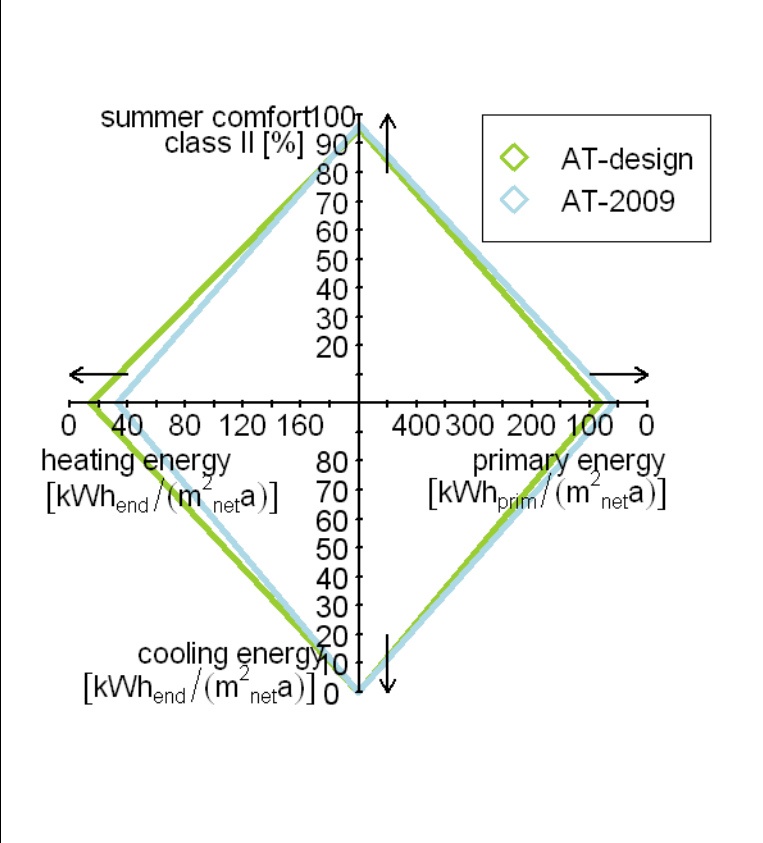

(a) open-plan office and normal offices, (b) public weather station in city, (c) upper comfort boundaries, (d) lower comfort boundaries, (e) during occupancy, (f) post-occupancy evaluation, (g) primary energy factor electricity: 2.7, (h) primary energy factor heating: biomass 0.2, district heating 0.7

4.2 Administration building - financial administration, Bruck/Mur, Austria

Special features: Special façade, innovative HVAC (incl. bivalent heat pump), lighting concept (AT02)

INFORMATION ON BUILDING AND USE

occupancy	office	
number of occupants	n/a	
utilization	7am-6pm	
completion	1964	
refurbishment	2006	
number of floors	5	
total floor area [m ²]	3,872	
total conditioned area [m ²]	3,872	
total volume [m ³]	13,027	
area-to-volume ratio [m ⁻¹]	0.28 (financial admin.) 0.33 (court)	

Source: shc.org/data/sites/1/publications/Adminbuilding_Bruck_.pdf

task47.iea-

BUILDING ENVELOPE

shading system	Integrated shutter, automatic operation with manual adjustability
U-values [W/(m ² K)]	exterior wall: 0.16 window: 0.3 roof: 0.11 avg. value of building: 0.37
window	solar control glazing g-value: 0.08 area: n/a m ² window-façade-ratio: n/a %

CONCEPT COOLING

environmental heat sink	-
energy carrier	-
cooling system	-
power of system [kW _{th}]	-
distribution system	-

VENTILATION CONCEPT

operable windows	yes
night-ventilation	-
mechanical ventilation	no
air-change rate [h ⁻¹]	3
pre-cooling of air	n/a

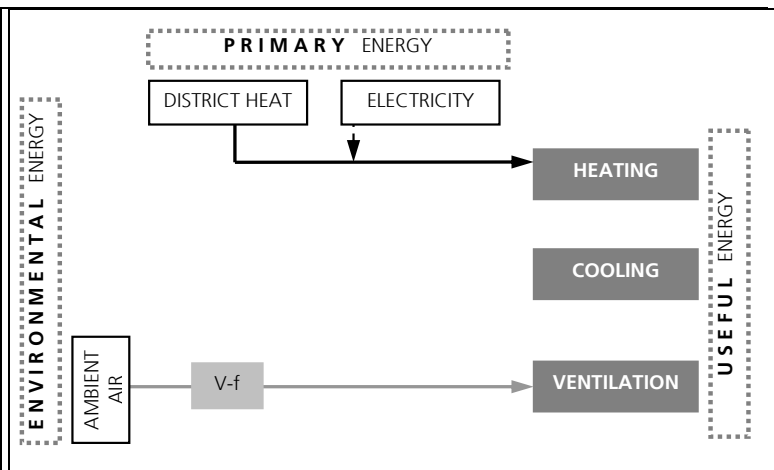

ambient air (AA) | borehole heat exchangers (BHEX) | electricity (E) | gas (G) | district heat (DH) | free (f) | ground (GR) | heat recovery (HR) | mechanical ventilation (MV) | night-ventilation (NV) | water-driven, ceiling suspended cooling panels (CP-w)

THERMAL COMFORT PERFORMANCE IN SUMMER	
year(s) of monitoring	2012-n/a
year of evaluation	n/a
number of rooms	n/a
ambient air temperature	public WS ^b
design temperature [°C]	20
adaptive, class II (up) ^c	n/a
adaptive, class II (low) ^d	n/a
avg. room temperature [°C] ^e	n/a
POE ^f	n/a
Monitoring data of interior thermal comfort not available.	
MONITORING RESULTS AND BUILDING SIGNATURE (period 1/2012 to 12/2012)	
COOLING	
useful energy [kWh _{th} /m ² a]	n/a
delivered energy [kWh _{fin} /m ² a]	n/a
primary energy kWh _{prim} /m ² a]	n/a ^g
HEATING	
useful energy [kWh _{th} /m ² a]	25.2
delivered energy [kWh _{fin} /m ² a]	25.9
primary energy [kWh _{prim} /m ² a]	n/a ^h
VENTILATION	
delivered energy [kWh _{fin} /m ² a]	n/a
primary energy [kWh _{prim} /m ² a]	n/a ^g
LIGHTING	
delivered energy [kWh _{fin} /m ² a]	n/a
primary energy [kWh _{prim} /m ² a]	n/a ^g
APPLIANCES/PLUG LOADS	
delivered energy [kWh _{fin} /m ² a]	n/a
TOTAL BUILDING	
delivered energy [kWh _{fin} /m ² a]	n/a
primary energy [kWh _{prim} /m ² a]	n/a
onsite generation of energy	No
Monitoring data was not available.	

(a) open-plan office and normal offices, (b) public weather station in city, (c) upper comfort boundaries, (d) lower comfort boundaries, (e) during occupancy, (f) post-occupancy evaluation, (g) primary energy factor electricity: 2.7, (h) primary energy factor district heating 0.7

4.3 Administration building - court, Bruck/Mur, Austria

Special features: Special façade, innovative HVAC (incl. bivalent heat pump), lighting concept (AT02)

INFORMATION ON BUILDING AND USE

occupancy	office
number of occupants	n/a
utilization	7am-6pm
completion	1964
refurbishment	2006
number of floors	5
total floor area [m ²]	2,614
total conditioned area [m ²]	2,614
total volume [m ³]	5,770
area-to-volume ratio [m ⁻¹]	0.28 (financial admin.) 0.33 (court)



Source: shc.org/data/sites/1/publications/Adminbuilding_Bruck_.pdf

task47.iea-

BUILDING ENVELOPE

shading system	Integrated shutter, automatic operation with manual adjustability
U-values [W/(m ² K)]	exterior wall: 0.16 window: 0.3 roof: 0.11 avg. value of building: 0.37
window	solar control glazing g-value: 0.08 area: n/a m ² window-façade-ratio: n/a %

CONCEPT COOLING

environmental heat sink	GR
energy carrier	E
cooling system	NV-f, BHEX
power of system [kW _{therm}]	34.4
distribution system	air, CP-w

VENTILATION CONCEPT

operable windows	yes
night-ventilation	f
mechanical ventilation	no
air-change rate [h ⁻¹]	3
pre-cooling of air	yes

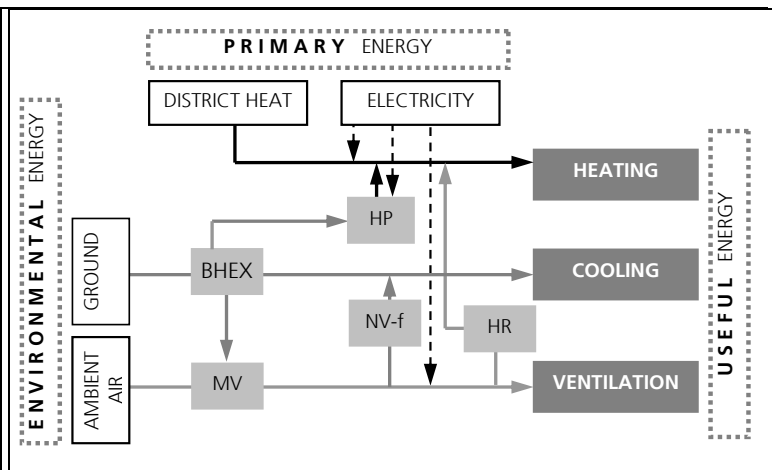

ambient air (AA) | borehole heat exchangers (BHEX) | electricity (E) | gas (G) | district heat (DH) | free (f) | ground (GR) | heat recovery (HR) | mechanical ventilation (MV) | night-ventilation (NV) | water-driven, ceiling suspended cooling panels (CP-w)

THERMAL COMFORT PERFORMANCE IN SUMMER	
year(s) of monitoring	2012-n/a
year of evaluation	2012-2014
number of rooms	n/a
ambient air temperature	public WS ^b
design temperature [°C]	20
adaptive, class II (up) ^c	n/a
adaptive, class II (low) ^d	n/a
avg. room temperature [°C] ^e	n/a
POE ^f	n/a
Monitoring data of interior thermal comfort not available.	
MONITORING RESULTS AND BUILDING SIGNATURE (period 1/2012 to 12/2012)	
COOLING	
useful energy [kWh _{th} /m ² a]	33.9.8
delivered energy [kWh _{fin} /m ² a]	n/a
primary energy kWh _{prim} /m ² a]	n/a ^g
HEATING	
useful energy [kWh _{th} /m ² a]	n/a
delivered energy [kWh _{fin} /m ² a]	50.1
primary energy [kWh _{prim} /m ² a]	n/a ^h
VENTILATION	
delivered energy [kWh _{fin} /m ² a]	n/a
primary energy [kWh _{prim} /m ² a]	n/a ^g
LIGHTING	
delivered energy [kWh _{fin} /m ² a]	n/a
primary energy [kWh _{prim} /m ² a]	n/a ^g
APPLIANCES/PLUG LOADS	
delivered energy [kWh _{fin} /m ² a]	32 ⁱ
TOTAL BUILDING	
delivered energy [kWh _{fin} /m ² a]	82.1
primary energy [kWh _{prim} /m ² a]	121.5
onsite generation of energy	Yes
Monitoring data was not available.	
(a) open-plan office and normal offices, (b) public weather station in city, (c) upper comfort boundaries, (d) lower comfort boundaries, (e) during occupancy, (f) post-occupancy evaluation, (g) primary energy factor electricity: 2.7, (h) primary energy factor district heating 0.7, (i) total electricity consumption	

4.4 Kindergarten Vejtoften, Hoje Taastrup, Denmark

Special features: Insulation and ventilation with heat recovery (DK)

Hoje Taastrup Denmark (55°64', 12°31', 11m)

INFORMATION ON BUILDING AND USE

occupancy	kindergarden
number of occupants	50
utilization	6:30am-5pm
completion	1971
refurbishment	2010
number of floors	1
total floor area [m ²]	304
total conditioned area [m ²]	330
total volume [m ³]	1,038
area-to-volume ratio [m ⁻¹]	0.37



Source: task47.iea-shc.org/data/sites/1/publications/Kindergarten-Vejtoften-Hoje-Taastrup-Denmark.pdf

BUILDING ENVELOPE

shading system	exterior overhang, fixed adjustability
U-values [W/(m ² K)]	exterior wall: 0.11 window: 0.6 roof: 0.06 avg. value of building: n/a
window	triple glazed g-value: 0.5 area: 75m ² window-façade-ratio: 25.6%

CONCEPT COOLING

environmental heat sink	-
energy carrier	-
cooling system	-
power of system [kW _{therm}]	-
distribution system	-

VENTILATION CONCEPT

operable windows	yes
night-ventilation	no
mechanical ventilation	yes
air-change rate [h ⁻¹]	0.5
pre-cooling of air	no

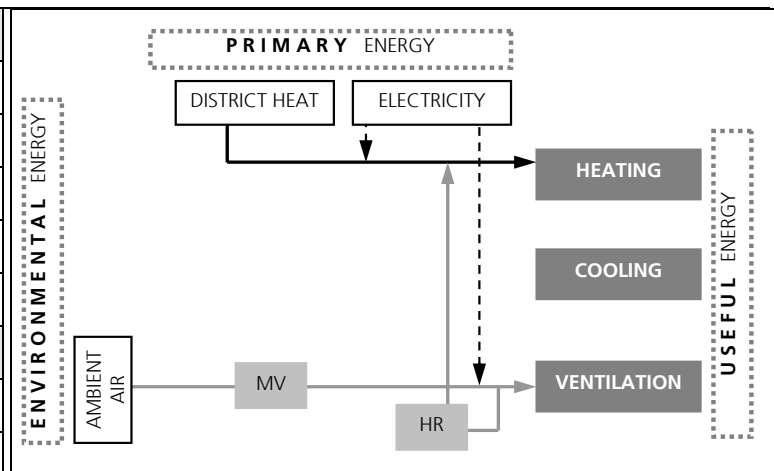

ambient air (AA) | borehole heat exchangers (BHEX) electricity (E) | gas (G) | district heat (DH) | free (f) | ground (GR) | heat recovery (HR) | mechanical ventilation (MV) | night-ventilation (NV) | water-driven, ceiling suspended cooling panels (CP-w)

THERMAL COMFORT PERFORMANCE IN SUMMER

year(s) of monitoring	2009-12
year of evaluation	2012
number of rooms	3 class-rooms
ambient air temperature	public WS ^b
design temperature [°C]	20
adaptive, class II (up) ^c	n/a
adaptive, class II (low) ^d	n/a
avg. room temperature [°C] ^e	n/a
POE ^f	n/a

Monitoring data of interior thermal comfort not available.

MONITORING RESULTS AND BUILDING SIGNATURE (period 1/2012 to 12/2012)

COOLING	
useful energy [kWh _{th} /m ² a]	n/a
delivered energy [kWh _{fin} /m ² a]	n/a
primary energy kWh _{prim} /m ² a]	n/a ^g
HEATING	
useful energy [kWh _{th} /m ² a]	47.2
delivered energy [kWh _{fin} /m ² a]	47.2
primary energy [kWh _{prim} /m ² a]	28.3 ^h
VENTILATION	
delivered energy [kWh _{fin} /m ² a]	4.6
primary energy [kWh _{prim} /m ² a]	12.1 ^g
LIGHTING	
delivered energy [kWh _{fin} /m ² a]	n/a
primary energy [kWh _{prim} /m ² a]	n/a ^g
APPLIANCES/PLUG LOADS	
delivered energy [kWh _{fin} /m ² a]	n/a
TOTAL BUILDING	
delivered energy [kWh _{fin} /m ² a]	80.9
primary energy [kWh _{prim} /m ² a]	116.0
onsite generation of energy	no

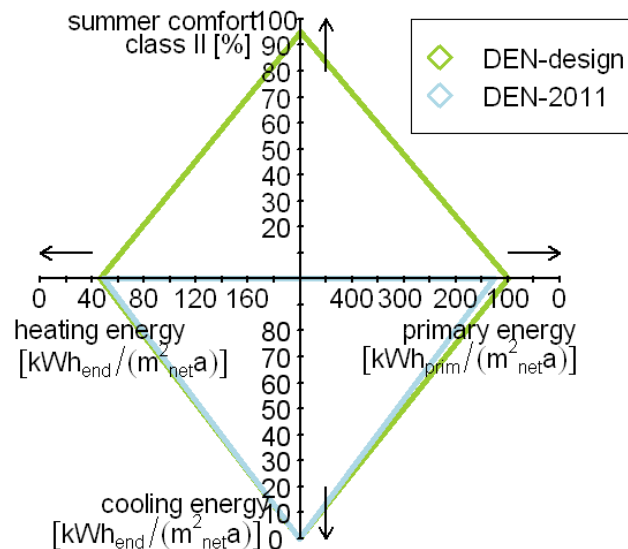

(a) open-plan office and normal offices, (b) public weather station in city, (c) upper comfort boundaries, (d) lower comfort boundaries, (e) during occupancy, (f) post-occupancy evaluation, (g) primary energy factor electricity: 2.6, (h) primary energy factor district heating 0.6

4.5 School/ Kindergarten, Ulm, Germany

Special features: Insulation with vacuum panels (GER01)

Ulm Germany (48°25', 10°1', 565m)

INFORMATION ON BUILDING AND USE

occupancy	school	
number of occupants	35	
utilization	7am-11pm	
completion	1974	
refurbishment	2004	
number of floors	2	
total floor area [m ²]	482	
total conditioned area [m ²]	517	
total volume [m ³]	1,611	
area-to-volume ratio [m ⁻¹]	0.73	

Source: Reiß, J.; 2008: Energetische Verbesserung der Bausubstanz, Teilkonzept 3: Messtechnische Validierung der Sanierung eines Gemeindezentrums unter Einsatz von Vakuumdämmpaneelen, p. 57

BUILDING ENVELOPE

shading system	exterior shutter, manual adjustability
U-values [W/(m ² K)]	exterior wall: 0.26 window: 1.07 roof: 0.17 avg. value of building: 0.46
window	triple glazed, low-E g-value: 0.51 area: 175m ² window-façade-ratio: 32%

CONCEPT COOLING

environmental heat sink	-
energy carrier	-
cooling system	-
power of system [kW _{therm}]	-
distribution system	-

VENTILATION CONCEPT

operable windows	yes
night-ventilation	no
mechanical ventilation	yes
air-change rate [h ⁻¹]	4
pre-cooling of air	no

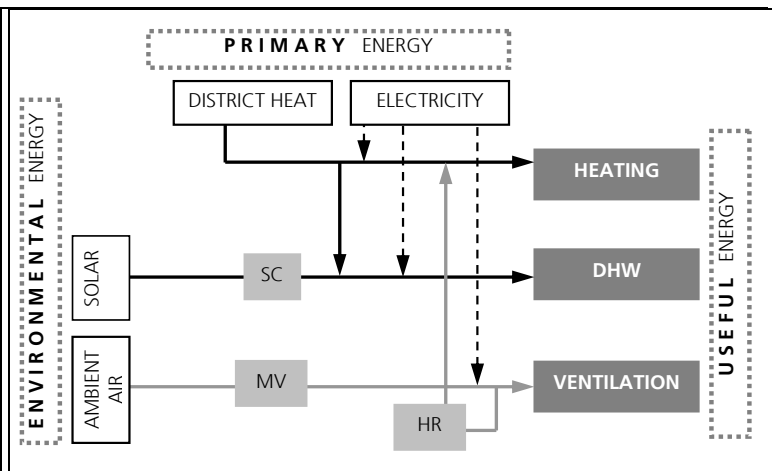

ambient air (AA) | borehole heat exchangers (BHEX) | electricity (E) | gas (G) | district heat (DH) | free (f) | ground (GR) | heat recovery (HR) | mechanical ventilation (MV) | night-ventilation (NV) | water-driven, ceiling suspended cooling panels (CP-w)

THERMAL COMFORT PERFORMANCE IN SUMMER

year(s) of monitoring	2006-7
year of evaluation	2007
number of rooms	9
ambient air temperature	Standard
design temperature [°C]	24
adaptive, class II (up) ^c	99 %
adaptive, class II (low) ^d	96 %
avg. room temperature [°C] ^e	23-27
POE ^f	No

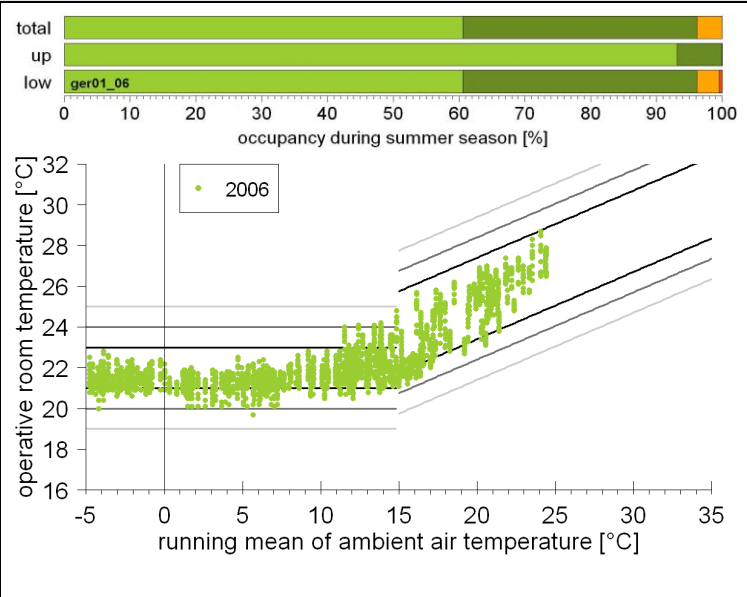

MONITORING RESULTS AND BUILDING SIGNATURE (period 1/2007 to 12/2007)

COOLING	
useful energy [kWh _{th} /m ² a]	n/a
delivered energy [kWh _{fin} /m ² a]	n/a
primary energy kWh _{prim} /m ² a]	n/a ^g
HEATING	
useful energy [kWh _{th} /m ² a]	76.5
delivered energy [kWh _{fin} /m ² a]	101.5
primary energy [kWh _{prim} /m ² a]	50.2
VENTILATION	
delivered energy [kWh _{fin} /m ² a]	5.3
primary energy [kWh _{prim} /m ² a]	13.8 ^g
LIGHTING	
delivered energy [kWh _{fin} /m ² a]	7.4
primary energy [kWh _{prim} /m ² a]	20.0 ^g
APPLIANCES/PLUG LOADS	
delivered energy [kWh _{fin} /m ² a]	12.2
TOTAL BUILDING	
delivered energy [kWh _{fin} /m ² a]	123.5
primary energy [kWh _{prim} /m ² a]	115.5
onsite generation of energy	no

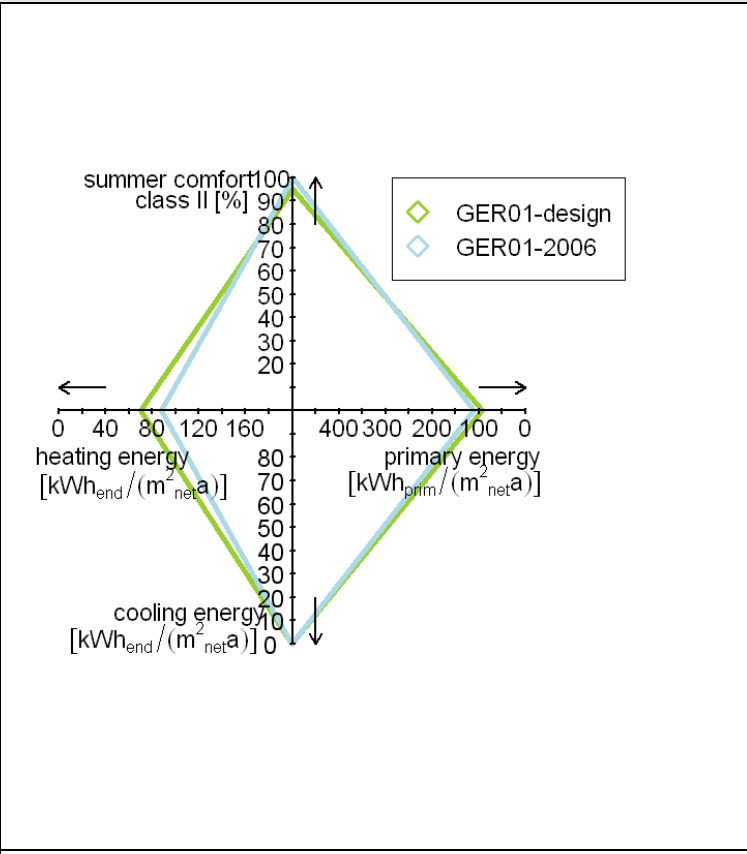

(a) open-plan office and normal offices, (b) public weather station in city, (c) upper comfort boundaries, (d) lower comfort boundaries, (e) during occupancy, (f) post-occupancy evaluation, (g) primary energy factor electricity: 2.7, (h) primary energy factor district heating 0.41

4.7 School, Olbersdorf, Germany

Special features: Retrofit of historic school building to 3-liter-building-standard (GER02)

Olbersdorf Germany (50°88', 14°77', 273m)

INFORMATION ON BUILDING AND USE

occupancy	school	
number of occupants	180	
utilization	5am-4pm	
completion	1928	
refurbishment	2011	
number of floors	4	
total floor area [m ²]	n/k	
total conditioned area [m ²]	4,440	
total volume [m ³]	17,880	
area-to-volume ratio [m ⁻¹]	0.25	

Source: <http://www.eneff-schule.de/index.php/Demonstrationsobjekte/3-Liter-Haus-Schulen/3-liter-haus-schule-in-olbersdorf-landkreis-loebauzittau.html>

BUILDING ENVELOPE

shading system	Electrochromic glazing (South), lamella in spacing between glasses
U-values [W/(m ² K)]	exterior wall: 0.34 window: 1.0 roof: 0.22 avg. value of building: 0.42
window	boxtype glazing g-value: 0.1 – 0.32 (electrochromic) area: n/a m ² window-façade-ratio: n/a%

CONCEPT COOLING

environmental heat sink	GR
energy carrier	G
cooling system	BHEX
power of system [kW _{therm}]	15-220
distribution system	CP-w

VENTILATION CONCEPT

operable windows	yes
night-ventilation	no
mechanical ventilation	yes
air-change rate [h ⁻¹]	n/a
pre-cooling of air	no

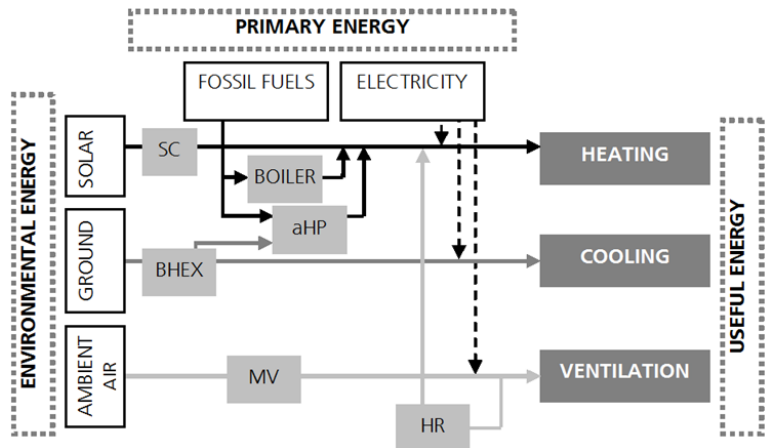

ambient air (AA) | borehole heat exchangers (BHEX) | electricity (E) | gas (G) | district heat (DH) | free (f) | ground (GR) | heat recovery (HR) | mechanical ventilation (MV) | night-ventilation (NV) | water-driven, ceiling suspended cooling panels (CP-w)

THERMAL COMFORT PERFORMANCE IN SUMMER

year(s) of monitoring	2011-12
year of evaluation	2012
number of rooms	11 monitored
ambient air temperature	public WS ^b
design temperature [°C]	n/a
adaptive, class II (up) ^c	99 %
adaptive, class II (low) ^d	96 %
avg. room temperature [°C] ^e	22-25
POE ^f	yes

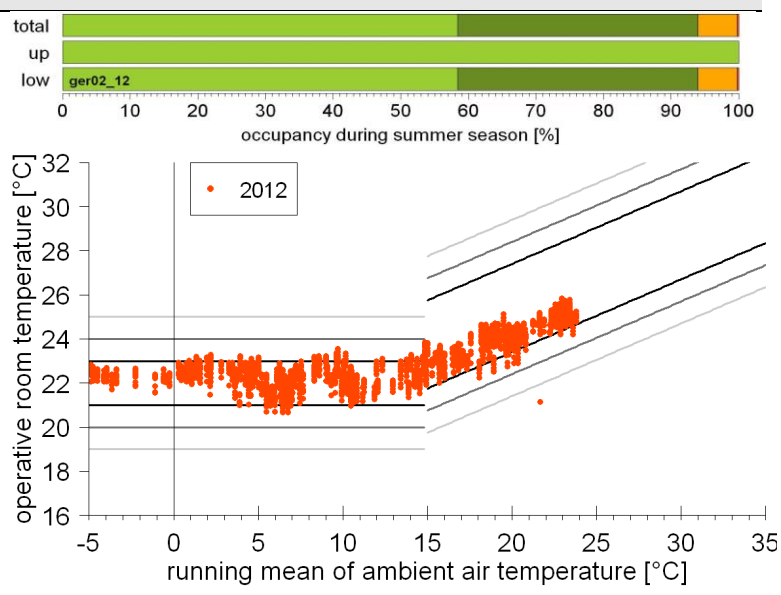

MONITORING RESULTS AND BUILDING SIGNATURE (period 1/2012 to 12/2012)

COOLING	
useful energy [kWh _{th} /m ² a]	n/a
delivered energy [kWh _{fin} /m ² a]	n/a
primary energy kWh _{prim} /m ² a]	n/a ^g
HEATING	
useful energy [kWh _{th} /m ² a]	29.7
delivered energy [kWh _{fin} /m ² a]	31.9
primary energy [kWh _{prim} /m ² a]	35.9 ^h
VENTILATION	
delivered energy [kWh _{fin} /m ² a]	0.1
primary energy [kWh _{prim} /m ² a]	0.26 ^g
LIGHTING	
delivered energy [kWh _{fin} /m ² a]	3.3
primary energy [kWh _{prim} /m ² a]	8.58 ^g
APPLIANCES/PLUG LOADS	
delivered energy [kWh _{fin} /m ² a]	n/a
TOTAL BUILDING	
delivered energy [kWh _{fin} /m ² a]	38.2
primary energy [kWh _{prim} /m ² a]	43.54
onsite generation of energy	no

Monitoring data was not available.

(a) open-plan office and normal offices, (b) public weather station in city, (c) upper comfort boundaries, (d) lower comfort boundaries, (e) during occupancy, (f) post-occupancy evaluation, (g) primary energy factor electricity: 2.7, (h) primary energy factor fossil fuels 1.1

4.9 Printing workshop & Office Building, Karlsruhe, Germany

Special features: Water-based cooling (GER03)

Karlsruhe Germany (49°0', 8°24', 115m)

INFORMATION ON BUILDING AND USE

occupancy	office
number of occupants	50
utilization	7am-11pm
completion	1978
refurbishment	2005
number of floors	2
total floor area [m ²]	1,390
total conditioned area [m ²]	1,111
total volume [m ³]	4,910
area-to-volume ratio [m ⁻¹]	0.27



Source: Patrick Beuchert, Karlsruhe

BUILDING ENVELOPE

shading system	exterior venetian blinds, automatic operation, shading factor 0.2
U-values [W/(m ² K)]	exterior wall: 0.3 window: 1.4 roof: 0.19 avg. value of building: 0.54
window	solar control glazing g-value: 0.55 area: 473m ² window-façade-ratio: 20-87%

CONCEPT COOLING

environmental heat sink	AA, GR
energy carrier	E
cooling system	NV-f, BHEX
power of system [kW _{therm}]	10
distribution system	air, CP-w

VENTILATION CONCEPT

operable windows	yes
night-ventilation	f
mechanical ventilation	yes
air-change rate [h ⁻¹]	1
pre-cooling of air	yes

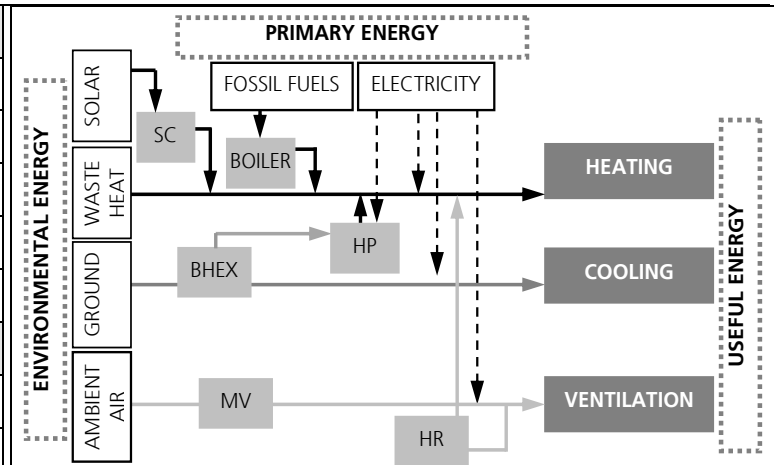

ambient air (AA) | borehole heat exchangers (BHEX) | electricity (E) | gas (G) | district heat (DH) | free (f) | ground (GR) | heat recovery (HR) | mechanical ventilation (MV) | night-ventilation (NV) | water-driven, ceiling suspended cooling panels (CP-w)

THERMAL COMFORT PERFORMANCE IN SUMMER

year(s) of monitoring	2008-10
year of evaluation	2008
number of rooms	10
ambient air temperature	public WS ^b
design temperature [°C]	26
adaptive, class II (up) ^c	88%
adaptive, class II (low) ^d	97%
avg. room temperature [°C] ^e	23-27
POE ^f	yes

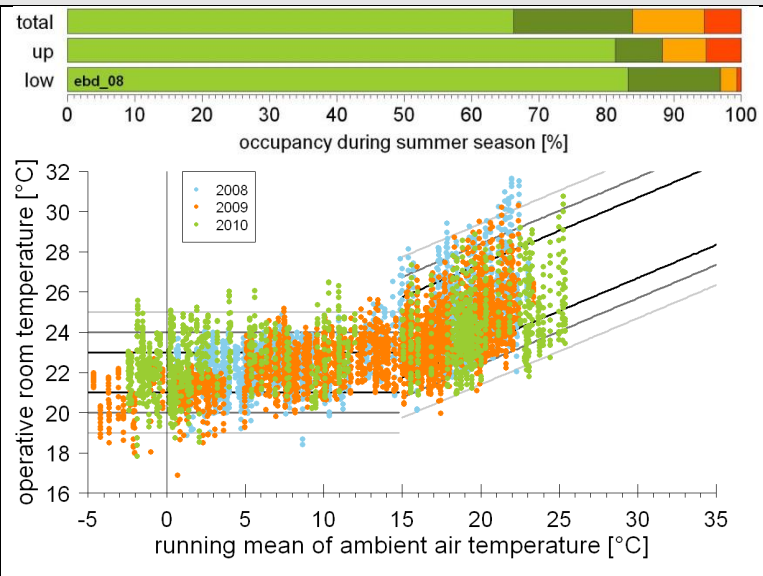

MONITORING RESULTS AND BUILDING SIGNATURE (period 1/2008 to 12/2008)

COOLING	
useful energy [kWh _{th} /m ² a]	20.3
delivered energy [kWh _{fin} /m ² a]	5.9
primary energy kWh _{prim} /m ² a]	14.6 ^g
HEATING	
useful energy [kWh _{th} /m ² a]	79.9
delivered energy [kWh _{fin} /m ² a]	98.3
primary energy [kWh _{prim} /m ² a]	102.0 ^h
VENTILATION	
delivered energy [kWh _{fin} /m ² a]	12.2
primary energy [kWh _{prim} /m ² a]	30.5 ^g
LIGHTING	
delivered energy [kWh _{fin} /m ² a]	23.5
primary energy [kWh _{prim} /m ² a]	59.1 ^g
APPLIANCES/PLUG LOADS	
delivered energy [kWh _{fin} /m ² a]	n/k
TOTAL BUILDING	
delivered energy [kWh _{fin} /m ² a]	140.0
primary energy [kWh _{prim} /m ² a]	206.3
onsite generation of energy	no

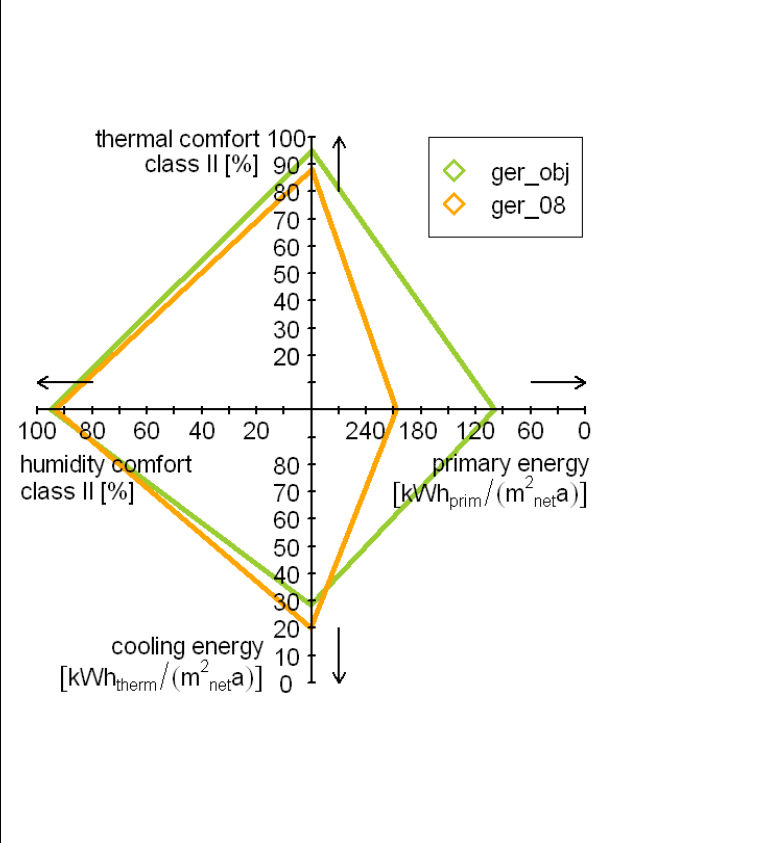

(a) open-plan office and normal offices, (b) public weather station in city, (c) upper comfort boundaries, (d) lower comfort boundaries, (e) during occupancy, (f) post-occupancy evaluation, (g) primary energy factor electricity: 2.7, (h) primary energy factor heating 1.04

4.10 Office and workshop building, Freiburg, Germany

Special features: Ventilation system integrated in prefabricated insulation panels (GER04)

Freiburg Germany (48°0', 7°49', 253m)

INFORMATION ON BUILDING AND USE

occupancy	office	
number of occupants	42	
utilization	9am-4pm	
completion	1975	
refurbishment	2011	
number of floors	3	
total floor area [m ²]	1,749	
total conditioned area [m ²]	1,490	
total volume [m ³]	9,168	
area-to-volume ratio [m ⁻¹]	0.32	

Source: task47.iea-shc.org/data/sites/1/publications/Task47-ISE-Campus-Building-Germany.pdf

BUILDING ENVELOPE

shading system	Exterior shutter, automatic operation with manual adjustability
U-values [W/(m ² K)]	exterior wall: 0.16 window: 1.68 roof: 0.21 avg. value of building: 0.41
window	double glazed, low-E g-value: 0.6 area: 214m ² window-façade-ratio: 17%

CONCEPT COOLING

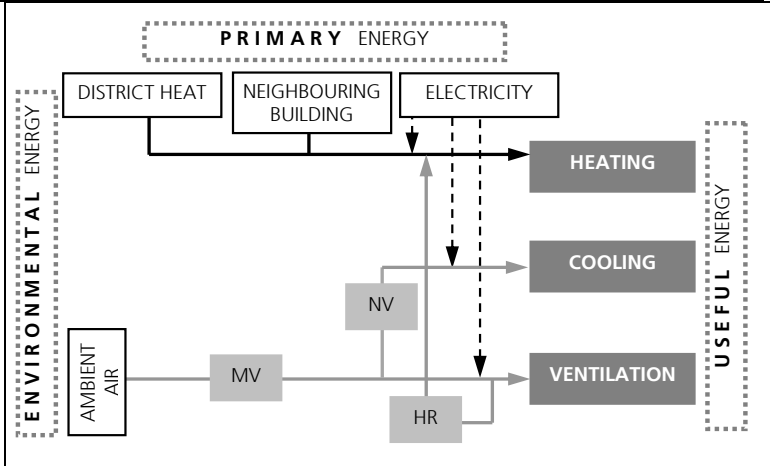
environmental heat sink	AA	
energy carrier	E	
cooling system	NV	
power of system [kW _{therm}]	n/k	
distribution system	air	
VENTILATION CONCEPT		
operable windows	yes	
night-ventilation	yes	
mechanical ventilation	yes	
air-change rate [h ⁻¹]	n/a	
pre-cooling of air	no	

ambient air (AA) | borehole heat exchangers (BHEX) | electricity (E) | gas (G) | district heat (DH) | free (f) | ground (GR) | heat recovery (HR) | mechanical ventilation (MV) | night-ventilation (NV) | water-driven, ceiling suspended cooling panels (CP-w)

THERMAL COMFORT PERFORMANCE IN SUMMER			
year(s) of monitoring	2012-13	Monitoring data of interior thermal comfort not available.	
year of evaluation	2012		
number of rooms	n/a		
ambient air temperature	Standard		
design temperature [°C]	n/a		
adaptive, class II (up) ^c	n/a		
adaptive, class II (low) ^d	n/a		
avg. room temperature [°C] ^e	n/a		
POE ^f	n/a		
MONITORING RESULTS AND BUILDING SIGNATURE (period 1/2012 to 12/2012)			
COOLING			
useful energy [kWh _{th} /m ² a]	n/a	Monitoring data was not available.	
delivered energy [kWh _{fin} /m ² a]	n/a		
primary energy kWh _{prim} /m ² a]	n/a ^g		
HEATING			
useful energy [kWh _{th} /m ² a]	n/a		
delivered energy [kWh _{fin} /m ² a]	64.7		
primary energy [kWh _{prim} /m ² a]	12.3 ^h		
VENTILATION			
delivered energy [kWh _{fin} /m ² a]	Incl. in Plug Loads		
primary energy [kWh _{prim} /m ² a]	n/a ^g		
LIGHTING			
delivered energy [kWh _{fin} /m ² a]	Incl. in Plug Loads		
primary energy [kWh _{prim} /m ² a]	n/a ^g		
APPLIANCES/PLUG LOADS			
delivered energy [kWh _{fin} /m ² a]	112.7		
TOTAL BUILDING			
delivered energy [kWh _{fin} /m ² a]	216.0	(a) open-plan office and normal offices, (b) public weather station in city, (c) upper comfort boundaries, (d) lower comfort boundaries, (e) during occupancy, (f) post-occupancy evaluation, (g) primary energy factor electricity: 2.7, (h) primary energy factor district heating 0.19	
primary energy [kWh _{prim} /m ² a]	316.5		
onsite generation of energy	no		

4.11 School, Cottbus, Germany

Special features: Retrofit of typical school made from prefabricated slabs to passive-house-standard (GER05)

INFORMATION ON BUILDING AND USE

occupancy	school	
number of occupants	500	
utilization	7am-4pm	
completion	1974	
refurbishment	2012	
number of floors	3	
total floor area [m ²]	10,863	
total conditioned area [m ²]	9,509	
total volume [m ³]	40,954	
area-to-volume ratio [m ⁻¹]	0.27	

Source: <http://www.enob.info/de/slideshow/bilder/sanierung-einer-plattenbau-typenschule-nach-passivhaus-standard/gymnasium-cottbus-noerdlicher-pausenhof-1/projekte/>

BUILDING ENVELOPE

shading system	exterior
U-values [W/(m ² K)]	exterior wall: 0.3 window: 1.4 roof: 0.19 avg. value of building: 0.54
window	solar control glazing g-value: 0.55 area: 473m ² window-façade-ratio: 20-87%

CONCEPT COOLING

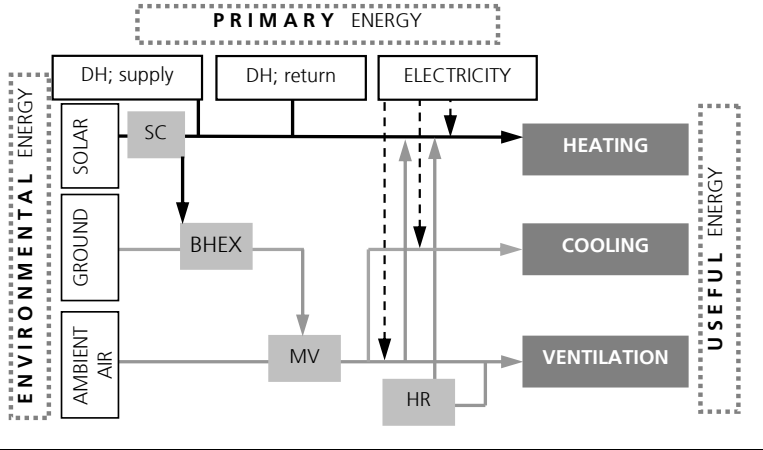
environmental heat sink	AA, GR	
energy carrier	E	
cooling system	MV, BHEX	
power of system [kW _{therm}]	n/a	
distribution system	air, CP-w	
VENTILATION CONCEPT		
operable windows	Yes	
night-ventilation	No	
mechanical ventilation	Yes	
air-change rate [h ⁻¹]	n/a	
pre-cooling of air	Yes	

ambient air (AA) | borehole heat exchangers (BHEX) | electricity (E) | gas (G) | district heat (DH) | free (f) | ground (GR) | heat recovery (HR) | mechanical ventilation (MV) | night-ventilation (NV) | water-driven, ceiling suspended cooling panels (CP-w)

THERMAL COMFORT PERFORMANCE IN SUMMER-	
year(s) of monitoring	2012-14
year of evaluation	2013
number of rooms	n/a
ambient air temperature	Standard
design temperature [°C]	26
adaptive, class II (up) ^c	-
adaptive, class II (low) ^d	-
avg. room temperature [°C] ^e	-
POE ^f	yes
Monitoring data of interior thermal comfort not available.	
MONITORING RESULTS AND BUILDING SIGNATURE (period 1/2013 to 12/2013)	
COOLING	
useful energy [kWh _{th} /m ² a]	n/a
delivered energy [kWh _{fin} /m ² a]	n/a
primary energy kWh _{prim} /m ² a]	n/a ^g
HEATING	
useful energy [kWh _{th} /m ² a]	15.6
delivered energy [kWh _{fin} /m ² a]	29.0
primary energy [kWh _{prim} /m ² a]	20.3 ^h
VENTILATION	
delivered energy [kWh _{fin} /m ² a]	n/a
primary energy [kWh _{prim} /m ² a]	n/a ^g
LIGHTING	
delivered energy [kWh _{fin} /m ² a]	n/a
primary energy [kWh _{prim} /m ² a]	n/a ^g
APPLIANCES/PLUG LOADS	
delivered energy [kWh _{fin} /m ² a]	4.62
TOTAL BUILDING	
delivered energy [kWh _{fin} /m ² a]	n/a
primary energy [kWh _{prim} /m ² a]	32.3
onsite generation of energy	planned
Monitoring data was not available.	
(a) open-plan office and normal offices, (b) public weather station in city, (c) upper comfort boundaries, (d) lower comfort boundaries, (e) during occupancy, (f) post-occupancy evaluation, (g) primary energy factor electricity: 2.6, (h) primary energy factor district heating 0.7	

4.12 Schüco Italian Headquarter, Padova, Italy

Special features: Water-based cooling (ITA)

Padova Italy (45°23', 11°55', 8m)

INFORMATION ON BUILDING AND USE

occupancy	office
number of occupants	90
utilization	8am-8pm
completion	1990
refurbishment	2009
number of floors	2
total floor area [m ²]	1,334 (ret.) ^j
total conditioned area [m ²]	1,334 (ret.) ^j
total volume [m ³]	5,471 (ret.) ^j
area-to-volume ratio [m ⁻¹]	0.24



Source: task47.iea-shc.org/data/sites/1/publications/Schueco-Italia-Headquarter.pdf

BUILDING ENVELOPE

shading system	External (roller micro-)louvers ($g_{\text{glaz+shad}} = 0.06$), internal roller blinds, automated sun blind control system
U-values [W/(m ² K)]	exterior wall: 0.378 (renovation), 0.25 (new built) window: 1.6 roof: 0.296
window	Low-emissivity glass g-value: 0.06 – 0.1 area: 473m ² window-façade-ratio: 20-87%

CONCEPT COOLING

environmental heat sink	Air
energy carrier	Solar, E
cooling system	chiller
power of system [kW _{therm}]	15
distribution system	air, CP-w

VENTILATION CONEPT

operable windows	yes
night-ventilation	no
mechanical ventilation	yes
air-change rate [h ⁻¹]	2.7
pre-cooling of air	yes

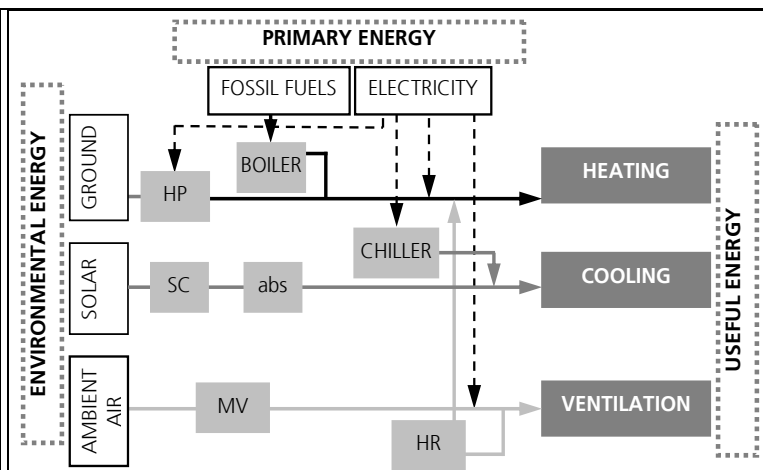

ambient air (AA) | borehole heat exchangers (BHEX) | electricity (E) | gas (G) | district heat (DH) | free (f) | ground (GR) | heat recovery (HR) | mechanical ventilation (MV) | night-ventilation (NV) | water-driven, ceiling suspended cooling panels (CP-w)

THERMAL COMFORT PERFORMANCE IN SUMMER	
year(s) of monitoring	2008-09
year of evaluation	2009-n/a
number of rooms	10
ambient air temperature	public WS ^b
design temperature [°C]	26
adaptive, class II (up) ^c	n/a
adaptive, class II (low) ^d	n/a
avg. room temperature [°C] ^e	n/a
POE ^f	n/a
Monitoring data of interior thermal comfort not available.	
MONITORING RESULTS AND BUILDING SIGNATURE (design values)	
COOLING	
useful energy [kWh _{th} /m ² a]	n/a
delivered energy [kWh _{fin} /m ² a]	16.5
primary energy kWh _{prim} /m ² a]	35.8 ^g
HEATING	
useful energy [kWh _{th} /m ² a]	n/a
delivered energy [kWh _{fin} /m ² a]	61.5
primary energy [kWh _{prim} /m ² a]	61.5 ^h
VENTILATION	
delivered energy [kWh _{fin} /m ² a]	20.3
primary energy [kWh _{prim} /m ² a]	44.0 ^g
LIGHTING	
delivered energy [kWh _{fin} /m ² a]	n/a
primary energy [kWh _{prim} /m ² a]	n/a ^g
APPLIANCES/PLUG LOADS	
delivered energy [kWh _{fin} /m ² a]	4.34
TOTAL BUILDING	
delivered energy [kWh _{fin} /m ² a]	102.5
primary energy [kWh _{prim} /m ² a]	150.7
onsite generation of energy	yes
Monitoring data was not available.	
(a) open-plan office and normal offices, (b) public weather station in city, (c) upper comfort boundaries, (d) lower comfort boundaries, (e) during occupancy, (f) post-occupancy evaluation, (g) primary energy factor electricity: 2.17, (h) primary energy factor fossil fuels 1.0, (i) retrofitted	

4.13 Solbraaveien Office Center, Asker, Norway

Special features: Water-based cooling (NOR01)

Asker Norway (59°8', 10°4', 25m)

INFORMATION ON BUILDING AND USE

occupancy	office	 <p>Source: task47.iea-shc.org/data/sites/1/publications/Solbraaveien-Renovation-Project.pdf</p>
number of occupants	50	
utilization	8am-6pm	
completion	1980	
refurbishment	2013	
number of floors	5	
total floor area [m ²]	1,390	
total conditioned area [m ²]	9,365	
total volume [m ³]	30,430	
area-to-volume ratio [m ⁻¹]	0.31	

BUILDING ENVELOPE

shading system	Internal shading
U-values [W/(m ² K)]	exterior wall: 0.16 window: 1.0 roof: 0.1 avg. value of building: 0.54
window	Glass-façade system with passive house windows, sun reflecting glass to SE

CONCEPT COOLING

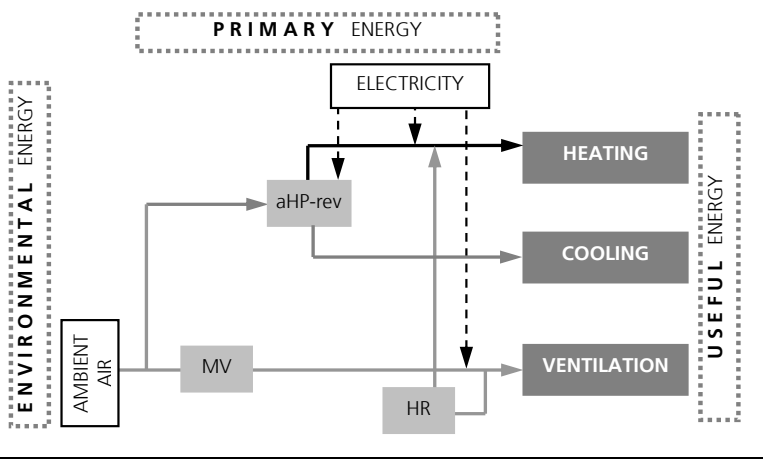
environmental heat sink	AA	 <p>The diagram illustrates the energy flows between 'ENVIRONMENTAL ENERGY' (Ambient Air), 'PRIMARY ENERGY' (Electricity), and 'USEFUL ENERGY' (Heating, Cooling, Ventilation). Ambient air (AA) is processed by Mechanical Ventilation (MV) and Heat Recovery (HR). Electricity (E) is used to power an aHP-rev system, which provides heating and cooling. HR also contributes to heating and ventilation.</p>
energy carrier	E	
cooling system	HP	
power of system [kW _{therm}]	226	
distribution system	air, CP-w	
VENTILATION CONCEPT		
operable windows	yes	
night-ventilation	yes	
mechanical ventilation	yes	
air-change rate [h ⁻¹]	2.5	
pre-cooling of air	yes	

ambient air (AA) | borehole heat exchangers (BHEX) | electricity (E) | gas (G) | district heat (DH) | free (f) | ground (GR) | heat recovery (HR) | mechanical ventilation (MV) | night-ventilation (NV) | water-driven, ceiling suspended cooling panels (CP-w)

THERMAL COMFORT PERFORMANCE IN SUMMER			
year(s) of monitoring	n/a	Monitoring data of interior thermal comfort not available.	
year of evaluation	2014-n/a		
number of rooms	n/a		
ambient air temperature	public WS ^b		
design temperature [°C]	24		
adaptive, class II (up) ^c	n/a		
adaptive, class II (low) ^d	n/a		
avg. room temperature [°C] ^e	n/a		
POE ^f	n/a		
MONITORING RESULTS AND BUILDING SIGNATURE (design values)			
COOLING			
useful energy [kWh _{th} /m ² a]	7.0	Monitoring data was not available.	
delivered energy [kWh _{fin} /m ² a]	2.6		
primary energy kWh _{prim} /m ² a]	2.8 ^g		
HEATING			
useful energy [kWh _{th} /m ² a]	20.3		
delivered energy [kWh _{fin} /m ² a]	8.7		
primary energy [kWh _{prim} /m ² a]	n/a ^h		
VENTILATION			
delivered energy [kWh _{fin} /m ² a]	8.8		
primary energy [kWh _{prim} /m ² a]	13.2 ^g		
LIGHTING			
delivered energy [kWh _{fin} /m ² a]	16.0		
primary energy [kWh _{prim} /m ² a]	24.0 ^g		
APPLIANCES/PLUG LOADS			
delivered energy [kWh _{fin} /m ² a]	19.2		
TOTAL BUILDING			
delivered energy [kWh _{fin} /m ² a]	36.0	(a) open-plan office and normal offices, (b) public weather station in city, (c) upper comfort boundaries, (d) lower comfort boundaries, (e) during occupancy, (f) post-occupancy evaluation, (g) primary energy factor electricity: 1.5, (h) primary energy factor heating n/a	
primary energy [kWh _{prim} /m ² a]	44.0		
onsite generation of energy	no		

4.14 Powerhouse Kjørbo, Sandvika, Norway

Special features: Water-based cooling (NOR02)

Oslo Norway (59°9', 10°5', 1m)

INFORMATION ON BUILDING AND USE

occupancy	office	
number of occupants	240	
utilization	8am-8pm	
completion	1980	
refurbishment	2014	
number of floors	4	
total floor area [m ²]	5,200	
total conditioned area [m ²]	5,200	
total volume [m ³]	n/a	
area-to-volume ratio [m ⁻¹]	n/a	

Source: task47.iea-shc.org/data/sites/1/publications/Task47-Power-House-Kj%C3%B8rbo-Norway.pdf

BUILDING ENVELOPE

shading system	external shading integrated in façade
U-values [W/(m ² K)]	Ext. wall: 0.15 window: 0.8 roof: 0.08 Floor: on ground: 0.12, on basement: 0.16
window	g-value: 0.68 window-façade-ratio: 40/60

CONCEPT COOLING

environmental heat sink	AA, GR
energy carrier	E
cooling system	AC, MV
power of system [kW _{therm}]	10
distribution system	air, radiator

VENTILATION CONEPT

operable windows	yes
night-ventilation	f
mechanical ventilation	yes
air-change rate [h ⁻¹]	0.23
pre-cooling of air	yes

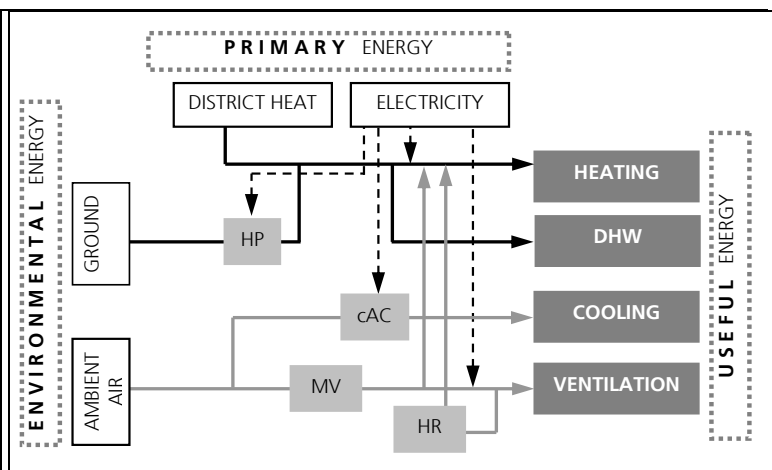

ambient air (AA) | borehole heat exchangers (BHEX) | electricity (E) | gas (G) | district heat (DH) | free (f) | ground (GR) | heat recovery (HR) | mechanical ventilation (MV) | night-ventilation (NV) | water-driven, ceiling suspended cooling panels (CP-w)

THERMAL COMFORT PERFORMANCE IN SUMMER	
year(s) of monitoring	2014
year of evaluation	2014
number of rooms	10
ambient air temperature	public WS ^b
design temperature [°C]	24
adaptive, class II (up) ^c	n/a
adaptive, class II (low) ^d	n/a
avg. room temperature [°C] ^e	n/a
POE ^f	n/a
Monitoring data of interior thermal comfort not available.	
MONITORING RESULTS AND BUILDING SIGNATURE (design values)	
COOLING	
useful energy [kWh _{th} /m ² a]	18.7
delivered energy [kWh _{fin} /m ² a]	2.1
primary energy kWh _{prim} /m ² a]	n/a ^g
HEATING	
useful energy [kWh _{th} /m ² a]	17.4
delivered energy [kWh _{fin} /m ² a]	6.3
primary energy [kWh _{prim} /m ² a]	n/a ^h
VENTILATION	
delivered energy [kWh _{fin} /m ² a]	3.0
primary energy [kWh _{prim} /m ² a]	n/a ^g
LIGHTING	
delivered energy [kWh _{fin} /m ² a]	6.6
primary energy [kWh _{prim} /m ² a]	n/a ^g
APPLIANCES/PLUG LOADS	
delivered energy [kWh _{fin} /m ² a]	25.4
TOTAL BUILDING	
delivered energy [kWh _{fin} /m ² a]	50
primary energy [kWh _{prim} /m ² a]	n/a
onsite generation of energy	yes
Monitoring data was not available.	

(a) open-plan office and normal offices, (b) public weather station in city, (c) upper comfort boundaries, (d) lower comfort boundaries, (e) during occupancy, (f) post-occupancy evaluation, (g) primary energy factor electricity: 1.5, (h) primary energy factor heating n/a

5 Energetic Analysis

Doreen Kalz, Fraunhofer ISE
 Benjamin Köhler, Fraunhofer ISE
 Johann Reiß, Fraunhofer IBP
 Roman Jakobiack, Daylighting
 Claudia Dankl, ÖGUT
 Ezilda Costanzo, ENEA
 Kirsten Engelund Thomsen, AAU
 Anna Svensson, SINTEF

In the following the energy demand of the monitored and evaluated demonstration buildings introduced in chapter 4 is described and analysed¹. The analysis is divided in sub-chapters dealing with the following topics:

- **Chapter 5.1:** the comparison of delivered and primary energy demand
- **Chapter 5.2:** the analysis of the heating energy demand
- **Chapter 5.3:** the analysis of cooling energy demand
- **Chapter 5.4:** detailed analysis of the delivered and primary energy demand before and after the renovation
- **Chapter 5.5:** comparison of the results with national buildings stocks and benchmarks in order to classify the demonstration buildings.

For some buildings energy data is not available for an in depth analysis of the energy performance before and after the retrofit and during the monitoring period(s). An overview of the available data is given in Table 8. It has to be mentioned that the monitored heating and cooling energy demand analysed and described in the following chapters are not climate adjusted and represent the actual values of the respective monitoring years.

Table 7: List of buildings evaluated.

Abbreviation	Description
AT01	School building, Schwanenstadt
AT02	Administration building (financial administration, court), Bruck/Mur
DK	Kindergarten Vejtoften, Hoje Taastrup
GER01	School/ Kindergarten, Ulm
GER02	School building, Olbersdorf
GER03	Printing workshop and office building, Karlsruhe
GER04	Office and workshop building, Freiburg
GER05	School building, Cottbus
ITA	Headquarter Schüco Italy, Padova
NOR01	Solbraaveien Office Center, Asker
NOR02	Powerhouse Kjørbo, Sandvika

¹ For buildings AT02, ITA, NOR01 and NOR02 no monitoring data is available yet as the buildings were finished recently, refurbishment is not finalized or data was not available. In these cases the energy consumption before the retrofit can only be compared with the design energy demand.

Table 8: Available data of the demonstration buildings.

Building	Primary energy before	Delivered energy before	Monitoring data	Primary energy design	Delivered energy design	Detailed electricity demand (diff. services)
AT01	No	Yes	Yes	Yes	Yes	Yes
AT02	No	No	No	Yes	Yes	No
DK	Yes	Yes	Yes	Yes	Yes	Yes
GER01	Yes	Yes	Yes	Yes	Yes	Only monitoring
GER02	Yes	Yes	Yes	Yes	Yes	Partly
GER03	Yes	Yes	Yes	Yes	Yes	Not before
GER04	No	No	Yes	No	No	No
GER05	Yes	Yes	Yes	Yes	Yes	No
ITA	Yes	Yes	No	Yes	Yes	Partly
NOR01	No	Yes	No	No	Yes	Before & design
NOR02	No	Yes	No	No	Yes	Before & design

5.1 Analysis of delivered and primary energy

The demonstration buildings had a delivered heat demand before the retrofit measures between 75 and 216 kWh_{th}/(m²*a) with the highest demand in the building GER02 (216 kWh_{th}/(m²*a)) and GER01 (195 kWh_{th}/(m²*a)). The lowest heat demands were observed in the buildings NOR02 (75 kWh_{th}/(m²*a)) and ITA (97 kWh_{th}/(m²*a)). The overall delivered energy demand before the retrofit was between 102 (ITA) and 228 kWh_{th}/(m²*a) (GER02). The primary energy demand for heating of the demonstration buildings before retrofit was in the range of 71 to 216 kWh_{prim}/(m²*a) with the lowest demand in the building DK (district heating) and the highest in GER02 (gas boilers, high temperature distribution system). The overall primary energy demand was highest in AT02 (464 kWh_{prim}/(m²*a)) and the lowest in ITA (115 kWh_{prim}/(m²*a)). The main reasons for the low primary energy demand in ITA are the primary energy factor for natural gas of 1 in Italy and the comparably low electricity demand, which is mainly due to the fact that there was no mechanical ventilation and cooling system installed before the retrofit. A possible reason for the high primary energy demand in AT02 is mainly the use of fossil fuels for heating and hot water in a poorly insulated building with outdated heat supply technology.

All retrofit projects had very ambiguous energy saving targets. The design for delivered heating energy demand of the projects is between 43 and 70 kWh_{th}/(m²*a) with the lowest demand in the building NOR02. The particular design aims savings between 37 (ITA) and 92 % (NOR02) compared to the energy use before the retrofit.

Concerning the total delivered energy demand after retrofit –derived from monitoring results–, the reduction achieved is lower than anticipated; 43 to 230 kWh_{fin}/(m²*a) with the highest energy demands in buildings with workshop and/ or laboratory areas (in these cases the total energy demand was analysed and not only the energy demand for

the building services). The designed savings correspond to reductions between 52 and 86 % and an increase in the total energy demand in the building ITA. The increase in total delivered energy demand also leads to an increase in the primary energy demand of this building of 31 %. The reason is that there was no mechanical cooling in the building before the renovation. The new installed cooling devices lead to an increase in electricity and therefore in the primary energy consumption of the whole building. Furthermore, the delivered energy consumption is constant as the increasing energy demand of the mechanical cooling undoes the savings in heating energy demand. In the other projects a decrease in primary energy between 39 and 82 % was planned.

The delivered and primary energy consumption of the demonstration buildings before the renovation, during the monitoring and the design are compared in Figure 4. In most cases both, the delivered and primary energy consumption of the buildings were reduced significantly (delivered energy up to 86 %, primary energy savings up to 85 %).

In several demonstration buildings the monitored energy consumption is even below the design: buildings AT01 reduction of primary energy by 25 kWh_{prim}/(m²*a), GER02 reduction of total delivered and primary energy by 7.6 kWh/(m²*a), GER04 reduction of delivered energy by 15 – 53 kWh_{fin}/(m²*a) and reduction of primary energy by 14 – 20 kWh/(m²*a), and GER05 reduction of delivered energy by 3 kWh_{fin}/(m²*a) and primary energy by 13 kWh_{prim}/(m²*a). Possible reasons are the user behaviour, but also the climate conditions during the years of monitoring. In the other buildings, from which monitoring data is available, the measured consumption is above the design. In these cases it can be seen, however, that the energy consumption is decreasing during the years of operation. The main reason for the development is that the monitoring data can help to optimise the control and interaction of the building services. Especially in the buildings DK and GER03 this development can be seen clearly. Furthermore, a change in building technology during the monitoring phase is a possible reason for changes in the overall delivered and primary energy consumption. This is the case in GER03 in which a heat pump for H/C was installed during the monitoring period replacing other heat supply technologies (decrease in energy consumption between monitoring years two and four).

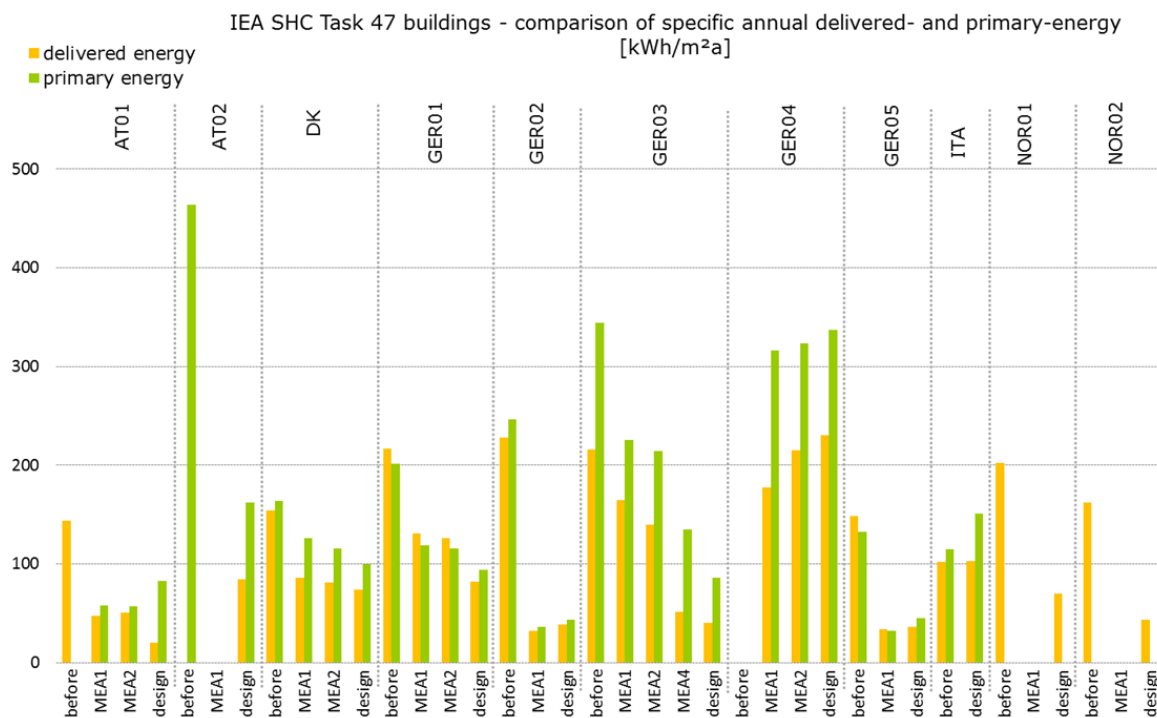

Figure 4: Specific delivered and primary energy demand of evaluated and monitored buildings. The abbreviation MEA stands for "measurement period".

5.2 Heating Energy Analysis

A major driving factor for the energetic retrofit of buildings is the reduction of the heating energy demand; especially in countries with heating-dominated climates like in central and northern Europe where the heating plant is usually the main energy consumer. In Figure 5 the delivered and primary heat demand of the demonstration buildings before the renovation, during the monitoring period and the design are compared. In all demonstration buildings with available data, the delivered and primary heat demand was reduced significantly.

The delivered heat consumption in the buildings was between 75 and 216 kWh_{th}/(m²*a) and the primary energy demand for heating – depending on the type of fuel – between 17 and 216 kWh_{prim}/(m²*a). The pursued reduction in delivered energy demand through the retrofit measures was between 37 and 92 % and for the primary energy consumption between 37 and 84 %.

In the first year of monitoring the demonstration buildings achieved a reduction between 15 and 85 %. Especially in the building GER03, the savings in the first year of the monitoring were below the expected savings. But in the measurement period MEA4, the highest reduction (93 %) was achieved in the building GER03 after the final renovation between monitoring years two (MEA2) and four (MEA4) and a constant optimization of the building services and its control. Comparing the achieved heating demand with the goals of the retrofit (design) the building DK shows the best results, as the monitored heating demand in two periods was almost on the predicted level. In almost all other buildings the monitored demand was above the design values. Exceptions are GER02 and GER03 (in the third year of operation as described before). The reduction in delivered heating demand is basically due to building insulation measures and the utilization of energy efficient technologies (e.g. heat recovery, more efficient heat generators like heat

pumps). The reduction in primary energy for heating purposes is furthermore due to a switch to energy carriers with lower primary energy factors, e.g. in in GER03 from gas to waste heat and the ground as environmental heat source.

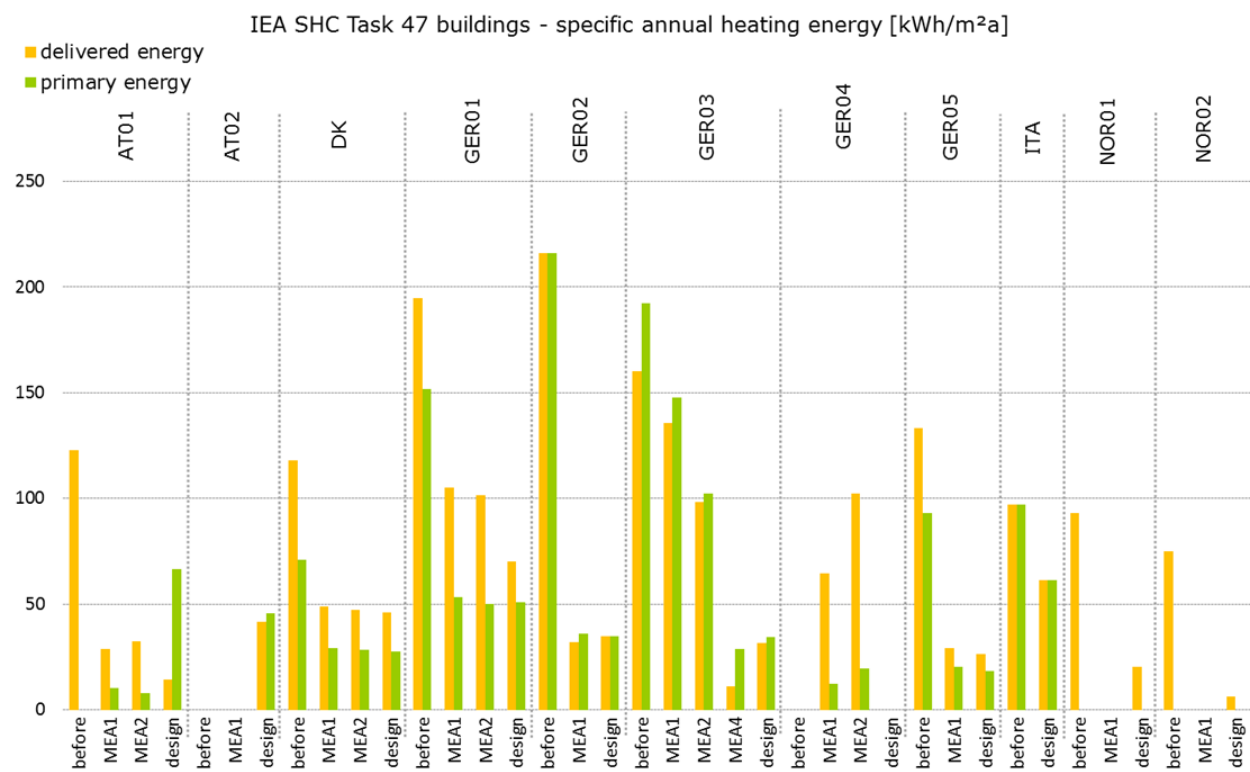

Figure 5: Specific annual primary and delivered heating demand of evaluated and monitored buildings. Before retrofit ("before"), design values ("design") and different years of monitoring and operation ("MEA").

5.3 Cooling Energy Analysis

A detailed analysis is not possible due to the reasons mentioned in the beginning of chapter 5. For the building GER03 monitoring data for two years was provided. The final energy demand for cooling in these years was between 4.6 and 5.9 kWh_{el}/(m²*a) supplying 10 and 20 kWh_{th}/(m²*a) useful cooling energy. In the case study building ITA there was no mechanical cooling before the retrofit. With the retrofit measures mechanical and solar cooling devices were installed which results in an electrical energy demand for cooling purposes (design) of 16.5 kWh_{el}/(m²*a). In the buildings NOW01 and NOR02 the aim of the retrofit measures was to reduce the electricity demand for cooling significantly. In NOR01 the aim is to reduce the demand from 15.1 to 5.4 kWh_{el}/(m²*a) and the useful cooling energy demand from 25.2 to 7.0 kWh_{th}/(m²*a). In NOR02 electricity demand for cooling will be reduced from 40 to 2.1 kWh_{el}/(m²*a) and the useful cooling energy demand from 33.6 to 18.7 kWh_{th}/(m²*a). For both buildings no monitoring data is available. As a consequence, the performance and target achievement cannot be evaluated and discussed.

5.4 Comparison of energy performance before and after the retrofit

Of main interest for all retrofit projects is whether the energy saving goals were achieved or not. In Figure 6 the delivered energy demand as well as the achieved and the planned energy savings are plotted. In two buildings, namely GER02 and GER05, the achieved savings were slightly higher than planned; 85 % instead of 83% and 80 % instead of 78 % respectively. The highest savings were achieved in the buildings GER02, GER03 and GER05 (GER02 and GER05 also have the lowest specific energy demand of all buildings, of which monitoring data is available, which is mainly due to good insulation and the overall switch from very old building service technologies to highly efficient ones); all buildings, which use heat pumps or at least the ground for the preheating of supply air and low-temperature heat distribution systems.

In addition, efficient heat recovery systems and other innovative heat sources like waste heat or the return flow of the district heating are used. The lowest savings in delivered energy demand were achieved in GER01. In the buildings AT01, DK, GER01 and GER03 the end energy demand is above the design. In most of these buildings the difference between the design and the actual energy demand was reduced during the monitoring with the highest success in GER03. The high improvement in GER03 is due to the finalization of the retrofit between MEA2 and MEA4 and a continuous optimization of the building services. In GER04 statements about the achieved savings are impossible as energy consumption data from the time before the retrofit is missing. But it can be seen that the energy demand is below the calculated demand in both monitoring periods. In all other buildings no monitoring data for an evaluation of the savings and the target achievement is available.

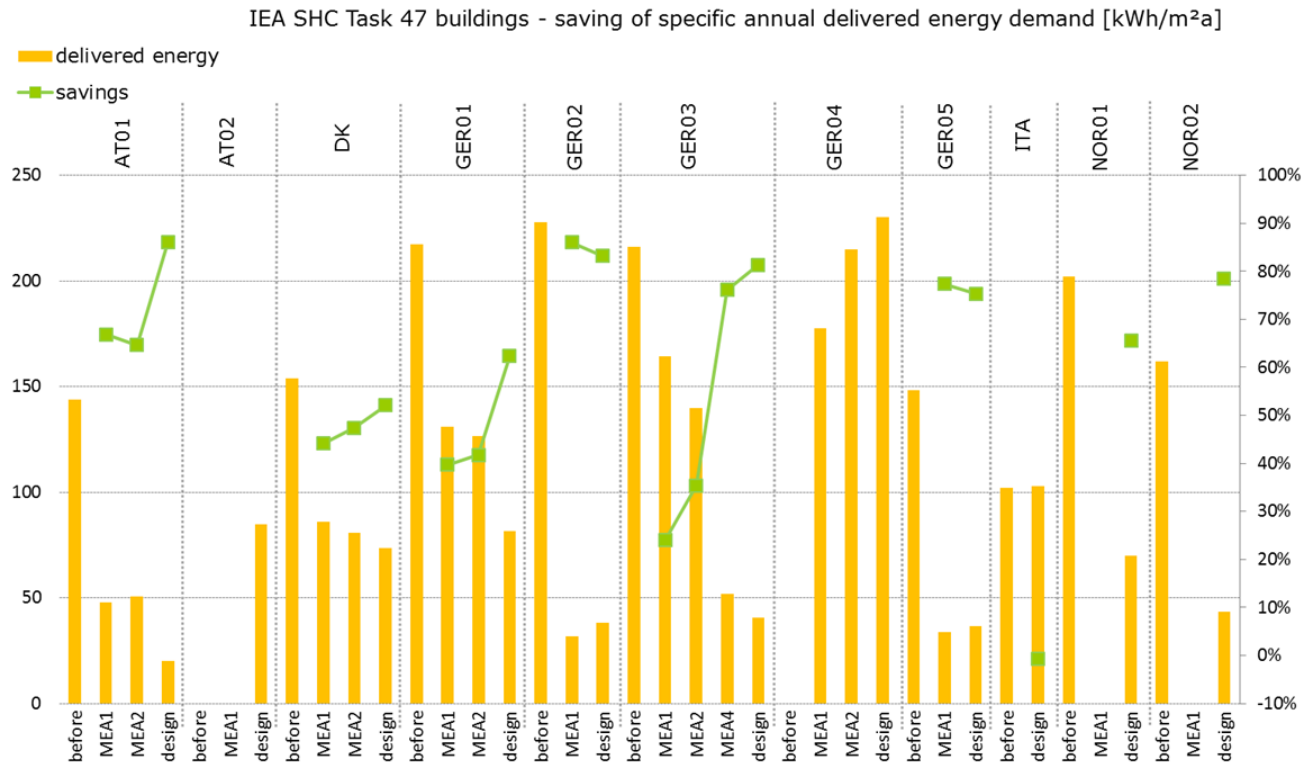

Figure 6: Specific annual delivered energy demand and realized savings of evaluated and monitored buildings. Before retrofit ("before"), design values ("design") and different years of monitoring and operation ("MEA").

In Figure 7 the primary energy demand and the energy savings are plotted. Like the end energy demand, also the primary energy demand during the monitoring periods is below the target value in GER04. Due to missing data no statement about the savings compared to pre-renovation is possible. In almost all other buildings the primary energy demand and the achieved savings in primary energy demand show the same tendency as the developments and targets of the end energy demand. In GER02 and GER05 the achieved savings are higher than the targets. The percentage savings are slightly lower than the percentage savings in delivered energy demand, which in GER05 is mainly due to the fact that the new heat supply system(s) use electricity, which as a higher primary energy factor than e.g. gas or biomass. The same effect can be seen in the building GER03, in which the achieved savings in primary energy are slightly below the savings in delivered energy.

In most buildings (excluding GER02 and GER05) the achieved savings are below the target value, but with an increase during the monitoring periods. An exception is the building AT01. While the end energy demand target was not achieved, the actual primary energy demand exceeded the targets, but it has to be mentioned that the available data for the primary energy demand does not include the primary energy demand for the preparation of drinking hot water. In the building AT02 monitoring data is not available, but the target is to reduce primary energy demand by 65 %. The building ITA has an increasing primary energy demand. As mentioned above, the reason for the increase is the installation of mechanical cooling devices, which are partly operated with electricity and electricity has a high primary energy factor.

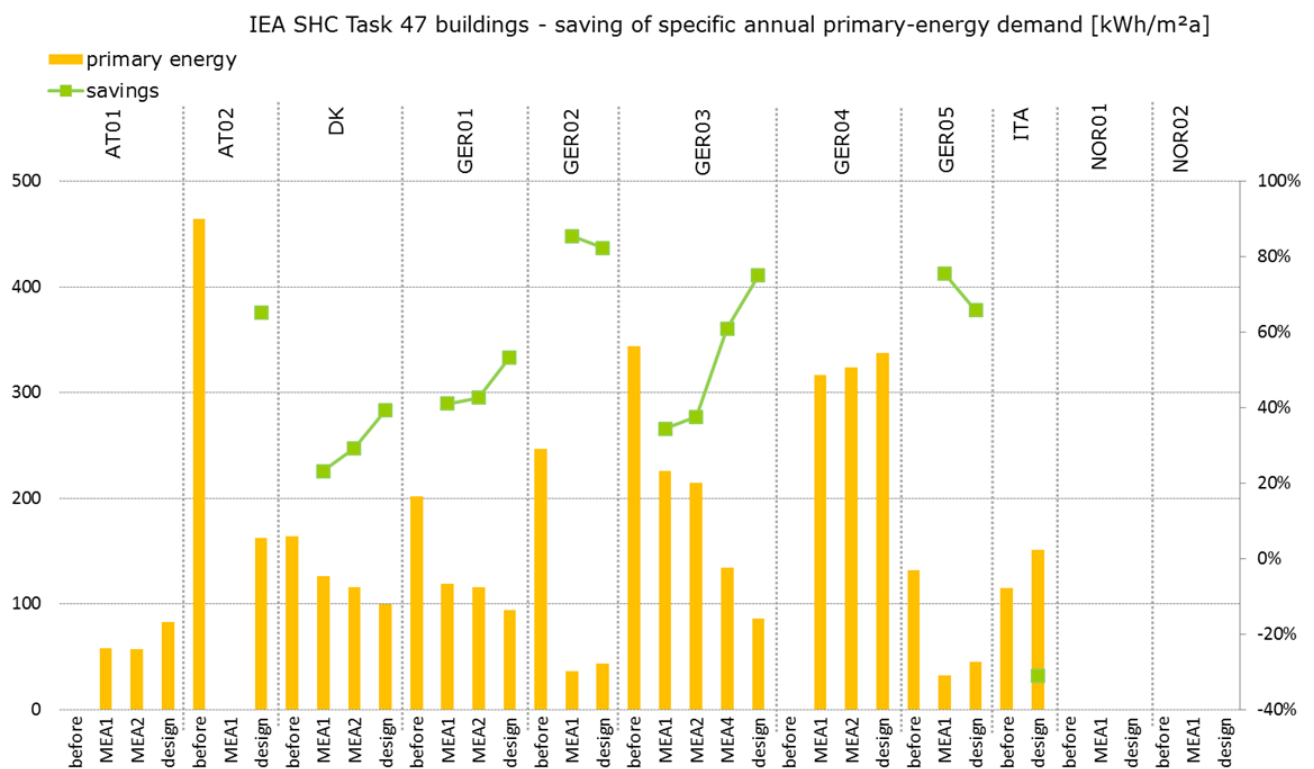

Figure 7: Specific annual primary energy demand and realized savings of evaluated and monitored buildings. Before retrofit ("before"), design values ("design") and different years of monitoring and operation ("MEA").

5.5 Comparison of energy performance of demonstration buildings with national databases

5.5.1 Germany

The German building regulation (*“Verordnung über energiesparenden Wärmeschutz und energiesparende Anlagentechnik bei Gebäuden (Energieeinsparverordnung – EnEV)”*) [9], in the following referred to as EnEV, from 2007, last revised on 18th November 2013 sets requirements for the building envelope as well as the building services and the maximum primary energy consumption for all building types, both for new and refurbished buildings. The maximum primary energy demand is set by the calculation of the demand of a reference building with the same geometry and orientation as the building to be built or refurbished according to defined procedures based on national standards (for non-residential buildings the standard is DIN V 18599). The maximum primary energy demand of new built non-residential buildings will be reduced by 25 % on 1st January 2016. For new built non-residential buildings (NRBs) and a reference building, which has to be used to classify the calculated energy demand, the requirements are set in Appendix 2 of the EnEV. For the refurbishment of non-residential buildings, the requirement is that the yearly primary energy demand and the maximum values of the mean thermal transmission coefficients of the heat-transferring envelope area for new built NRBs are not exceeded more than 40%. Table 9 lists the most important requirements (typical building elements, energy demand) of new built and refurbished NRBs.

Table 9: Requirements for new built and refurbished non-residential buildings according to EnEV [9].

Elements/ Systems	Level of performance	Maximum value new built		Maximum value refurbishment	
		Set room temperature for heating $\geq 19\text{ }^{\circ}\text{C}$	Set room temperature for heating 12 to $< 19\text{ }^{\circ}\text{C}$	Set room temperature for heating $\geq 19\text{ }^{\circ}\text{C}$	Set room temperature for heating 12 to $< 19\text{ }^{\circ}\text{C}$
Opaque external envelope elements excl. curtain walls, glazed roofs, window strips, dome light (thermal transmission coefficient)	EnEV 2009	0.35 W/(m ² K)	0.50 W/(m ² K)	0.49 W/(m ² K)	0.70 W/(m ² K)
	New built until 31 st December 2015	0.35 W/(m ² K)			
	New built after 1 st January 2016	0.28 W/(m ² K)			
Transparent external envelope elements excl. curtain walls, glazed roofs, window strips, dome light (thermal transmission coefficient)	EnEV 2009	1.90 W/(m ² K)	2.80 W/(m ² K)	2.66 W/(m ² K)	3.92 W/(m ² K)
	New built until 31 st December 2015	1.90 W/(m ² K)			
	New built after 1 st January 2016	1.50 W/(m ² K)			

Curtain walls	EnEV 2009	1.90 W/(m ² K)	3.00 W/(m ² K)	2.66 W/(m ² K)	4.20 W/(m ² K)
	New built until 31 st December 2015	1.90 W/(m ² K)			
	New built after 1 st January 2016	1.50 W/(m ² K)			
Glazed roofs, window strips, dome light	EnEV 2009	3.10 W/(m ² K)	3.10 W/(m ² K)	4.34 W/(m ² K)	4.34 W/(m ² K)
	New built until 31 st December 2015	3.10 W/(m ² K)			
	New built after 1 st January 2016	2.50 W/(m ² K)			

The requirements do not have to be met, when less than 10% of the area of an envelope element is changed/ refurbished.

A further measure to increase the energy efficiency of buildings is the mandatory replacement of old heating boilers. In the new EnEV from 2014 requirements for the replacement are defined. If a building is used by the owner, boilers built before 1st October 1978 are not allowed to be operated anymore. Heating boilers built before 1st January 1985 have to be put out of service before 1st January 2015. Exceptions are low-temperature and condensing boilers as well as boilers with a thermal power below 4 kW_{th} and above 400 kW_{th}. Generally, it is only allowed to operate a boiler for maximum 30 years.

The European building directive was update and changed several times since it came into effect. Amongst others, it sets standards for the energy efficiency of buildings and forced member states to develop benchmarks for the energy efficiency of buildings, which are used for the energetic classification in Energy Performance Certificates. In the research project "Benchmarks für die Energieeffizienz von Nichtwohngebäuden" [13] energy demand data from non-residential buildings in Germany was analysed and a table listing typical heat and electricity demands of different types of non-residential buildings was developed for the energetic classification. In Table 10 the energy demand data from the German demonstration buildings is compared with the national benchmarks developed in [13]. It has to be mentioned that there are no exact equivalents for the buildings GER01, GER03 and GER04 in [13]; therefor the data from these buildings can only be compared partially with the benchmarks.

It can be seen Table 10 that the heat and electricity demand of all demonstration buildings is below the benchmarks for Germany; the heat demand is between 40 and up to 90% lower than the benchmarks of existing non-residential buildings and the electricity demand is between 5 and 80 % lower. It has to be mentioned that the high heat demand from GER03 of 136 kWh_{th}/(m²a) was monitored in the first year of monitoring before the building services were optimized and the renovation was completed. After the finalization of the project the heat demand was around 11 kWh_{th}/(m²a). Furthermore, in the building GER04 the electricity demand includes the consumption of the workshops in the building. There are no separate meters installed for the office and the workshop zones of the building. The electricity demand for the operation of the building and the offices is most likely fa below the 113 kWh_{el}/(m²a).

Table 10: Benchmarks of specific delivered energy demand of non-residential buildings in Germany from [13] compared with the values (band width of monitoring and design data) of the demonstration buildings in Germany.

Building type	Abbreviation	Reference value heat	Reference value elec- tricity	Monitored value heat	Monitored value elec- tricity
		kWh _{tr} /(m ² a)	kWh _{el} /(m ² a)	kWh _{tr} /(m ² a)	kWh _{el} /(m ² a)
School	GER02, GER05	140	20	GER02: 32 – 35 GER05: 26 – 29	GER02: 3.4 GER05: 5 – 10
Kindergarten ¹	GER01	160	25	70 – 105	12 – 26
Office and workshop	GER03, GER04	Institute building: 145 Office building: 160	Institute building: 70 Office building: 120	GER03: 11 – 136 GER04: 65 – 102	GER03: 9 – 42 GER04: 113

Summing up, all demonstration buildings in Germany do comply with the latest German building regulation (even with the standards for new built buildings), even though the buildings were refurbished before the building regulation from 2014 came into force. Furthermore, the energy demand of all buildings is below the national benchmarks for both, heat and electricity.

5.5.2 Denmark

The Danish Building Regulations 2010 (BR10) tightened the energy performance requirements for individual building components for all building types. This rule applies to the replacement or major renovation of a component. However, the measures must be economically feasible. This means that the annual savings multiplied by the expected lifetime of the measure divided by the investment should be higher than 1.33 or, put another way, the measure must have a simple payback time of less than 75% of the expected lifetime of the measure. In case of full replacement of a component (e.g., a new roof, new window, new outer wall), the new component must meet the requirements set in the BR10, regardless of profitability.

For existing buildings, the requirements were initially implemented according to the definition of the 25% cost rule in the EPBD (though no area threshold was implemented), in combination with component requirements. According to the earlier Danish Building Regulation, all cost-effective measures had to be implemented if more than 25% of the building envelope or the value of the building were affected. However, studies regarding the impact of this rule on the implementation of energy saving measures showed that the rule was a hindrance to energy savings. It was therefore decided to increase the uptake of energy saving measures in the existing building stock, by implementing more strict requirements for the replacement or renovation of the individual components. The BR10 contains a list of the minimum requirements; most of these are considered economically profitable under normal conditions. However, the requirements for the replacement of windows must be fulfilled without consideration of the economic aspects.

¹ As there is no *Kindergarten* in the reference list the values from *day-care center* were taken.

Table 11: U-values and cold bridges requirements – examples.

All existing buildings	Changed use and extensions	Pavilions	Single component requirements	Secondary homes	Maximum requirements, new buildings
U-value requirements [W/m ² K]					
External walls and basement walls towards ground	0.15	0.20	0.20	0.25	0.30
Slab on ground etc.	0.10	0.12	0.12	0.15	0.20
Loft and roof constructions	0.10	0.15	0.15	0.15	0.20
Windows	1.40	1.50	1.65 (doors)	1.80	-
Roof windows	1.70	1.80	1.65	1.80	1.80
Cold bridges [W/(m K)]					
Foundations	0.12	0.20	0.12	0.15	0.20
Joints between windows and walls	0.03	0.03	0.03	0.03	0.06
Minimum energy gain [kWh/m ² year]					
Facade windows	-	-	-33	-	-33

The energy performance requirements for *new* buildings were implemented in their current form, i.e. the energy performance calculation method, in 2006, after the implementation of the first EPBD. These requirements included forecasts for the tightening of the EP requirements in 2010 and 2015 – approximately 25% compared with the 2006 requirements in each step. In 2009, the requirements were revised, and the EP requirements for new buildings were tightened by 25% in the Danish Building Regulations 2010 (BR10).

Table 12: Development of EP requirements for new buildings (kWh primary energy per m² of heated gross floor area per year) for typically sized residential and non-residential buildings. Requirements are area-dependent in 2006, 2010 and 2015 but not in 2020.

	2006	2010	2015	2020
Residential, 150 m ² of heated gross floor area	84.7	63.0	36.7	20.0
Non-residential, 1000 m ² of heated gross floor area	97.2	73.0	42.0	25.0

5.5.3 Austria

Energy performance requirements for new built and renovated buildings in Austria are set by the OIB Guideline 6 on 'Energy saving and heat insulation', from the OIB – Österreichisches Institut für Bautechnik / Austrian Institute of Construction Engineering, last revision from October 2011. The following U-values are set for the renewal of building parts and for new built and renovated buildings and must not be surpassed for conditioned rooms:

Building element	U-Value [W/m²K]
Walls against ambient air temperature	0.35
Walls against unheated attic	0.35
Walls against unheated building parts that must be kept frost-free (except attic) as well as against garages	0.60
Walls against ground	0.40
Walls separating residential or non-residential utilisation units	0.90
Walls against other buildings at the property boundary	0.50
Walls small sized against outside air (e.g. dormers) that remain within the limits of below 2 % of the total walls against outside air, as far as Ö-NORM B 8110-2 (occurrence of condensate) is considered	0.70
Walls (partition walls) within residential or non-residential buildings	-
Windows, glazed doors in residential buildings against ambient air temperature ²	1.40
Windows, glazed doors in non-residential buildings against ambient air temperature ¹	1.70
Other transparent vertical building parts against ambient air temperature 2	1.70
Other transparent building parts against ambient air temperature, horizontal or declined 2	2.00
Other transparent vertical building parts against unheated parts of the building 1	2.50
Window roofs against ambient air temperature 2	1.70
Doors, unglazed, against ambient air temperature 2	1.70
Doors, unglazed against unheated parts of the building 2	2.50
Gates, rolling doors, sectional door and similar against ambient air temperature	2.50
Doors inside	-
Ceilings and pitched roof areas against ambient air temperature and against attic rooms (naturally ventilated or not insulated)	0.20
Ceilings against unheated parts of the building	0.40
Ceilings against separated residential or non-residential units	0.90
Ceilings within residential or non-residential units	-

Building element	U-Value [W/m ² K]
Ceilings as limitation against ambient air temperature (e.g. passages, parking decks)	0.20
Ceilings against garages	0.30
Floors against ground	0.40

1 The construction has to be referenced to a check gauge of 1.23 m x 1.48 m.

2 With reference to a standardized check gauge of 1.23 x 1.40 m.

The Austrian initiative klimaaktiv Building and Refurbishment has established the klimaaktiv building standard in Austria as a benchmark for ecological buildings. It is not only energy efficiency that is assessed and evaluated in klimaaktiv buildings, but also the quality of planning and execution, the building material and construction quality as well as the core aspects of comfort and indoor air quality. The klimaaktiv building standard exists for residential and office buildings, for new buildings and for renovated buildings. The basic criteria were formulated in the year 2011. Specific klimaaktiv standards are available since the end of 2011 for hotels, schools, nursery schools and nursing homes to enable even more targeted promotion in the sector of service buildings. All criteria catalogues are structured along the lines of a 1,000 point system which is used to assess the buildings and declare their compliance. The catalogues are available in German and can be found at <http://www.klimaaktiv.at/bauen-sanieren/gebaeuedeklaration/kriterienkatalog.html>

One goal is the reduction of the heating energy demand, as a major mean to bring down the use of energy and greenhouse gas emissions. It is measured as 'specific space heating demand', called HWB*V,NWGsan,RK, in [kWh/m³a] following OIB Guideline 6 as well as national standards. The value describes the required thermal energy per conditioned brutto volume that a building needs at reference climate and over the period of a year, to keep the indoor temperature at 20°C. The assessments of residential buildings and non-residential buildings are based on the use type "residential" to keep the evaluation results comparable.

klimaaktiv sets the minimum requirements of the heating energy demand for the renovation of office buildings as follows:

- HWB*V,NWGsan,RK 22,313 kWh/m³a for buildings with an A/V ratio of 1,0 and higher
- HWB*V,NWGsan,RK 9,56 kWh/m³a for buildings with an A/V ratio of 0,2 and lower

Intermediate values are calculated with linear interpolation.

6 Comfort Analysis

Doreen Kalz, Fraunhofer ISE
Benjamin Köhler, Fraunhofer ISE

The indoor comfort of each building with available hourly room temperatures is analyzed and classified according to EN 15251. The graphical evaluation includes comfort scatter plots and comfort footprints.

6.1 Thermal Comfort in Office Buildings

Thermal comfort in non-residential buildings has to be evaluated in accordance with the European standard EN 15251:2007-08 which defines two comfort models based on the cooling concept implemented in the building: the adaptive model and the PMV model.

The standard DIN 15251 formulates unambiguous conditions with the following definition:

Buildings without mechanical cooling devices: *“Buildings without mechanical cooling: buildings that do not have any mechanical cooling and rely on other techniques to reduce high indoor temperature during the warm season like moderately sized windows, adequate sun shielding, use of building mass, natural ventilation, night-ventilation, etc. to prevent overheating.”* Thermal comfort in those buildings has to be in accordance with the requirements described by the adaptive comfort model (see above).

In this context, “mechanical cooling” is defined explicitly and is distinguished from passive cooling methods in terms of the guideline as follows:

Buildings with mechanical cooling devices: *“Cooling of the indoor environment by mechanical means used to provide cooling of supply air, fan-coil units, cooled surfaces, etc. The definition is related to people’s expectations regarding the internal temperature in warm seasons. Opening of windows during day and night time is not regarded as mechanical cooling. Any mechanically assisted ventilation (fans) is regarded as mechanical cooling.”* Thermal comfort in those buildings has to be in accordance with the requirements described by the PMV comfort model (see above). Criteria for the thermal environment shall be based on the thermal comfort indices PMV-PPD as described in detail in EN ISO 7730.

The term “mechanically cooled” encompasses all concepts employing a mechanical device to condition the space, such as supply and/or exhaust air systems, thermo-active building systems, and convectors. Only buildings employing natural ventilation through open windows fall into the category of “non-mechanical” concepts. This method may be applied when certain requirements are met: thermal conditions are primarily regulated by the occupants by operating windows that open to the outdoors. Furthermore, occupants are engaged nearby in sedentary activities and are supposed to feel free to adapt their clothing to thermal conditions.

6.2 Evaluation of thermal comfort

In the following the results and findings from the thermal comfort analysis is presented by building and in a cross comparison. As some of the demonstration buildings (ITA, NOR02) are new and therefore no monitoring data is available for these buildings, they are not discussed below. The comfort analysis is in accordance with EN ISO 15251 as

described in chapter 3.3. The thermal comfort is analyzed with the adaptive comfort model of EN ISO 15251.

AT01: School, Schwanenstadt

During the monitoring period (summer season 2009) thermal comfort with respect to category II was achieved during approximately 96 % (upper boundary), 91 % (lower boundary) and approximately 88 % (total) of occupancy in the demonstration building AT01 (see comfort footprint; lower graph in Figure 8). Comfort category III was violated during about 3% of the occupancy hours. The lower comfort boundary of category II was violated when the running mean of the ambient air temperature (AT) was low (between -4 and 3°C) and for ambient air temperatures between 15 and 20°C. The upper boundary of category II was violated with increasing ambient air temperatures between 10 and 20°C. For ambient temperatures above 20°C the operative room temperatures (ORT) do not increase further and even decrease slightly. For ambient temperatures between 15 and 20°C the operative room temperatures had a wide variation between 20 and 28 °C. One possible reason for this wide spreading is the unsteady operation of heating and cooling devices and a difficult regulation of the devices in the transition periods from spring to summer and summer to autumn.

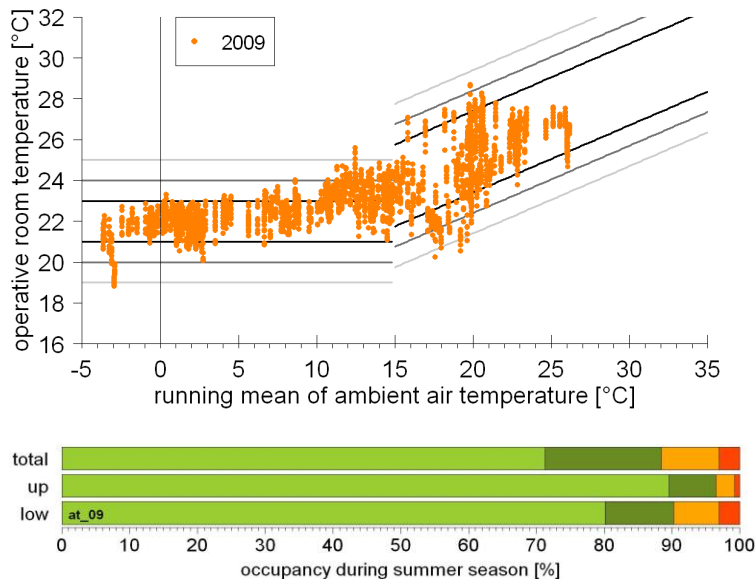

Figure 8: Comfort plot (top) and the thermal comfort footprint (bottom) for the summer season 2009 of AT01.

GER01: School/ Kindergarten, Ulm

The thermal comfort in the demonstration building GER01 was analyzed for the summer season 2006. Thermal comfort with respect to category II was achieved during approximately 100 % (upper boundary) and 96 % (lower boundary and total) as illustrated in the comfort footprint in Figure 9 (lower graph).

For running mean temperatures of the ambient air below 11°C the ORT was relatively constant between 20 and 22°C. For higher ATs the operative room temperature increased steadily. The constant increase is in contrast to the building AT01, in which the ORT stopped increasing for mean ambient temperatures above 20°C. One difference between the buildings is that the shading system in GER01 is only manually operated, while it is automated in AT01 depending on the irradiance. Closing shading systems can avoid higher ORTs during summer in non-residential buildings, which was also observed in other monitoring projects at Fraunhofer ISE.

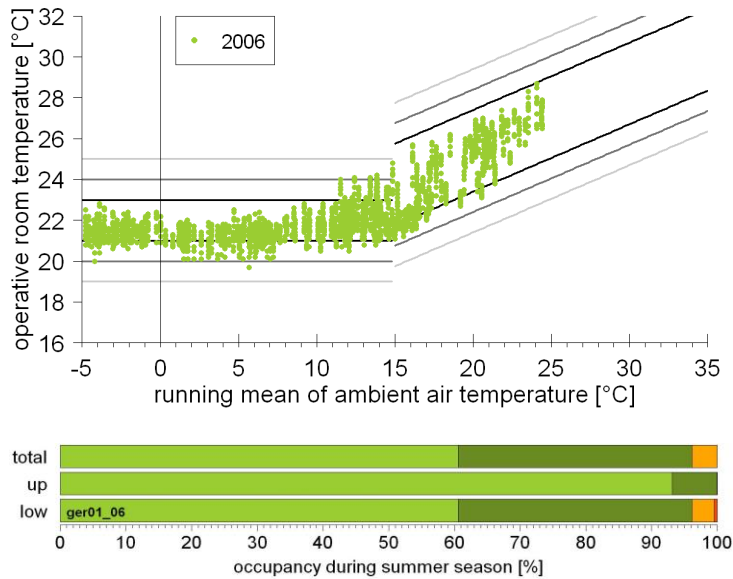

Figure 9: Comfort plot (top) and the thermal comfort footprint (bottom) for the summer season 2006 of GER01.

GER02: School, Olbersdorf

The thermal comfort in the demonstration building GER02 was analyzed for the summer season 2006. Thermal comfort with respect to category II was achieved during approximately 100 % (upper boundary) and 94 % (lower boundary and total) as illustrated in the comfort footprint in Figure 10 (lower graph).

For a running mean temperature of the ambient air below 15°C the ORT fluctuated between 20.5 and 23°C. For an increasing AT the operative room temperature also increased moderately, but slower than in GER01. Compared with the buildings AT, GER01 and GER03 the school building in Olbersdorf only shows small fluctuation in the operative room temperature of about 2.5 K (compared with 4 to 8 K). For ambient temperatures above 15°C the ORTs did not reach the upper comfort boundary of category I. In contrast to the buildings AT01 and GER01, GER02 is equipped with an efficient ground-coupled cooling system using ceiling suspended cooling panels for the cold transfer leading to comfortable thermal indoor conditions.

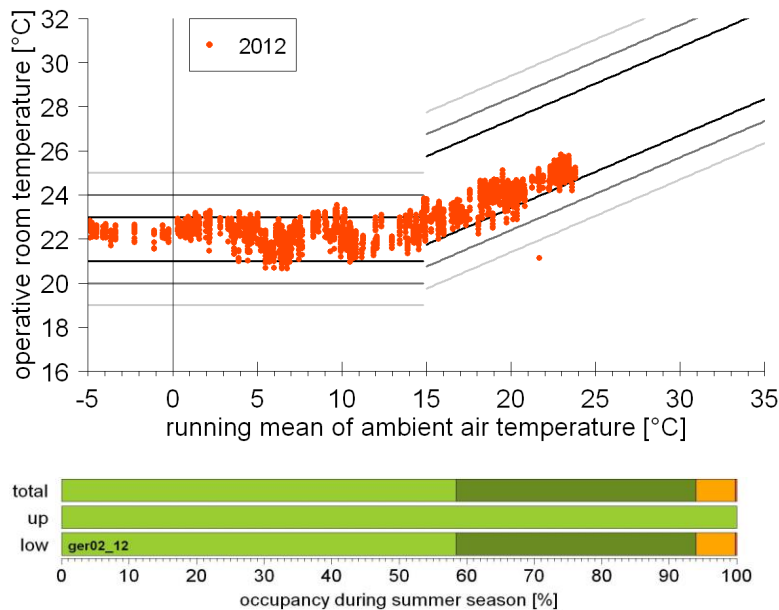

Figure 10: Comfort plot (top) and the thermal comfort footprint (bottom) for the summer season 2012 of GER02.

GER03: Printing workshop and Office Building, Karlsruhe

The thermal comfort in the demonstration building GER03 was analyzed during a period of three years (2008 – 2010). During that time several technical installations were added (like e.g. the heat pump system) and the operation and control of all technical services was continuously optimized. The changes in thermal comfort can be seen in Figure 12.

Thermal comfort with respect to category II was achieved during the percentage of occupancy hours as listed in Table 13 and illustrated in Figure 11 and Figure 12. Concerning the upper comfort boundary the constant improvement in technical equipment and operation between 2008 and 2010 can be clearly seen, with the largest improvement from 2008 to 2009 (8.5 percentage points). From 2008 to 2009 a small improvement related to the lower comfort boundary can be seen, but in 2010 the lower comfort boundary of category II was valuated during more than 20 % of the occupancy hours indicating that the operative room temperature during summer in the building GER03 decreased sharply in 2010 compared with the years before.

Table 13: Percentage of time in which comfort category II is achieved during occupancy in 2008, 2009 and 2010 divided by upper and lower comfort boundary as well as the sum both boundaries (total).

Comfort boundaries	2008	2009	2010
Total	84%	-	-
Up	88.5%	97%	98%
low	97%	98%	79.5%

In all monitoring years plotted below, the operative room temperatures show high fluctuations for all ambient temperatures. Compared with the other demonstration buildings analyzed in this chapter GER03 has the highest ORT-fluctuations. For higher ATs above 15°C, the ORT-fluctuation and the ORT-level also increase. Figure 11 on the one hand shows the comparatively high fluctuations, but it also shows that the temperature differ-

ences between very low and high ATs decreased between 2008 and 2010 from approximately 13 to 11.5 K.

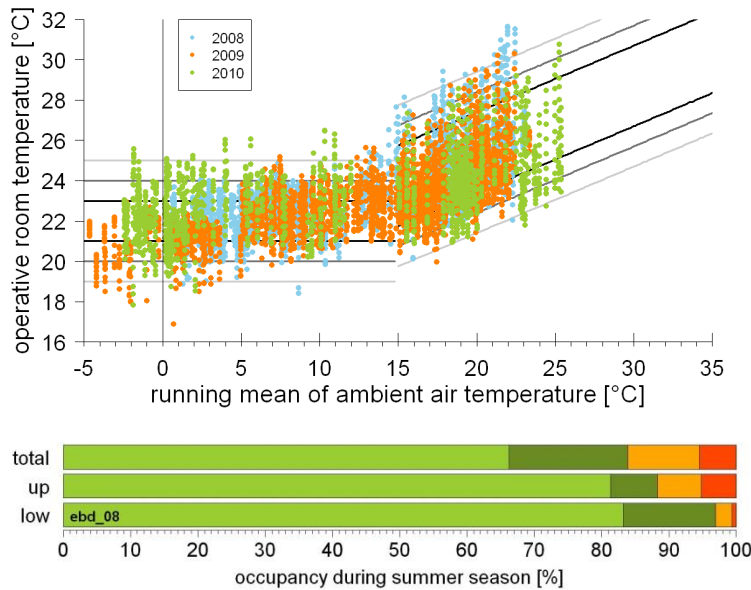

Figure 11: Comfort plot for the summer seasons 2008, 2009 and 2010 (top) and the thermal comfort footprint (bottom) for the summer season 2008 of GER03.

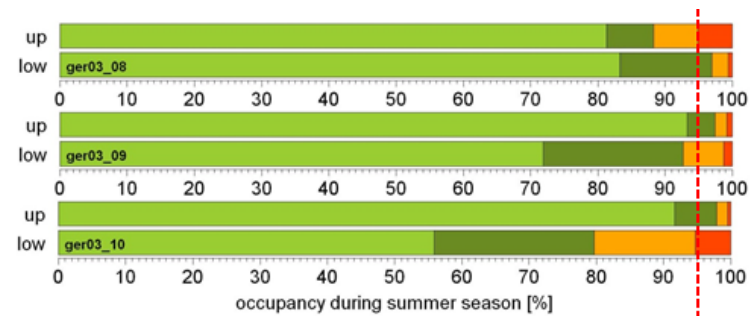

Figure 12: Comfort footprints of the demonstration building GER03 for the years 2008 – 2010. The dotted red line indicates the time in which the comfort boundaries of EN 15251 have to be met (during 95% of occupancy hours, see chapter 3.3).

Comparison of demonstration buildings

In the following four demonstration buildings are compared, from which three are situated in Germany, and one in Austria. In Figure 13 the comfort footprints of the monitored summer seasons are plotted and in Figure 14 the footprints of the winter seasons. The dotted red lines indicate the time in which the comfort boundaries of EN 15251 have to be met (during 95% of occupancy hours, see chapter 3.3).

During summer seasons, the upper comfort boundary of category II is met in all buildings, with the exception that the thermal comfort requirement was not met in the first monitoring year (2008) in the building GER03 (explanations see above). While the upper comfort boundaries are met by all buildings, the lower boundaries are violated more often, especially in the building GER03 in 2010 and in AT01 (in the graphs below AT_09 with 09 indicating the year of monitoring). The cooling concepts of all buildings manage to avoid elevated operative room temperatures, but also lead to relatively low ORTs in relation to the ambient temperatures, which can lead to uncomfortable conditions on very warm days as well.

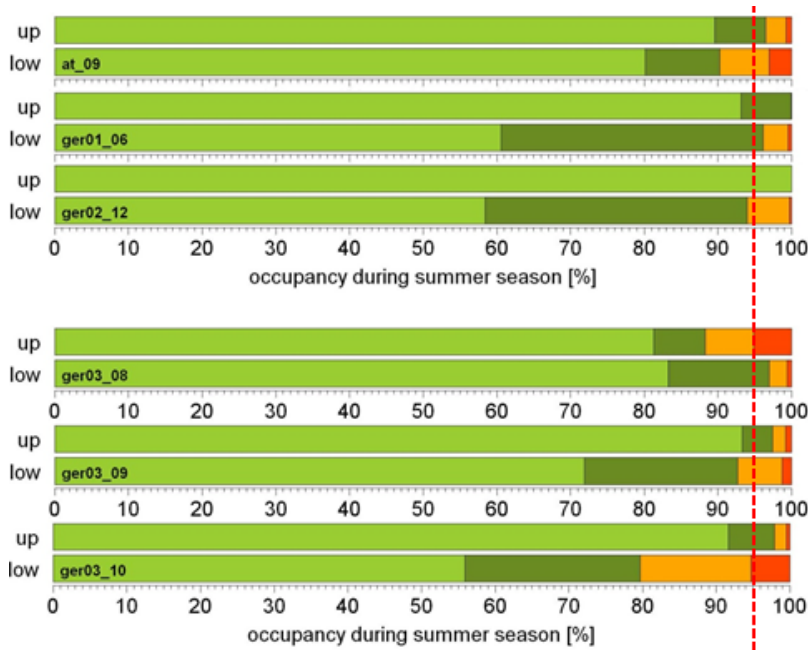

Figure 13: Thermal comfort footprint of AT01, GER01 and GER03 for summer seasons.

During the heating/winter season, the thermal comfort in the buildings differs strongly from the comfort conditions in summer. In the buildings GER01 (during 98 % of occupancy hours comfort requirements are met), GER02 (during 89% requirements met) and in the last monitoring year in GER03 (during 75% requirements met) the upper comfort boundary of category II was violated more often than the lower boundary. In all other cases the lower comfort boundary was violated more often leading to an acceptable thermal comfort during 97% in GER01 and 84% in 2008 and 92% in 2009 in GER03 of the occupancy hours. In most cases the violations exceed the acceptable 5% of the occupancy hours (in GER03 during 17% in 2008, 8% in 2009 and approx. 25% in 2010, in GER02 during 11% and in AT01 17% of occupancy hours).

In the buildings in which the lower comfort boundaries are violated more often than the upper boundaries, an acceptable thermal comfort is achieved during 94% in GER01 and 69% in 2008 and 77% in 2009 in GER03 of the occupancy hours (lower boundary of category II). In the other buildings/ monitoring periods thermal comfort is achieved in 97% (AT01), 95% (GER02) and 93% (GER03, 2010) of the occupancy hours.

In conclusion, the lower and the upper comfort boundary of category II, are violated during more occupancy hours in winter than in summer. One possible reason is the night set-back of the heating system leads to lower temperatures in the morning hours and the thermal inertia of the building masses. Both effects have a positive influence on the thermal comfort in summer when lower temperatures are desirable, but a negative effect in the winter, when the aim is to keep heat losses low and avoid too strong cooling of buildings during the nights and weekends.

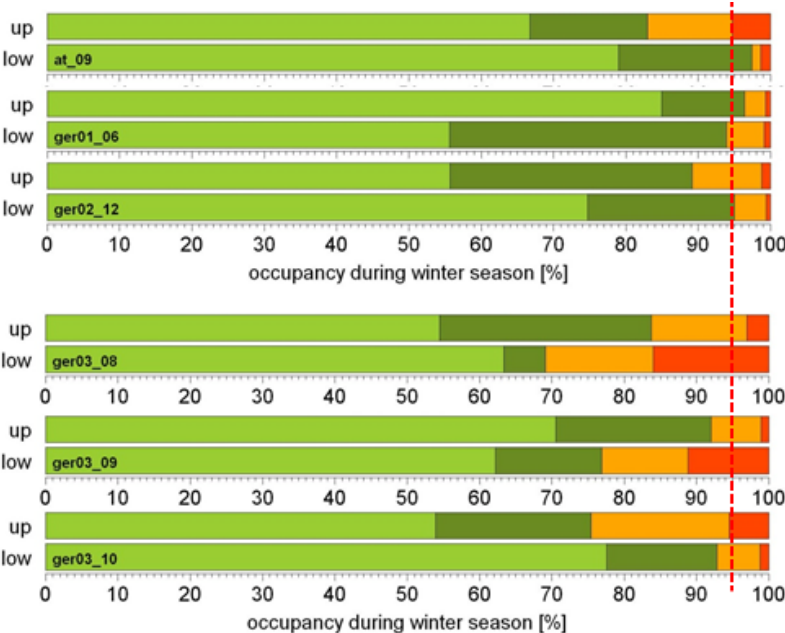

Figure 14: Thermal comfort footprint of AT01, GER01 and GER03 for winter seasons.

7 Cross-comparison of Daylighting

Roman Jakobiak, Daylighting

7.1 Selection of the Case Studies

Within the IEA Task 47 case studies are subject of Subtask A: "Advanced Exemplary Projects" and Subtask C: "Assessment of Technical Solutions and Operational Management". Subtask A focuses on the documentation and analysis of the overall renovation, while Subtask C refers in particular to the systems of space conditioning.

In order to analyze the heating, ventilation and air conditioning systems and lighting in Subtask C, detailed information about building systems is needed while the case study description in Subtask A is more general. In addition to the description of the systems Subtask C requires monitoring data as well. The original plan was to gather the necessary data for analysis by a form, in which the participants in the task fill in their case studies. Since the participants in Task 47 did not preprocess the data of their case studies to the extent required and did not fill in the form provided, this plan had to be abandoned. Instead, the case studies descriptions of Subtask A were used for the cross-sectional evaluation of lighting.

Since the PowerPoint presentations in Subtask A contain only part of the information required for the cross-sectional analysis, the data had to be collected for each project individually. In a first step the PowerPoint presentation and other available documents (e.g. research reports) were interpreted and the relevant data were transmitted in the data sheet. Additional information then was requested individually from the authors of the case study.

Not all case studies of Subtask A could be used for the cross-section evaluation. As the evaluation method uses one exemplary space in the building for evaluation, Projects that changed the interior layout significantly could not be considered. In most cases, however, projects could not be evaluated because the necessary information was not available. Table 14 lists the Subtask A case studies and shows which projects have and have not been evaluated for the cross-analysis in lighting.

Table 14: List of the cases studies that have been included / not included in the cross-section evaluation regarding lighting.

Building	Status
AT, Bruck/Mur, Administration building	✓
AT, Graz, Monastery	✓
AT, Innsbruck, University building	✗ (lack of information)
AT, Linz; ASO School Renovation	✗ (lack of information)
AT, Schwanenstadt, Schule	✓
AT, Vienna, Plus-energy-University-building	✗ (lack of information)
AU, Brisbane, 160 Ann Street	✗ (lack of information)

Building	Status
AU, Sydney, 388-George-street	✘ (lack of information)
BE, Brussels, Forest_OCMW	✓
BE, Brussels, Riva-Bella-School	✘ (lack of information)
BE, Brussels, Science-Montoyer office Building	✘ (lack of information)
DE, Cottbus, 3l-school	✘ (lack of information)
DE, Freiburg, Office and workshop building	✘ (not eligible)
DE, Olbersdorf special school	✓
DE, Ulm, Kindergarten	✓
DK, Høje-Taastrup, Kindergarten Vejtoften	✓
DK, Roskilde, Rockwool Office Building	✘ (lack of information)
IT, Cesena, School	✓
IT, Padova, Schueco-HQ	✘ (not eligible)
NO, Asker, Solbråveien Office center	✘ (lack of information)
NO, Oslo, Kampen-skole	✓
NO, Oslo, Norwegian Tax Authority,	✘ (lack of information)
NO, Oslo, NVE building	✘ (lack of information)
NO, Oslo; Powerhouse - Sandvika	✓

The selection of the analyzed case studies thus follows directly from the case studies in Subtask A. Those case studies were used in which the floor plan has not fundamentally changed in the renovation and for which sufficient information was available for evaluation. A total of 10 case studies were evaluated.

7.2 Results

7.2.1 Daylighting

Table 15 shows the effective window to floor area ratio before and after renovation. In 9 out of 10 case studies, the effective window to floor area ratio has decreased by renovating. No. 10 (Powerhouse, Oslo) is a special case, as the depth of the space was reduced, so that the window area refers to a smaller floor area after renovation.

In the other 9 cases occurred with the refurbishment a reduction of the ratio of the effective window area to the floor area between 16% and 50%. Thus occurred in all cases in which the facade has been exchanged or the windows were renewed and in which the floor layout did not change, a decrease of the effective window area.

Table 15: Effective window area to floor area ratio before and after renovation.

	Building	Floor	Room-type	Room id	$A_{\text{eff-Win}}/A_{\text{Floor}}$	$A_{\text{eff-Win}}/A_{\text{Floor}}$	$A_{\text{eff-Win}}/A_{\text{Floor}}$
					before	after	change
1.	AT_Bruck_Admin-building	3	office	2.20	0,12	0,06	-50%
2.	AT_Graz_Franziskanerkloster	3	living room	10	0,03	0,03	-12%
3.	AT_Schwanenstadt_Schule	2	classroom	4	0,10	0,08	-25%
4.	BE_Brussels_Forest_OCMW	2	office	2	0,17	0,13	-24%
5.	DE_Olbersdorf_OS0	3	classroom	310	0,06	0,05	-18%
6.	DE_Ulm_Kindergarten	1	group room	1	0,24	0,20	-16%
7.	DK_Copenhagen_Kindergarten	1	group room	19	0,10	0,08	-19%
8.	IT_Cesena_school	2	classroom	-	0,11	0,08	-24%
9.	NO_Oslo_Kampen-skole	2	classroom	-	0,13	0,11	-16%
10.	NO_Oslo_Powerhouse	3	office	-	0,10	0,13	+26%

To study the cause of the change in the ratio of the effective window area to the floor area in more detail, the changes in the influencing variables that occurred with renovation are shown in Table 16. The effect of the factors will be described in the following sections.

Table 16: Change in the reduction factors for calculating the effective window area related to renovation.

	Building	Floor	Room-type	Room id	$A_{\text{Win}}/A_{\text{Floor}}$	frame	$A_{\text{Glass}}/A_{\text{Floor}}$	τ_v	dirt	well	$A_{\text{eff-Win}}/A_{\text{Floor}}$
					change	change	change	change	change	change	
1.	AT_Bruck_Admin-building	3	office	2.20	-52%	+36%	-35%	-21%	0%	-2%	-50%
2.	AT_Graz_Franziskanerkloster	3	living room	10	0%	+3%	+3%	-12%	0%	-3%	-12%
3.	AT_Schwanenstadt_Schule	2	classroom	4	0%	0%	0%	-20%	0%	-6%	-25%
4.	BE_Brussels_Forest_OCMW	2	office	2	+9%	0%	+9%	-22%	-5%	-5%	-24%
5.	DE_Olbersdorf_OS0	3	classroom	310	0%	-9%	-9%	-9%	0%	-1%	-18%
6.	DE_Ulm_Kindergarten	1	group room	1	0%	0%	0%	-15%	0%	-2%	-16%
7.	DK_Copenhagen_Kindergarten	1	group room	19	0%	0%	0%	-18%	0%	-2%	-19%
8.	IT_Cesena_school	2	classroom	-	0%	-6%	-6%	-18%	0%	-2%	-24%
9.	NO_Oslo_Kampen-skole	2	classroom	-	0%	0%	0%	-16%	0%	0%	-16%
10.	NO_Oslo_Powerhouse	3	office	-	+48%	0%	+48%	-12%	0%	-4%	+26%

7.2.1.1 Window area/ floor area

The window to floor area ratio was changed with the renovation in three projects. In no. 1 (Office building in Bruck) the existing façade was completely replaced by a new façade. The window area of the selected space after renovation was significantly lower than before renovation. In addition, the position of partition walls was changed and the floor area of the selected space therefore was larger by 14%, as before the renovation. In no. 4 (Forestry Commission in Brussels) and in no. 10 (Power House in Oslo) the floor area of the selected space changed. In no. 4, a new façade layer has been introduced between the existing façade on the inside. This led to a slight reduction of the depth of the space. Therefore the unchanged window area referred to a slightly smaller floor area after renovation. In no. 10 the office spaces located at the façade have been considerably reduced in depth and the window area has been increased by 11%. This results in a significantly higher ratio of the window to floor area ratio after renovation. In the other case studies, the window area and floor area of the selected space remained unchanged in renovation. A change in the window area to floor area ratio thus occurred only when either the façade was exchanged, or the floor area of the selected space was changed with the renovation.

7.2.1.2 Window frame

For four case studies the available information allowed a determination of the reduction factor for frames before and after renovation. Example no. 8. (school in Cesena) and no. 5 (Olbersdorfer school) showed an increase in the proportion of frames. In both cases the improvement of the thermal insulation capacity of the window was associated with a thicker frame profile. In no. 2 (Franciscan monastery, Graz) the situation is similar, but through optimization measures it could be achieved, that the portion of glazing bars was slightly smaller after renovation.

Striking is no. 1 (Office building in Bruck), in which the frame portion after renovation was significantly lower. The reason for this lies in the larger sizes of glass panes of the new facade, which have a much lower portion of glazing bars with respect to the small-sized window division of the building before renovation. The four case studies in which the effect of the change in the frame component could be determined show the importance of this factor.

7.2.1.3 Light transmission of the glazing

In all cases where the facade has been renovated, the new glazing shows a lower light transmission compared to the situation before renovation. The reduction in light transmission ranges between 9% and 22%. The lowest light loss has no. 5 (Olbersdorfer school). Here in the outer casement of the box type window single glazing with white glass was used to limit the light loss through renovation. In most of the examined case study buildings the number of glass panes in the window increased in the renovation. In most cases double glazing was replaced by triple glazing. In no. 8 (school in Cesena) single glazing was replaced by a double glazing. In addition to the reduction caused by the additional glass pane a low-E coating contributes to reducing the light transmission of the previously usually uncoated glass. A further reduction by solar shading glass did not occur in the investigated cases.

Among the reducing factors defined for the window, the reduction in light transmission through new window glass proves to be a significant factor with regard to the reduction of the daylight level that occurs due to the renovation of the facade.

7.2.1.4 Reduction factor for dirt

The reduction factor for dirt typically is not affected by the renovation. An exception is no. 4 (Forest Service in Brussels). Here an additional facade was installed. Since the additional facade can also pollute, a reduction of 5% in the reduction factors for dirt resulted.

7.2.1.5 Wall thickness

Due to the application of a thermal insulation or a new facade on the construction of the existing wall, the renovation of the building envelope usually leads to an increase in the wall thickness. With unchanged window size, this results in an increase in the well effect of the window opening and thus a reduction in light transmission of the window system. At 6%, this reduction in no. 3. (School in Schwanenstadt) is greatest. Here a new facade was mounted in front of the existing building shell so that the thickness of the wall rose from 25 cm to 81.5 cm. In no. 4 (Forestry Commission in Brussels) with a reduction of 5%, and in no. 10 (Powerhouse, Oslo) with a reduction of 4% a new facade was also mounted in front of the existing structure. Thereby all projects where the facade was changed entirely or where an additional facade layer was mounted had a particularly high negative change in the reduction factor to account for the wall thickness.

In no. 1 (Office building in Bruck) also a new façade was mounted. Here, however, occurred only a change in the reduction factor of -2%. In contrast to the aforementioned projects in no. 1 parts of the existing façades were removed, so that the new window openings could be significantly larger than the window format in the building before renovation. However, in an enlarged window opening, a greater wall thickness has less effect on the well index of the wall.

In no. 9 (Kampen School, Oslo) no change in the well index occurred, since no additional insulation could be applied to the wall because the school building is a listed monument. In the other projects in which a thermal insulation was applied to the existing facade, the reduction in light transmission through the window system by the application of thermal insulation ranges from 1% to 3%.

As became clear in the previous sections, a change, both in the size of the floor area and in the size of the window have a significant influence on the effective window to floor area ratio. To be able to represent the change in the efficiency of the window system independently of these changes in size, Table 17 shows the effective window area per square meter of window area.

Table 17: Change in the specific effective window area per one square meter of window area through the renovation.

	Building	Floor	Room-type	Room id	$A_{\text{eff-Win}}/\text{m}^2$		
					before	after	change
1.	AT_Bruck_Admin-building	3	office	2.20	0,40	0,42	+4%
2.	AT_Graz_Franziskanerkloster	3	living room	10	0,33	0,29	-12%
3.	AT_Schwanenstadt_Schule	2	classroom	4	0,48	0,36	-25%
4.	BE_Brussels_Forest_OCMW	2	office	2	0,45	0,32	-30%
5.	DE_Olbersdorf_OS0	3	classroom	310	0,33	0,27	-18%
6.	DE_Ulm_Kindergarten	1	group room	1	0,46	0,38	-16%
7.	DK_Copenhagen_Kindergarten	1	group room	19	0,44	0,36	-19%
8.	IT_Cesena_school	2	classroom	-	0,49	0,37	-24%
9.	NO_Oslo_Kampen-skole	2	classroom	-	0,42	0,36	-16%
10.	NO_Oslo_Powerhouse	3	office	-	0,40	0,34	-15%

The effective window area per m^2 window area shown in Table 17 allows an assessment only of the transparency of the window system without correlating the window area to the floor area of the space. Hence changes in the window area or in the floor area do not affect this metric. Prior to renovation this effective transparency of the window ranged from 0.33 to 0.49, the average was 0.42. After renovation, the effective transparency of the window ranged from 0.27 to 0.42, the average was 0.35. The mean reduction of the effective transparency of the window system by renovating the façade was 18%. It is striking that no. 1 (Office building in Bruck) with an increase in the effective transparency of the window system of 4% is an exception. A view at Table 16, in which the influencing reduction factors are listed separately, shows that a reduced frame portion is responsible for this exceptional behavior of case study no. 1. In the section "Window frame" this issue has already been discussed.

Apart from this particular case the change of the light transmission of the glazing is most influential regarding the reduction of the effective transparency of the window system in renovation. In comparison, the enlarged wall thickness contributes less to reducing the transparency of the window system.

7.2.1.6 Daylight factor

In order not only to assess the transparency of the window, but the lightness in the space as a whole, the daylight factor was calculated for the center of the space. It has to be noted, that the daylight factor was determined using simplified assumptions. Obstructions were only considered generically as a reduction factor, but the obstructing buildings have not been modeled. For boundary conditions, which were not known, standard assumptions were made. For example in most cases there was no information available regarding the reflectances of the room surfaces and the frame portion of the window. Also for the correction for dirt standard values were applied. Table 18 shows the calculated daylight factor.

Table 18: Daylight factor in the middle of the room before and after renovation.

					D	D	D
	Building	Floor	Room-type	Room id	before	after	change
1.	AT_Bruck_Admin-building	3	office	2.20	2,0%	0,8%	-60%
2.	AT_Graz_Franziskanerkloster	3	living room	10	0,3%	0,2%	-24%
3.	AT_Schwanenstadt_Schule	2	classroom	4	2,0%	1,0%	-48%
4.	BE_Brussels_Forest_OCMW	2	office	2	2,1%	1,4%	-33%
5.	DE_Olbersdorf_OS0	3	classroom	310	0,9%	0,7%	-25%
6.	DE_Ulm_Kindergarten	1	group room	1	1,7%	1,4%	-15%
7.	DK_Copenhagen_Kindergarten	1	group room	19	1,1%	0,7%	-29%
8.	IT_Cesena_school	2	classroom	-	1,6%	1,1%	-27%
9.	NO_Oslo_Kampen-skole	2	classroom	-	1,7%	1,4%	-16%
10.	NO_Oslo_Powerhouse	3	office	-	1,0%	1,3%	+33%

On average, the daylight factor was reduced by renovation from 1.4% to 1.0%, a reduction of 28%. In no. 10 (Powerhouse, Oslo), the daylight factor increased against the trend. The reason for this is that the office space at the façade was reduced in depth as part of the renovation activities. As a result the reference point in the center of the space moves closer to the window. This movement of the reference point as well as the widening of the window area raised the daylight factor in no. 10 by 33%. Due to the reduction in the depth of space no. 10 (Powerhouse, Oslo) is exceptional, for this reason this building sample was left out at the following considerations.

In no. 1 (Office building in Bruck), no. 3 (School in Swan City) and no. 4 (Forestry Commission in Brussels) the façade has been exchanged or an additional façade was mounted. In these examples, the reduction of the daylight accounted for -60%, -48% or -33% and was particularly high. Before renovation, these three buildings had a daylight factor of about 2% which is relatively high compared to the other buildings. On average, the daylight level was reduced by 50% in this group of buildings. After renovation, only no. 4 (Forest Service in Brussels) maintained a relatively high daylight factor in the center of the space relative to the other case study buildings. No. 4 (Forestry Commission in Brussels) is different from the two other members in this group since it has a perforated façade. The new facade was inserted on the inside between the existing façade and the interior space. This solution is quite special owed by the historic preservation. In no. 1 (Office building in Bruck) and no. 3. (School in Schwanenstadt) the façade was completely replaced, i.e., the old facade was removed and a new facade was mounted. The strong reduction of the daylight factor in no. 1 (Office building in Bruck) can be attributed to the fact that in addition to the reduction of the window area, the position of the window was lowered due to the new window lintel which had to be introduced since the supporting pillars of the existing façade had been removed. The lower window position after renovation is less favorable to daylighting in comparison to the position of the window before renovation.

In the projects, no. 2 (Franciscan monastery, Graz), no. 5 (Olbersdorfer school), no. 6 (kindergarten, Ulm), no. 7 (kindergarten, Copenhagen) and no. 8 (school Cesena), the existing facade was renovated by applying thermal insulation to the wall and replacing windows. Except for no. 6 (kindergarten, Ulm) which has a continuous band of windows, these buildings have a perforated facade. The renovation affected in this group of buildings on average, a reduction of the daylight levels by about a quarter. The smallest is the decline of 15% occurred in no. 6 (kindergarten, Ulm). It should be noted, that when renovating the listed kindergarten in Ulm, particular care was taken to maintain the existing window and glass proportions. Therefore the daylight level mainly was reduced by the lower light transmission of the new glazing. With a window to floor area ratio of 0.52 the proportion of window area in the group room of the kindergarten in Ulm is particularly high. Given the high level of daylight before the renovation, here a reduction of the daylight level was acceptable. For the other examples with perforated facades the level of daylight was already partially critically low, so that a reduction from the perspective of natural lighting is not acceptable. Nevertheless, a reduction in the daylight level also occurred in the renovation of these examples.

A special case is no. 9 (Kampen School, Oslo), since just a new window was installed without renovating the facade. In this project, the preservation of the listed building was a major concern with respect to the renovation strategy. Because of the reduced light transmission of the new glazing, the lighting level is reduced in this school by 5%.

7.2.2 Results based on renovation Types

When discussing the effect of renovation on the effective window to floor area ratio and to the daylight factor in the center of the space, it became clear that it is possible to identify groups with similar properties within the considered building examples. Figure 15 shows an estimate of the impact of renovation strategies for the building envelope on daylighting in buildings based on the daylight factor in middle of the space. When assessing the examples discussed here it should be remembered that the renovation primarily aimed on improving the thermal properties of the building envelope.

7.2.2.1 Installation of a new facade

One group of renovations consists of buildings, where a new facade was mounted. In no. 1 (Office building in Bruck), no. 3 (School in Schwanenstadt) and no. 10 (Powerhouse, Oslo) a new facade consisting of large prefabricated elements was mounted to the existing building shell. The assumption that a new facade provides the opportunity of reconfiguring size and equipment of the daylight openings and thereby avoiding a reduction in the daylighting level that otherwise is associated with the renovation of the facade, only applies to some extent. The office building in Bruck may serve as an example. The unfavorable lower position of the window results from the installation of a new window lintel that is necessary to bear the load of the floors since the supporting pillars of the old facade had been removed. At the school in Schwanenstadt massive beams adjacent to the facades have not been removed, so the new windows could not be located higher than the windows before renovation. The study shows, that the window in Bruck was more effective per square meter of window area after renovation than before renovation. This could be achieved by using large glass elements and reducing the portion of glazing bars. However, the window to floor area ratio in the selected space virtually halved, thus resulting in a significant reduction in the daylight level. In this case, reducing the window area was not a necessary consequence of the renovation, but a result of planning.

In Schwanenstadt the window size was maintained with the renovation. Nevertheless the daylight level was reduced by 48%. Reasons for this are the significantly lower light transmittance of the new triple-e glazing, the relatively low reflectance of the ceiling, the significantly thicker new facade and other factors.

The increase in window area in no. 10 (Powerhouse, Oslo) was substantially achieved by a lower parapet. The lintel was not moved upwards, though there is a potential of moving it about 30 cm upwards towards the ceiling. The increase in the daylight factor in the center of the space was mostly achieved by reducing the depth of the space.

The assumption that the installation of a new facade in front of the given structure enables an optimal solution with respect to the arrangement of the openings was disproved by the examples of no. 1 (office building in Bruck) and no. 3 (School in Schwanenstadt) since indispensable new structural components or not removable existing structural components did limit the possibility of creating an optimum solution with respect to daylighting. In no. 10 (Powerhouse, Oslo) daylighting has been improved with the renovation.

The fourth case, in which a new façade was mounted, is no. 4 (Forestry Commission in Brussels). This building is different from the case studies previously discussed since the old façade was not removed during renovation. The new facade was not mounted from the outside but from the inside of the existing facade. This approach made it possible to preserve the historic façade as a monument in the city, and nevertheless to renovate the building to a high energy standard. With the installation of the new facade, the daylight factor in the center of the space was reduced by one third.

7.2.2.2 Thermal insulation of walls + replacing windows

The group of case studies in which the exterior wall has been insulated and windows have been replaced, include no. 2 (Franciscan monastery, Graz), no. 5 (Olbersdorfer school), no. 6 (kindergarten, Ulm), no. 7 (Kindergarten, Copenhagen) and no. 8 (school in Cesena). Since for this type of renovation it is usually not possible to increase the window area the reduction of the daylight level induced by the renovation can only be limited. Typically individual solutions are implemented. In no. 2 (Franciscan monastery, Graz), for example, an oblique reveal allowed a larger interior window and thus a smaller reduction. However, this measure has not been performed in the observed space but in a different part of the building. In no. 5 (Olbersdorfer school) the outer pane of the box type window was glazed with white clear glass and parts of the Window surround were cut off to allow large box-type-windows. In addition, the inside wing has no glazing bars. Despite the efforts made in the individual projects the case studies of this type of renovation show consistently a reduction of the daylight factor in the center of the space and also the effective window to floor area ratio was reduced by renovation.

In no. 7 (kindergarten, Copenhagen) or no. 8 (school in Cesena) the renovation was used to install a glazing with an additional glass layer. In both of the above cases, the light transmission of the glazing reduced by 18%. The lower light transmission of the glazing after renovation is the biggest influencing factor in this group of examples. It should be noted that the influence of the frame portion could hardly be evaluated due to lack of data.

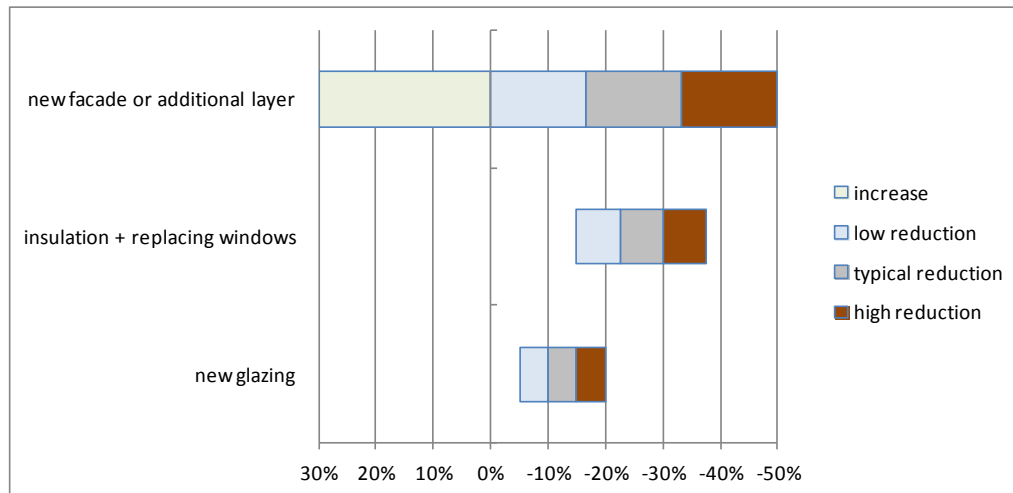

Figure 15: Estimate of the impact of strategies of thermal renovation of the building envelope on the daylighting level in buildings.

Figure 15 shows an estimate of the impact of thermal renovation strategies of the building envelope on the daylighting in buildings. For the renovation scenario of mounting a new facade the opportunity to raise the daylight level was considered. However, the previous study showed that in the individual case studies constraints have prevented from using this opportunity.

Given the disillusioning result that the renovation of the building envelope, almost without exception is decreasing the daylight level in the selected spaces, it can only be concluded, that daylighting issues should be given greater consideration in the planning of renovation activities.

7.2.3 Electric lighting

The renovation of the case study projects in Task 47 is generally a few years old. Since the date of renovation is important with respect to the technological development of solid state lighting Table 19 lists the date of renovation for all relevant case studies.

Presumably the decisions regarding the electric lighting strategy have been made one or two years in beforehand of renovation. Since 2010 LED technology started to be competitive. In the first years only for a few applications LED-lighting was more efficient compared to fluorescent sources. Generally the first LED installations were costly.

The renovation of the Kindergarten in Ulm, which was completed in 2012 is among the newest case study buildings. In the Ulm Kindergarten compact fluorescent lamps were used. So far in none of the case study buildings being subject of the cross analysis in lighting LED's were used. Today, in 2015 solid state lighting technology is clearly more energy efficient than fluorescent lighting technology. With respect to electric lighting the case studies of Task 47 hence do no more reflect the current state of the art.

Table 19: Lighting power density in the selected space before and after renovation.

	Building	Floor	Room-type	Room id	p		change
					before	after	
1.	AT_Bruck_Admin-building	3	office	2.20	28,0 W/m ²	24,6 W/m ²	-12%
2.	AT_Graz_Franziskanerkloster	3	living room	10	5,7 W/m ²	5,7 W/m ²	0%
3.	AT_Schwanenstadt_Schule	2	classroom	4	18,7 W/m ²	11,6 W/m ²	-38%
4.	BE_Brussels_Forest_OCMW	2	office	2	12,6 W/m ²	7,0 W/m ²	-45%
5.	DE_Olbersdorf_OS0	3	classroom	310	17,0 W/m ²	8,2 W/m ²	-52%
6.	DE_Ulm_Kindergarten	1	group room	1	-	8,7 W/m ²	-
7.	DK_Copenhagen_Kindergarten	1	group room	19	8,2 W/m ²	8,2 W/m ²	0%
8.	IT_Cesena_school	2	classroom	-	6,3 W/m ²	6,3 W/m ²	0%
9.	NO_Oslo_Kampen-skole	2	classroom	-	23,4 W/m ²	12,8 W/m ²	-45%
10.	NO_Oslo_Powerhouse	3	office	-	-	-	-

Table 20 shows the specific installed lighting power density before and after renovation. If the power density in a case study did not change, electric lighting was not part of renovation activities. If the power density is not specified, the value could not be determined.

Due to different lighting requirements in the different case study buildings it is not very meaningful to compare the absolute value of the specific installed power density. It also has not been studied here, to which extent the lighting requirements were met in the different projects. For example the relatively low value of 5.7 W / m² in No. 2 (Franciscan monastery, Graz) is not an outcome of efficient lighting technology, but is due to low lighting levels. This shows, that in addition to energy efficiency the lighting quality always needs to be considered when discussing renovation strategies for electric lighting. Without an evaluation of the lighting quality a statement about the success of an electric lighting retrofit is not complete. However, there was not sufficient information available in order to evaluate lighting quality in the case study buildings. Therefore the discussion in this cross analysis is limited to energy efficiency figures.

Table 20: Lighting power density in the selected space before and after renovation.

	Building	Floor	Room-type	Room id	p		change
					before	after	
1.	AT_Bruck_Admin-building	3	office	2.20	28,0 W/m ²	24,6 W/m ²	-12%
2.	AT_Graz_Franziskanerkloster	3	living room	10	5,7 W/m ²	5,7 W/m ²	0%
3.	AT_Schwanenstadt_Schule	2	classroom	4	18,7 W/m ²	11,6 W/m ²	-38%
4.	BE_Brussels_Forest_OCMW	2	office	2	12,6 W/m ²	7,0 W/m ²	-45%
5.	DE_Olbersdorf_OS0	3	classroom	310	17,0 W/m ²	8,2 W/m ²	-52%
6.	DE_Ulm_Kindergarten	1	group room	1	-	8,7 W/m ²	-
7.	DK_Copenhagen_Kindergarten	1	group room	19	8,2 W/m ²	8,2 W/m ²	0%
8.	IT_Cesena_school	2	classroom	-	6,3 W/m ²	6,3 W/m ²	0%
9.	NO_Oslo_Kampen-skole	2	classroom	-	23,4 W/m ²	12,8 W/m ²	-45%
10.	NO_Oslo_Powerhouse	3	office	-	-	-	-

In average of all the case studies, for which data were available, the reduction of the specific installed lighting density through the renovation was 24%. If only those case studies where the lighting system had been renovated are considered, the average reduction was 38%. If new fittings were installed, occupancy responsive controls and daylight responsive controls were installed as well. Therefore the actual increase in energy efficiency is higher than suggested by the reduction of specific installed power density. In no. 5 (Olbersdorfer school), for example, the electric lighting energy was determined by measurement. The specific consumption before renovation of 11.0 kWh / m² was reduced to 2.7 kWh / m² after renovation, the savings thus amounted to 75%. The reduction of the specific installed power density was, however, as Table 20 shows "only" 52%. Overall, the case studies show, that significant savings can be realized through the renovation of the electric lighting system.

8 Holistic comparison

Benjamin Köhler, Fraunhofer ISE
Doreen Kalz, Fraunhofer ISE

The achievement of objectives related to heating, cooling and primary energy demand as well as interior comfort in summer before the retrofit, the design and the monitoring are illustrated in diamond diagrams. In the diagrams each parameter is plotted on an own axis with the highest/ lowest value in the centre and the best value at the end of the axis. A detailed explanation of the approach can be found in chapter 3.5. The design values are plotted in a green diamond, the values before the retrofit and the monitored values are plotted in light blue.

AT01: School Schwanenstadt

The main objectives of the project AT01 was to significantly reduce the heating and primary energy demand compared to the situation before the retrofit from about 120 to less than 20 $\text{kWh}_{\text{th}}/(\text{m}^2\cdot\text{a})$ and almost 400 to below 100 $\text{kWh}_{\text{prim}}/(\text{m}^2\cdot\text{a})$ respectively. In the same time thermal indoor comfort with respect to comfort category II of EN 15251 should be improved from 75% to at least 95% during occupancy. Cooling energy demand did not play a role in the project (compare plot on the left side of Figure 16). In the right plot of Figure 16 the design and monitoring data (after retrofit) are plotted. It can be seen that objective of a high indoor comfort was achieved and the reduction in primary energy demand exceeded the goal. Concerning the reduction in heating energy demand, the aim of a reduction of approx. 83% to 20 $\text{kWh}_{\text{th}}/(\text{m}^2\cdot\text{a})$ was not achieved and the heating energy demand was only reduced by 33% to 40 $\text{kWh}_{\text{th}}/(\text{m}^2\cdot\text{a})$. As mentioned before cooling energy demand did not play a role in the refurbishment project.

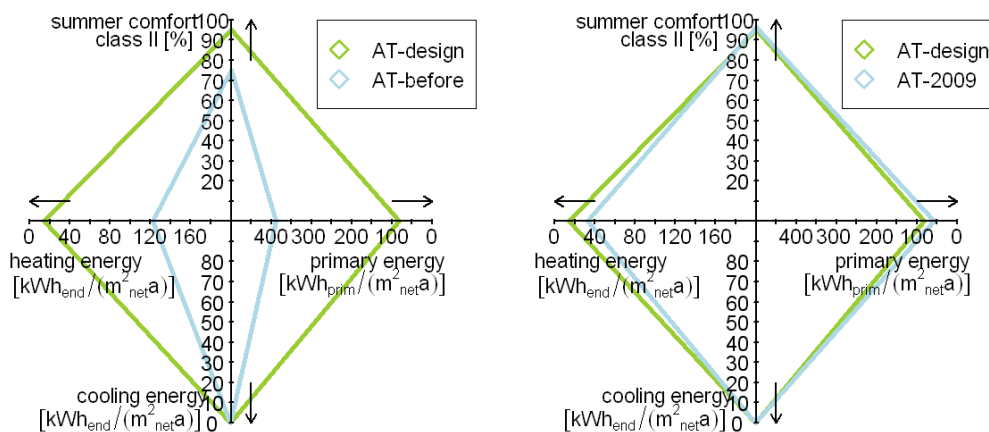

Figure 16: Diamond diagram illustration the indoor comfort during summer as well as the heating, cooling and primary energy demand before and after the retrofit of the demonstration building AT01. Additionally, the design-values are plotted.

DK: Kindergarten Vejtoften, Hoje Taastrup

The aim of the project DK was to reduce the heating energy demand by approx. 50% from 100 to less than 50 $\text{kWh}_{\text{th}}/(\text{m}^2\cdot\text{a})$ and the primary energy demand from 150 to 100 $\text{kWh}_{\text{prim}}/(\text{m}^2\cdot\text{a})$. In the same time thermal comfort during occupancy with respect to comfort category II improved from 75 to at least 95%. Cooling energy demand did not

play a role in the project. The values of the design and the situation before refurbishment are plotted on the left side of Figure 17. In the right plot of Figure 17 the design and monitoring data (after retrofit) are plotted. It can be seen that reduction objective concerning heating energy demand has been achieved, while the goal of reducing primary energy demand to $100 \text{ kWh}_{\text{prim}}/(\text{m}^2\cdot\text{a})$ was missed slightly (achieved primary energy demand of $125 \text{ kWh}_{\text{prim}}/(\text{m}^2\cdot\text{a})$). Whether the aim of improving the indoor comfort during summer was achieved or not can't be said as the needed monitoring data is not available.

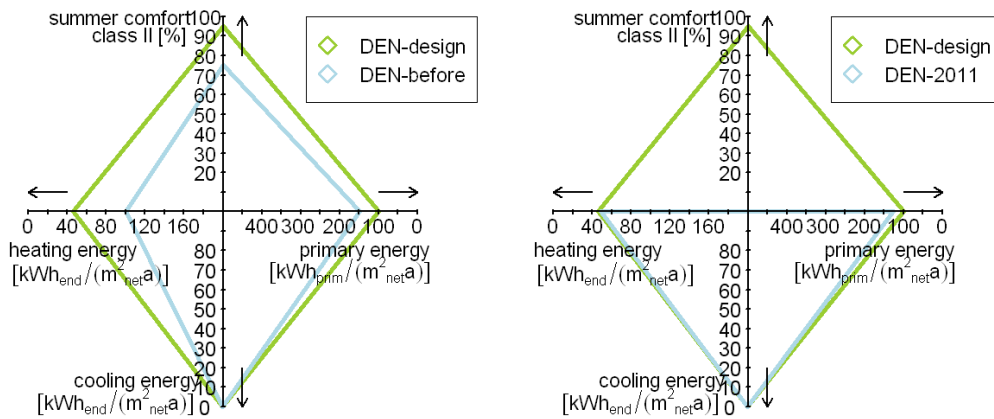

Figure 17: Diamond diagram illustration the indoor comfort during summer as well as the heating, cooling and primary energy demand before and after the retrofit of the demonstration building DK. Additionally, the design-values are plotted.

GER01: School/ Kindergarten, Ulm

The main goal of the project GER01 was to reduce the heating energy demand significantly from almost 200 to approx. $70 \text{ kWh}_{\text{th}}/(\text{m}^2\cdot\text{a})$. Meanwhile, the primary energy demand ought to be reduced by 50% from 200 to $100 \text{ kWh}_{\text{prim}}/(\text{m}^2\cdot\text{a})$. Thermal comfort during occupancy with respect to comfort category II should be improved from 75 to at least 95%. As in the previous demonstration projects cooling energy demand did not play a role. The values of the design and the situation before refurbishment are plotted on the left side of Figure 18. In the right plot of Figure 18 the design and monitoring data (after retrofit) are plotted. The reduction objective concerning heating energy demand has not been achieved (only reduction to approx. $90 \text{ kWh}_{\text{th}}/(\text{m}^2\cdot\text{a})$), while the goal of reducing primary energy demand to $100 \text{ kWh}_{\text{prim}}/(\text{m}^2\cdot\text{a})$ was almost accomplished. The goal of achieving comfort category II during at least 95% of the occupancy hours was met and even exceeded (thermal comfort according to category II during almost 100%). As mentioned before cooling energy demand did not play a role in the refurbishment project.

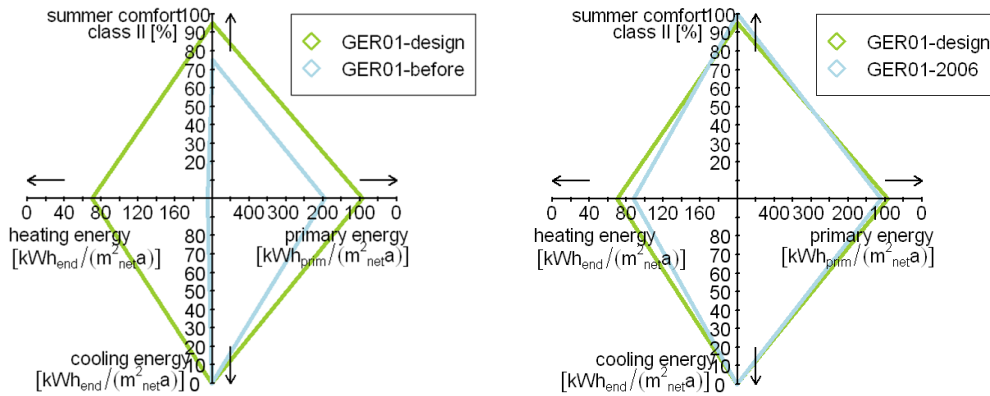

Figure 18: Diamond diagram illustration the indoor comfort during summer as well as the heating, cooling and primary energy demand before and after the retrofit of the demonstration building GER01. Additionally, the design-values are plotted.

GER03: Printing workshop and Office Building, Karlsruhe

The goals of the project GER03 with respect to all four parameters plotted were very ambiguous (see left side of Figure 19). Heating energy demand should drop from 160 to approx. 30 kWh_{th}/(m²·a), primary energy demand from approx. 330 to 50 kWh_{prim}/(m²·a). Thermal comfort during occupancy with respect to comfort category II should be improved from 65 to at least 95%. In the right plot of Figure 19 the design and monitoring data (after retrofit) are plotted. The plotted monitoring results are from the year 2012 after finalizing the project and optimizing the operation of the technical building services installed. With a heating demand of less than 20 kWh_{th}/(m²·a) the reduction objective has been more than fulfilled, while the goal of reducing primary energy demand to 50 kWh_{prim}/(m²·a) was missed (achieved primary energy demand of slightly below 150 kWh_{prim}/(m²·a)). The goal of achieving comfort category II during at least 95% of the occupancy hours was met and even exceeded (thermal comfort according to category II during almost 100%). The reduction target in cooling energy demand was almost met (approx. 5 kWh_{el}/(m²·a) in 2012).

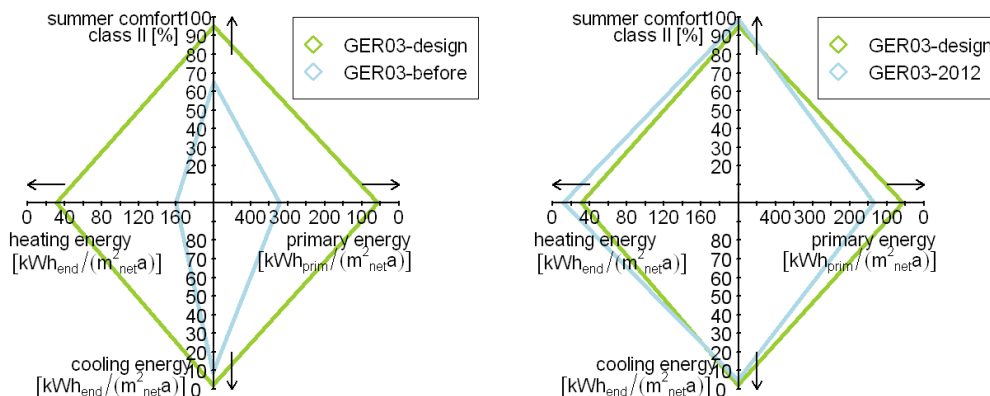

Figure 19: Diamond diagram illustration the indoor comfort during summer as well as the heating, cooling and primary energy demand before and after the retrofit of the demonstration building GER03. Additionally, the design-values are plotted.

9 Special technologies and topics studied

9.1 Box Type Windows

Daniel Brandl, TU Graz
 Thomas Mach, TU Graz
 Werner Lerch, TU Graz

9.1.1 Motivation

Wooden Box Type Windows (BTW) are an integral part of the historical grown cities in Europe. While this type of window was a crucial element for the design of the building's facades over centuries in the past, the quantity of BTW is decreasing due to the actual modernization activities. The European Cities in the temperate climate zones still contain a large number of buildings which were built in the 19th to the mid of 20th century. Furthermore several of them are classified as historical monuments. For example in Germany and Austria more than 100 million BTWs can be assumed on the historical buildings' facades [20], [21], [23].

The on the left side positioned schematic in Figure 20 shows the composition of a typical BTW and the main components. Principally a BTW consists of two casements with single glazing (interior (1), exterior (2)), a wooden base (3) and a wooden shutter box (4) where the shading system is integrated. The distance between the exterior and the interior casement usually is about 150 and 200 [mm] [3], [20].

Between the casements and the wooden box frame structure occur small, air permeable joints (5), where external air can infiltrate or leave the BTW's cavity, and so provides a natural air change for the interior room. The joint's width is about 1 to 2 [mm] for the interior casement and approximately 3 to 4 [mm] for the exterior casement [3], [20].

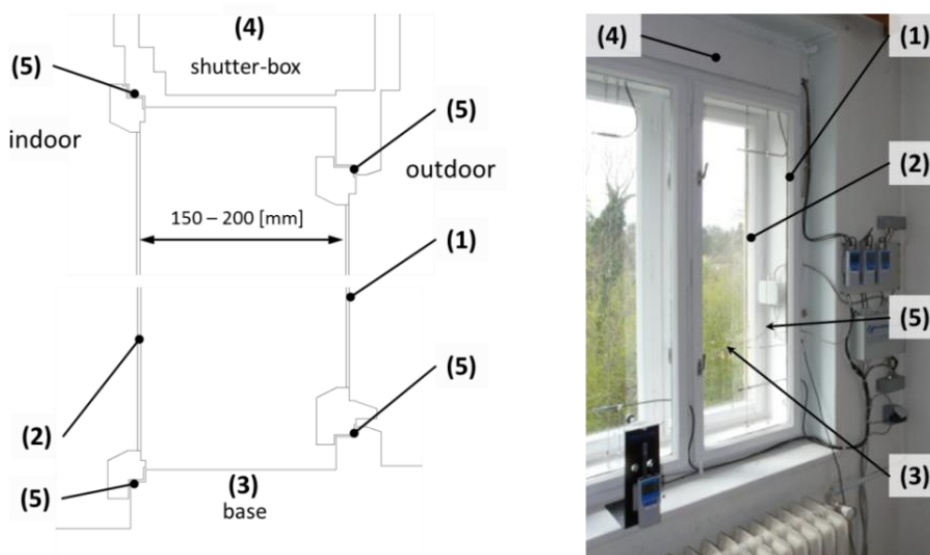

Figure 20: Schematic of a BTW where the main components are indicated (left, schematic is from the SB13 Conference presentation [20]), picture of a BTW equipped with a quantity of measurement sensors (right, picture is from the "denkmalaktiv I" research project [24]).

The following description of some typical properties of historic BTWs shows that the conservation of this window could be associated with several important benefits.

- **Cultural aspects** - BTWs make a significant contribution to the overall appearance of many historical buildings in Europe. The replacement of these BTWs with contemporary windows mostly has disturbing influences on the architectonic balance of the façades.
- **Thermal protection** - The renovation and improvement of BTWs can reduce the buildings' energy consumption. If such improved BTWs may keep up with contemporary windows in their thermal performance not yet been finally clarified.
- **Sound protection** - BTWs generally have a good sound protection characteristic because of their large distance between the exterior and interior casement. The air permeable joints as well as improper glass thickness for the panes can have a negative impact on the all overall sound protection.
- **Lighting** - Due to the effort to reduce the heat losses additional panes are included in the the design layout of contemporary windows. The additional panes and the related frames with larger dimensions lead to a reduction of the amount of natural light passing and as a consequence to a negative impact on the lighting.
- **Life Cycle aspects** – The renovation of BTWs provides a lower degree of intervention in the building structure as the replacement by a contemporary window. Furthermore, it should be noted that the lifetime of a today manufactured window is assumed to be between 15 and 30 years. For existing BTWs installed for over 100 years another 100 years of functional ability are quite possible.

9.1.2 Study approach

Because of the insufficient knowledge about the thermal behaviour and the flow characteristic in the BTWs' cavities, an analysis was made to identify the physical processes. A numerical approach was chosen for the determination of airflow and the contours of temperatures inside the cavity as well as for the solid materials. This numerical approach enabled an easy way to investigate BTWs and some proper renovation concepts. A better understanding of the physics inside of a BTW can lead to new methods for renovation and has a positive impact on the decision to preserve a BTW in our cities' buildings in the future.

This study contains a short summary of two recent analyses ([3], [20]) and a national research project [24] of natural convection and heat transfer of historical BTWs. One of these studies also shows the impact of some promising thermal improvements on the thermal performance of BTWs [20]. Furthermore this study contains a comprehensive heat flux analysis and a virtual test box for U-value estimation. Two dimensional Computational Fluid Dynamics (CFD) simulations were used to reproduce the complex physical processes which occur inside the BTW cavity and the close environment. The simulation's results of two concepts were compared with in situ measurements to examine their quality [3], [20].

Weather conditions of the temperate climate very often lead to deformation of the wooden BTW parts, especially the casement frames are affected. Due to the deformation the air permeable joints' width can increase and so negatively influence the indoor climate. To avoid this uncomfortableness for the indoor climate six concepts of improvement have been chosen for investigation based on the (A) refurbished BTW.

A schematic of the (A) refurbished BTW and the improvements are shown in Figure 21. In the first concept the air permeable joints of the interior casement are closed with an (B) inner gasket frame, so that the air from the external cannot infiltrate the interior room. In the next concept the interior glass is exchanged by a (C) thermal insulation glass. A further improvement is the integration of thermal insulation the BTW's shutter box. This

concept also contains the inner gasket frame, used as improvement in concept (B). An additional interior casement is attached in concept (D), which forms a cavity between the BTW and interior room. Again the air from exterior cannot infiltrate the interior room. Another concept to improve the thermal performance of a BTW is a (E) airtight vertical divider for the BTW's cavity, to split it into two air chambers. The air can infiltrate the BTW's cavity from external environment as well as from the interior room. In concept (F) the refurbished BTW (A) has a low emission coating on the interior glass to reduce the effect of the radiant heat exchange between the glasses. Concept (G) also has a low emission coating on the interior glass in combination with the inner gasket frame from concept (B).

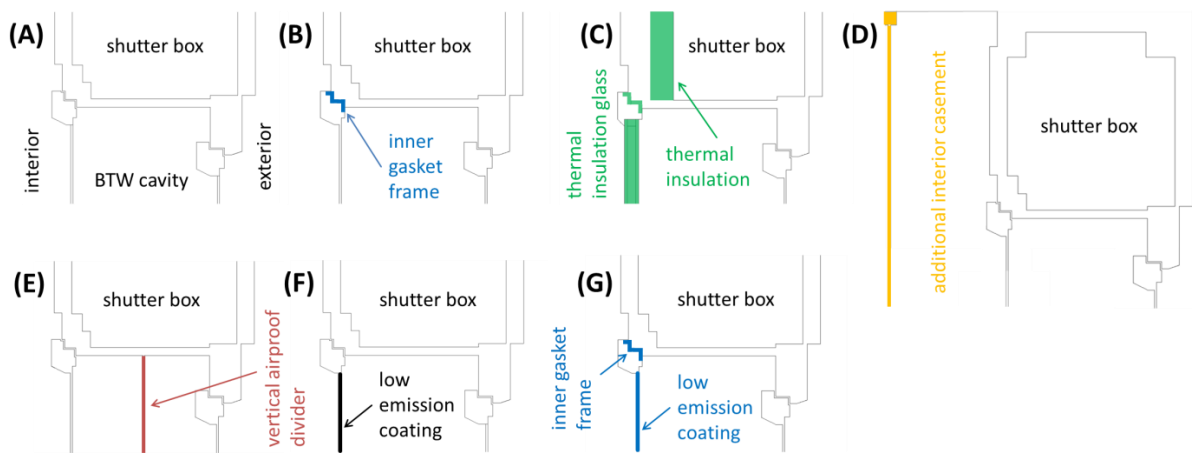

Figure 21: Schematic of the considered concepts of improvement for BTWs [20].

All seven case files (the base BTW (A) included) with the different renovation concepts were computed by using the CFD model geometry (Figure 23) as well as the two geometries for the U-value determination (Figure 37). The comparison of the thermal performance of the renovation concept using the origin geometry was presented in the past [20], as well as the U-value calculation of the concepts (A), (B), (F) and (G) [3]. The calculated U-values from the concepts (C), (D) and (E) are firstly present in this study (in chapter 9.1.7).

9.1.3 Numerical approach

For the determination of convective air flow, heat transfer and thermal characteristic of BTWs the CFD software ANSYS Fluent [26] was used. For the modelling required meshes and geometries were produced with the ANSYS related software Gambit [26]. More details about the simulation model development are given by recent studies [3], [20]. As a result we receive a two dimensional simulation geometry (a detail of the mesh is shown in Figure 22) containing the BTW construction with all for the investigation required parts and details (base, shutter box, air permeable joints etc.), the building's envelope as well as an interior room (equipped with heater) and a part of the external environment (Figure 23). The simulation geometry additional contains the interior room's adjacent walls, simplified in form of a solid block.

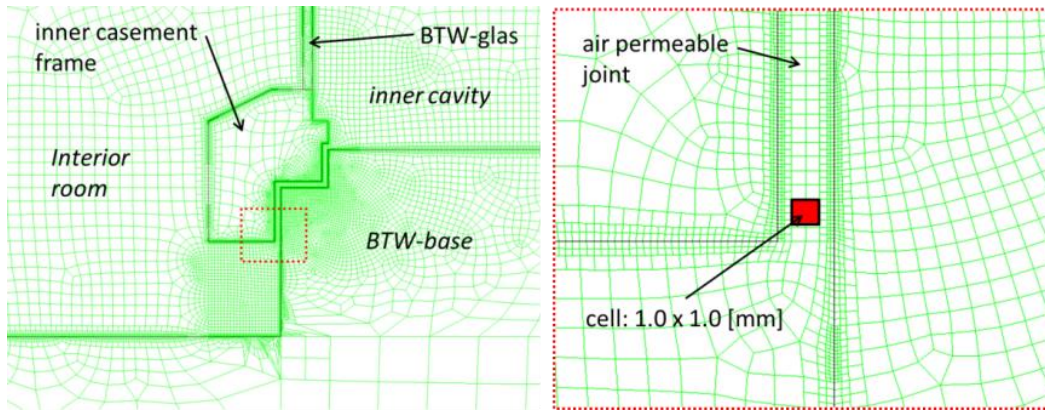

Figure 22: Detail of the two dimensional mesh for the CFD simulation [20].

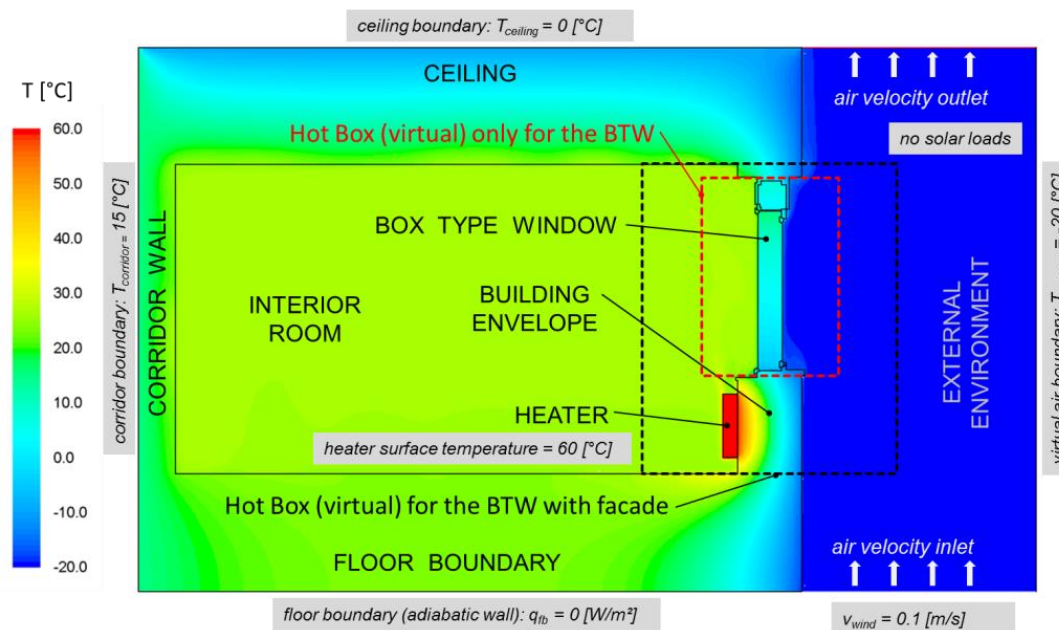

Figure 23: Two dimensional CFD model of the BTW, the interior room with adjacent walls and a part of the external environment [20].

Boundary conditions:

- The BTW was investigated for a cold winter night with an ambient temperature of -20°C and without solar radiation.
- According to wind speed measurements and a special numerical simulation [24] a wind speed of 0.1 m/s along the buildings envelope's height was assumed.
- The investigated interior room with the BTW is located in the second floor with the assumption that the room below is at the same temperature (no heat transfer through the floor boundary).
- To consider the heat losses through the ceiling a simplified solid block with a ceiling temperature of 0°C is implemented.
- The corridor wall has a boundary temperature of 15°C .
- The heater inside the interior room has a surface temperature of 60°C

All simulations were performed at steady state conditions, using the realizable $k-\varepsilon$ turbulence model with enhanced wall treatment and full buoyancy effects for the computation of airflow. Further the Discrete Ordinate radiation model was used for considering the exchange of long-wave radiation between in the simulations involved surfaces. More

details about the used numerical models can be found in the ANSYS Fluent User/Theory Guide [26]. Table 21 shows the required material properties, which were used in the two dimensional case files. An assumption of uniform material properties for the masonry walls (building envelope, ceiling, floor, corridor wall) was made. Furthermore constant material properties for all wooden parts of the BTW were assumed.

Table 21: In the CFD simulation used material properties.

	density kg/m^3	specific heat capacity $J/(kg \cdot K)$	thermal conductivity $W/(m \cdot K)$
window glass	2500	720	1.0
masonry walls	1620	882	0.38
wooden parts	600	2720	0.13
thermal insulation	500	1000	0.05

9.1.4 Measurement vs. Simulation

For proving the CFD simulations` quality, a comparison with monitored data from in situ measurement directly was made. During the research project "denkmalaktiv I" [24], several data (temperature, radiation and humidity) of an (A) refurbished and an (B) improved BTW were monitored [22]. The numbering of these BTWs corresponds to the description of the renovation concepts in Figure 21. A former mental home (now a public kindergarten) was one of the project`s reference objects, where the data from two installed BTWs were collected Figure 25.

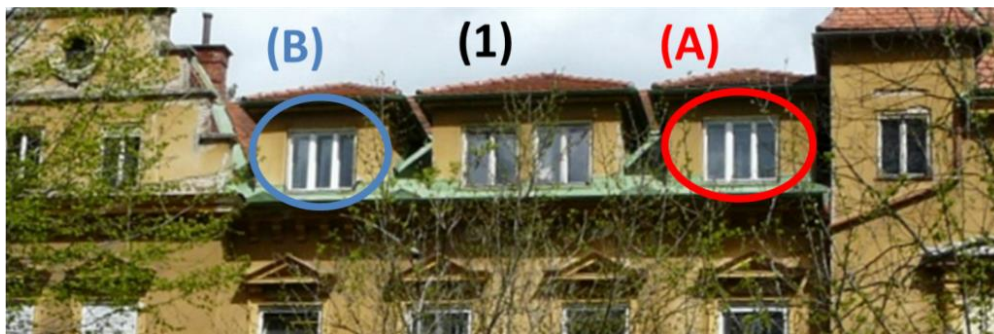

Figure 24: (1) reference object of the research project "denkmalaktiv I" [24] in Graz, Austria showing the investigated windows [22].

Figure 25 shows a schematic and a picture of one of these BTWs containing all for this study relevant temperature sensors. The two identical BTWs have rooms with similar geometry and were used for a comparison with the simulation results. The main dimensions of the windows are 1.63 x 1.76 x 0.28 m (Width x Height x Length). Each of the two BTW`s casements consists of three window parts, two of which can only be opened simultaneously. A shutter box is the upper enclosure of the inner cavity. The dimensions of the inner cavity are 1.36 x 1.49 x 0.21 m (Width x Height x Length), adjacent masonry is about 0.55 m thick. The joints between casement and frame are varying about 0.5 and 5.0 mm [20].

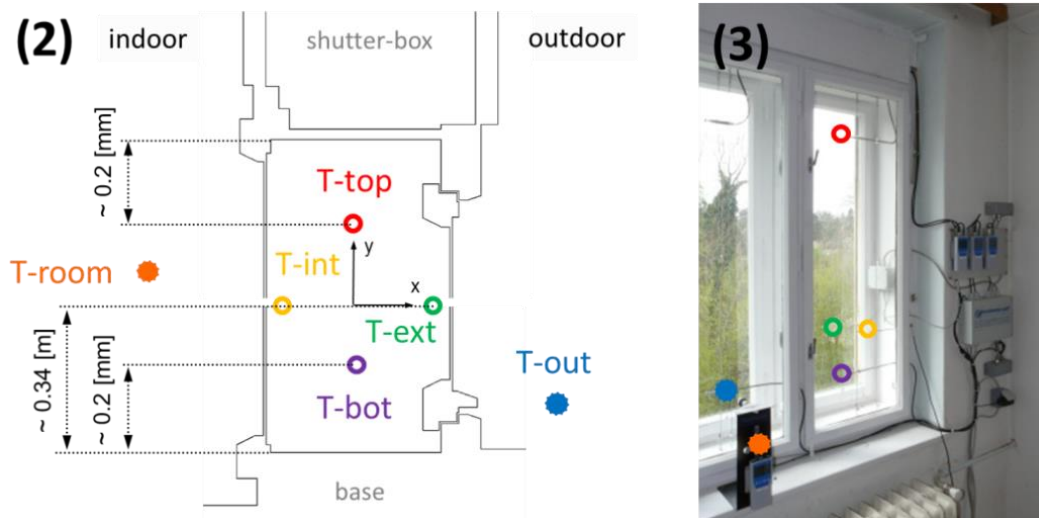

Figure 25: schematic (2) and a picture (3) of the improved BTW (B) with temperature sensors [22].

For example Figure 26 shows an extraction of the monitored temperatures from February 2012 of the (A) refurbished and the (B) improved BTW. The figure also shows the room temperature (T room) as well as the external temperature (T-out) close to the window. The external temperature was ranging between -15 and 10 °C while temperature was approximately between 20 and 30 °C in the refurbished BTW's room and between 30 and 40 °C in the improved BTW's room. Temperature peaks in the inner cavity were resulting from the influence of solar radiation [2].

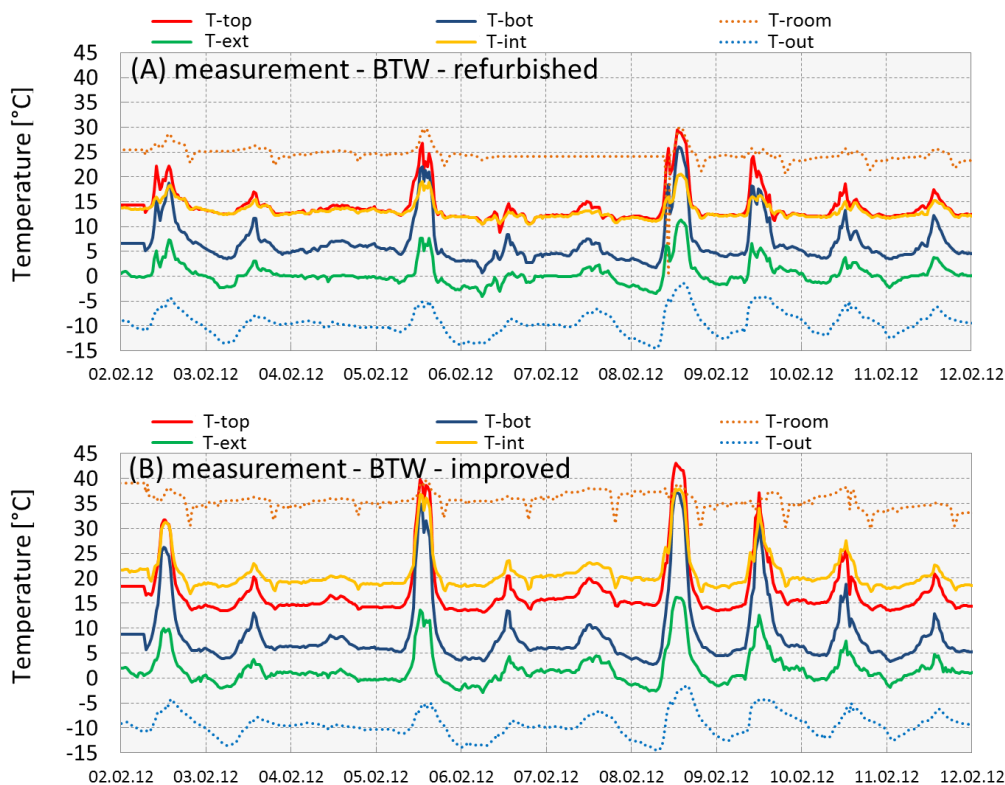

Figure 26: Extraction of the monitored temperatures in February 2012 for (A) refurbished and (B) improved BTW [22].

The constant monitored temperatures from 4th February (0:00 a.m.) to 5th February (5:00 a.m.) were perfectly suitable for a comparison of the steady state CFD simulations. For this purpose the monitored air temperatures inside the BTWs' cavities from 5th February at 4:00 a.m. were compared with the CFD simulations, where monitored interior room temperature (T-room) and external temperature (T-out) were used as boundary conditions. In Figure 27 the diagrams show the dimensionless temperature (T_h stands for the heater surface temperature) along the BTW's height.

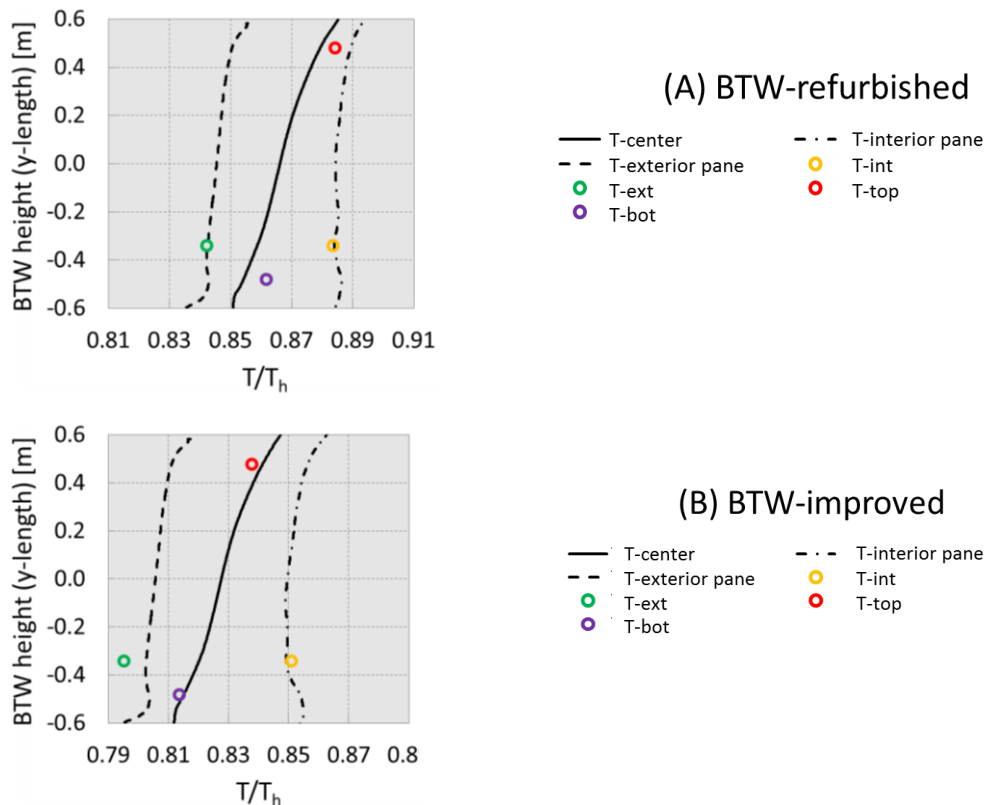

Figure 27: Comparison of monitored and computed air temperatures inside (A) refurbished and (B) improved BTW [3].

In a large part the monitored air temperature did match with the results from simulations. Only the top and bottom air temperature was little deviating from computed temperature profile for the (A) refurbished BTW, whereas the monitored temperature was slightly lower than the resulting value from the CFD simulation. Figure 29 contains three sections of temperature and buoyancy velocity profiles along the BTW height (at the middle position of BTW-length and in 10 mm distance to exterior and interior window glass).

9.1.5 Temperature and Velocity Profiles

In this chapter the main characteristics of air temperatures and velocities are presented. Figure 28 includes temperature and velocity profiles along the length of the BTW cavity at the middle of the BTW's height, 20 mm distanced below the upper cavity edge as well as 20 mm in distance above the bottom edge of the cavity. The temperature profiles showed a stratification of temperature along the height of window's cavity where temperature was increasing upwards. The profiles indicated fluctuations of temperature near the air permeable joints.

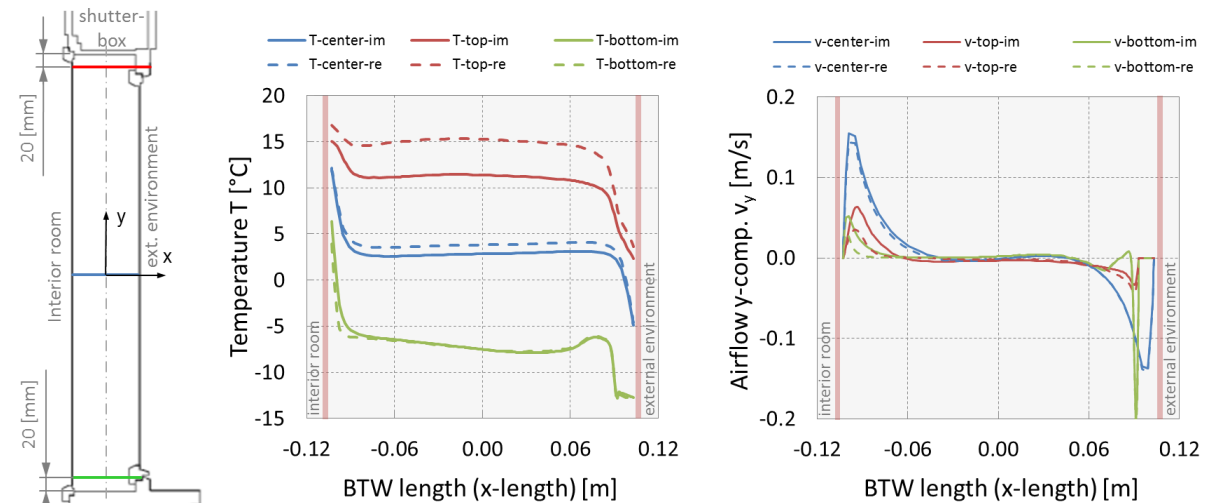

Figure 28: Temperature and Buoyancy velocity profiles along the BTW length of the (A) refurbished and the (B) improved BTW

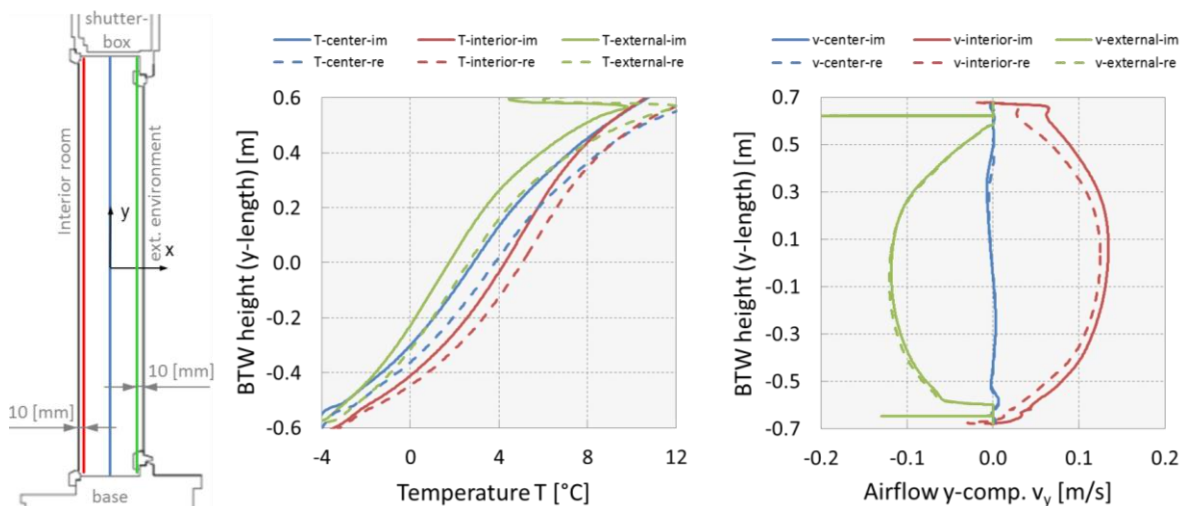

Figure 29: Temperature and Buoyancy velocity profiles along the BTW length of the (A) refurbished and the (B) improved BTW

The buoyancy velocities of convective flow along the window glasses reached a maximum in the middle of the BTWs' height. The thickness of these flows varied between 3 and 12 mm. In the middle of the BTW's length a zone was obtained, that showed almost no buoyancy velocity. More details about the temperature distribution and the airflow characteristic of the BTW and it's close environment can be found in the recent research studies [3], [20] and [24].

9.1.6 Heat Flux Analysis

In this chapter a detail heat flux analysis of all BTW concepts is presented. For this analysis a new simulation model was created for each improvement concept. Again the boundary conditions of a cold winter day were used for all simulations of the heat flux analysis (same boundary conditions as in chapter 9.1.3). In the following seven figures the relevant surfaces heat fluxes are indicated by red coloured arrows, the heat fluxes' magnitudes are inscribed beside the corresponding arrows in $[W/m^2]$.

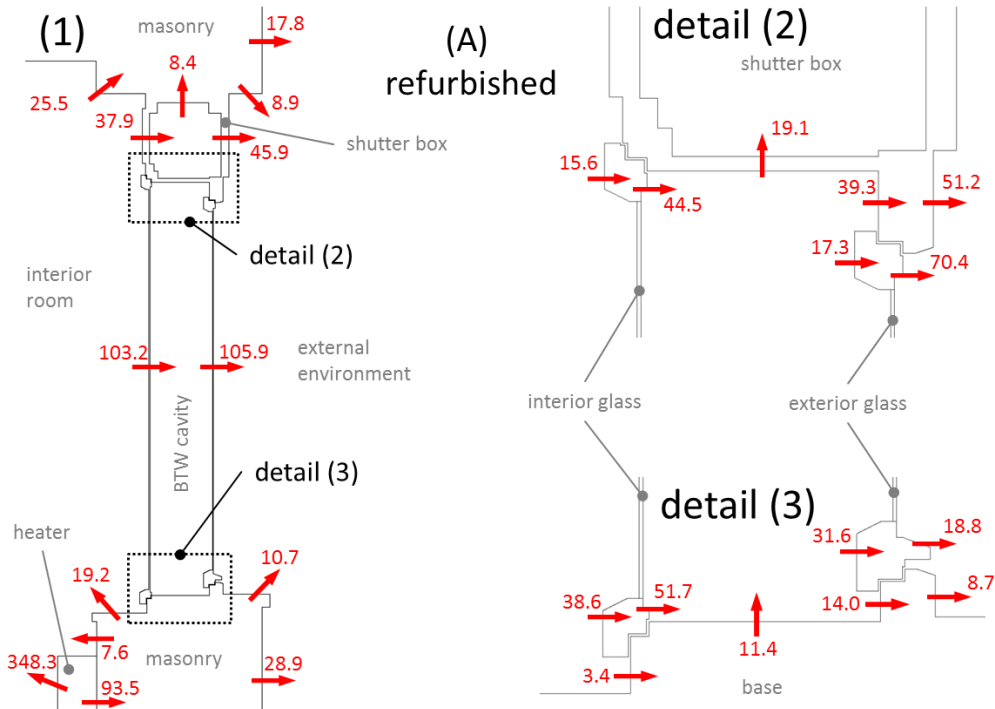

Figure 30: Section of the simulation geometry of the (A) refurbished BTW where the relevant surface heat fluxes are indicated (red coloured arrows). [W/m²] is used as unit for the heat flux's magnitude, inscribed beside the arrows.

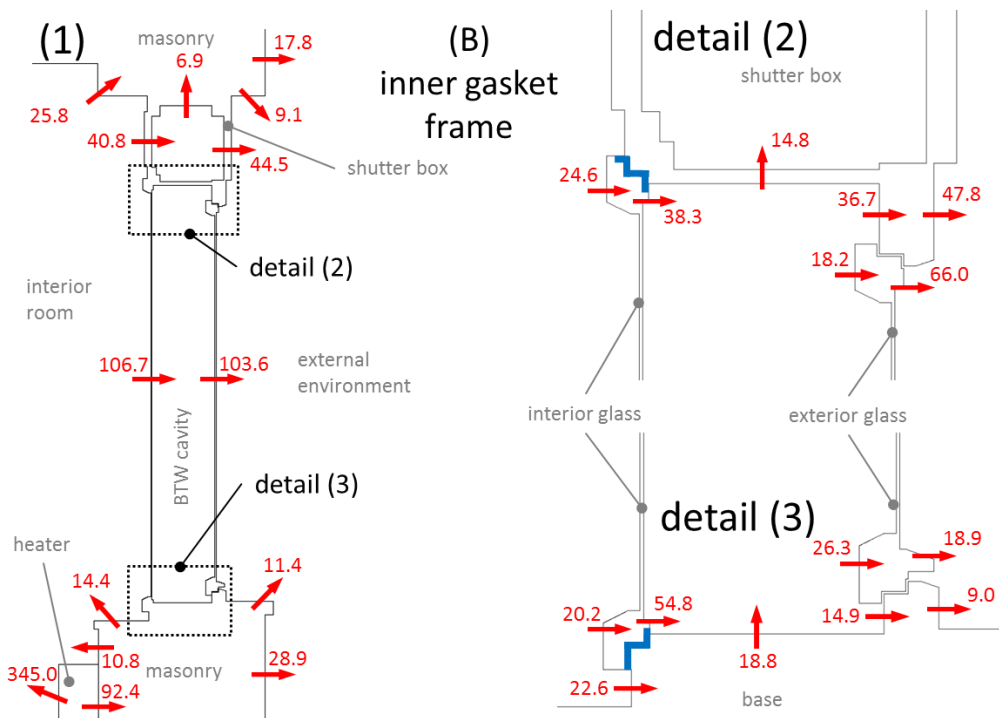

Figure 31: Section of the simulation geometry of the BTW with the (B) inner gasket frame. The relevant surface heat fluxes are indicated (red coloured arrows). [W/m²] is used as unit for the heat flux's magnitude, inscribed beside the arrows.

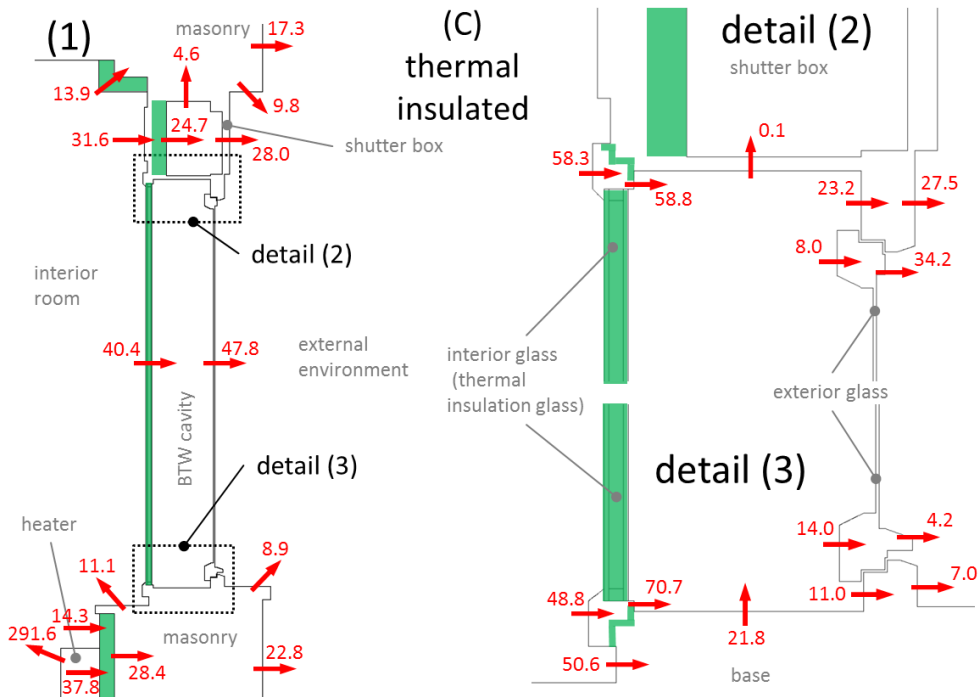

Figure 32: Section of the simulation geometry of the BTW with the (C) thermal insulation glass. The relevant surface heat fluxes are indicated (red coloured arrows). $[W/m^2]$ is used as unit for the heat flux's magnitude, inscribed beside the arrows.

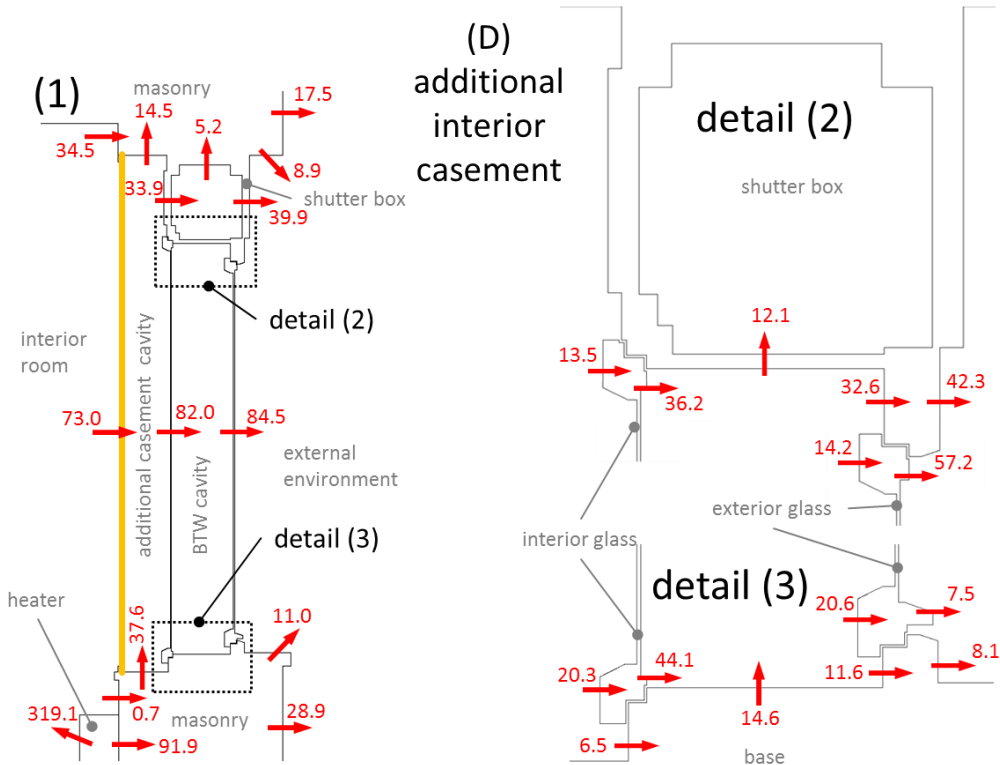

Figure 33: Section of the simulation geometry of the BTW with the (D) additional interior casement. The relevant surface heat fluxes are indicated (red coloured arrows). $[W/m^2]$ is used as unit for the heat flux's magnitude, inscribed beside the arrows.

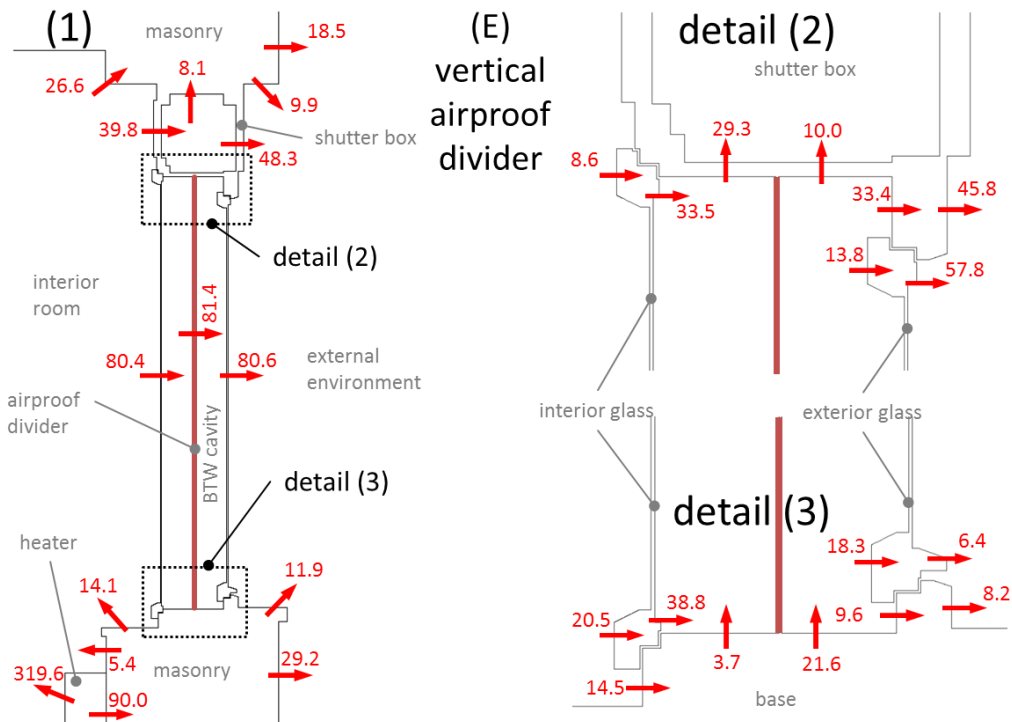

Figure 34: Section of the simulation geometry of the BTW with the (E) vertical airproof divider. The relevant surface heat fluxes are indicated (red coloured arrows). [W/m²] is used as unit for the heat flux's magnitude, inscribed beside the arrows.

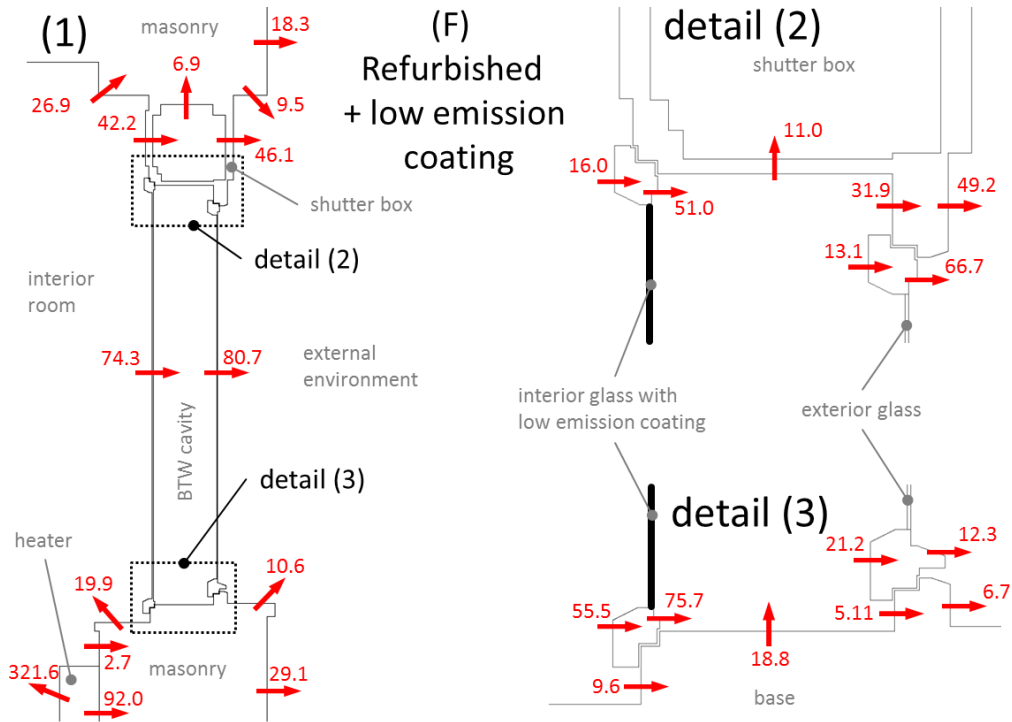

Figure 35: Section of the simulation geometry of the (F) refurbished BTW with a low emission coating on the interior glass. The relevant surface heat fluxes are indicated (red coloured arrows). [W/m²] is used as unit for the heat flux's magnitude, inscribed beside the arrows.

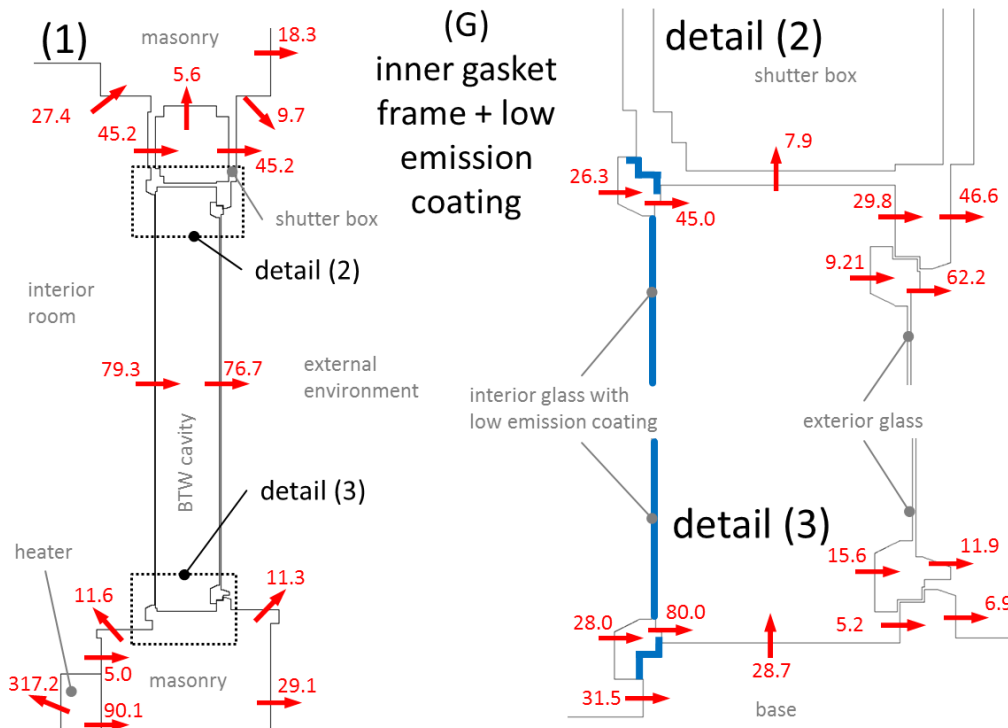

Figure 36: Section of the simulation geometry of the (G) BTW with the inner gasket frame and additional low emission coating on the interior glass. The relevant surface heat fluxes are indicated (red coloured arrows). [W/m²] is used as unit for the heat flux's magnitude, inscribed beside the arrows.

The heat fluxes through the masonry were very similar in all concepts. Just for concept (C) with the integrated thermal insulation the heat flux from the masonry to the external environment was slightly lower. The heat fluxes through the shutter box were lower in the concept (C) and (D). The heat flux of the heater was varying because of the assumption of a constant heater surface temperature. A lower heat flux from the heater to the interior room indicates a better thermal protection of a modernization concept. Highest heat flux differences occurred for the BTW's casements and especially for the window glasses. In the concepts (A) and (B) the heat fluxes through the glasses were higher than 100 W/m², whereas they were in the range of 40 and 50 W/m² for concept (C). In the other concepts the heat flux value differed between 73 and 85 W/m².

9.1.7 Simulation based U-Values

For the U-value determination a sections of the origin simulation model were prepared. For the calculation of the BTW U-value the BTW and a small part of the exterior and interior were kept in the simulation geometry. For the U-value calculation of the whole façade with included BTW the model's top and bottom boundaries were limited to the ground and the ceiling surface of the interior room.

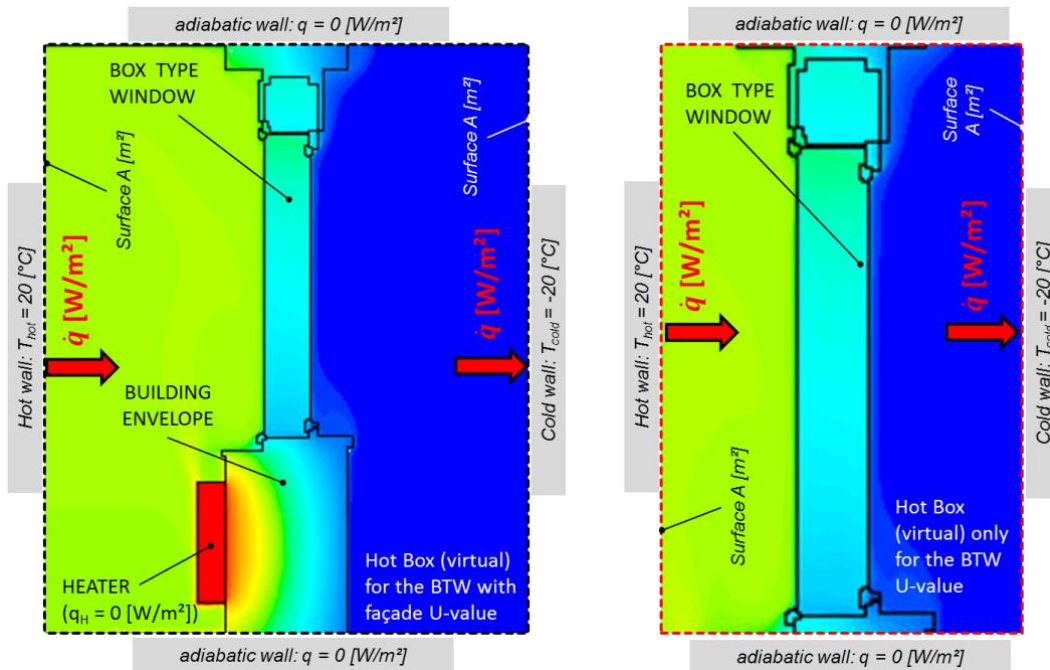

Figure 37: Sections of the origin simulation geometry (Figure 23) which were used for the U value determination (virtual hot box).

These simulation models have four boundary surfaces left, with the following specifications:

- The left boundary was to a (interior room) temperature of 20 °C.
- The right boundary was set to a (external)temperature of -20 °C
- The heater is deactivated for the U-value determination ($q_H = 0 \text{ W/m}^2$).

Furthermore the U-value calculation requires, additional to the temperature difference (ΔT in [K]) between the left and the right boundary of the virtual hot box, adiabatic walls for the top and the bottom boundary. With these boundary conditions we receive the information about the heat transfer rate (q in W/m^2) from the left to the right boundary and are able to calculate the U value with the help of the Heat Transfer correlation:

$$\dot{Q} = U \cdot A \cdot \Delta T = U \cdot A \cdot (T_{hot} - T_{cold})$$

$$\dot{q} = U \cdot \Delta T = U \cdot (T_{hot} - T_{cold})$$

$$U = \frac{\dot{q}}{\Delta T}$$

- \dot{Q} heat flow [W]
- \dot{q} heat flux [W/m^2]
- ΔT temperature difference [K]
- T_{hot} temperature of the hot wall [K]
- T_{cold} temperature of the cold wall [K]

The calculated U-values are illustrated in Table 22:

Table 22: Calculated U values of the BTW as well as for the whole facade, differently renovated.

Renovation concepts		(A)	(B)	(C)	(D)	(E)	(F)	(G)
		refurbished	inner gasket frame	thermal insulated	additional interior casement	vertical airproof divider	(A) + low emission coating	(B) + low emission coating
BTW	U-values [W/(m ² *K)]	1.74	1.69	0.76	1.32	1.32	1.38	1.32
	heat flux [W/m ²]	78.1	76.2	34.2	59.2	59.4	62.0	59.4
Facade with BTW	U-values [W/(m ² *K)]	1.37	1.35	0.65	1.09	1.08	1.12	1.08
	heat flux [W/m ²]	61.6	60.5	29.2	48.8	48.6	50.5	48.6

With the U-value a ranking of the thermal performance for a cold winter day could be made. Based on the (A) refurbished BTW the U-value was reduced by 56% for the (C) integrated thermal insulation for the shutter box and the use of a thermal insulation glass for the interior casement. With the integration of an (D) additional interior casement or an (E) vertical airproof divider the U-value could be reduced by 24%, whereas an (B) gasket frame for the interior casement caused just a reduction in the U-value of approximately 3%. However the integration of a low emission coating for the interior glass (F and G) reduced the U-value by about 21%.

9.1.8 Acknowledgement

The simulations and measurements were accomplished within the research project "denkmalaktiv I" [24], funded by the "Austrian Klima- und Energiefonds" (www.klimafonds.gv.at) and the Austrian Ministry for Transport, Innovation and Technology (bmvit)

9.2 Internal thermal insulation

Stefan Holper, FIBAG
Michael Grobbauer, FIBAG
Peter Kautsch, TU Graz
Severin Zimmer, TU Graz
Ulrich Ruisinger, TU Graz

9.2.1 Introduction

Conventional thermal rehabilitation confronts planners and executors with problems at historical buildings. The application of typically used external thermal insulation can be unfeasible because of existing building lines, monumental protection of listed buildings or high efforts and costs. In these cases internal thermal insulation is an opportunity to still fulfil set targets on thermal protection.

These internal thermal insulation systems are formed either by systems with vapour barriers on the inside of the thermal insulation, insulation materials as vapour barriers itself (for example foam glass) or capillary active insulation systems. The latter solves the problem of moisture enrichment caused by vapour diffusion from the interior of the building by sorption and capillary transportation processes. The interaction of the system components (glue mortar, insulation material and plaster) allows re-drying of moisture through the insulation material to the interior of the building.

As known amongst experts, the functionality and basic suitability of many capillary active insulation systems are well known. But especially the component connections and construction details with complex interaction between internal insulation system and existing construction are less researched. The usage of internal insulation systems in specific projects depends on the suitability of exactly such construction details. General rules of construction at component connections are missing completely. Simple assessments with heat bridge catalogues are not possible because of the complex hygrothermal behaviour. Therefore every case has to be proved for ability separately.

The project denkmalaktiv takes a close look at a large variety of component connections and construction details, which are typical for historical buildings of the 19th and beginning 20th century. Different internal insulation systems, which are all already used on the market, are analysed. The general aim of the project is to prove the ability of these systems in combination with different construction details and provide recommendation for execution. A better understanding of the functionality and generalizable findings of the behaviour in connection with different construction details form the foundations for a systematization of internal insulation systems and give a possibility of using these systems without complex simulations.

9.2.2 Object of investigation

Internal thermal insulation systems

Many different thermal insulation systems are available for application on the inside of external walls. For this research, only already used systems with known material properties were chosen. The systems possess different hygrothermal properties and cover a wide variety of operating principles. All systems were modelled with manufacturer-compliant glue mortar and plaster in the prescribed thicknesses. This ensures the correct functionality of the systems. Due to the high requirements on energy demands of buildings, a general thickness of 12 cm of the thermal insulation was chosen.

The system iQ-Therm got modelled with 8 cm because no larger dimensions are available for this product. The system Calsitherm got modelled with 12 cm and also with 8 cm to provide a comparable alternative with lower thermal resistance.

- **System Calsitherm (CT 08 & 12)** - The thermal insulation consists of micro porous, open-pored calcium-silicate with a widely homogenous range of pore size. Calsitherm with 8 cm represents the system with the lowest thermal resistance.
- **System Multipor (MP12)** - The thermal insulation consists of hydrated calcium-foam. The range of pore size is inhomogeneous. Multipor with 12 cm shows the highest thermal resistance of all systems.
- **System Cellulose (ZL12)** - The thermal insulation consists of cellulose flakes which are sprayed on the wall. To compensate unevenness, which is caused by the application process, the inner plaster is thicker than of the other systems.
- **System iQ-Therm (iQ08)** - The thermal insulation consists of polyurethane foam with orthogonal orientated tubes filled with capillary active mineral mortar. Despite the thickness of 8 cm the system presents the second highest thermal resistance.

Table 23: Material properties of thermal insulation systems

Name	Comments	Layer	Thickness [cm]	λ [W/mK]	μ [-]	R [m ² K/W]	s_d [m]	R_{iis} [m ² K/W]	$s_{d,iis}$ [m]
Calsitherm CT12	calcium-silicate micro porous structure	Glue mortar	0,8	0,920	38,4	0,01	0,31	1,95	1,08
		Insulation	12,0	0,063	5,4	1,90	0,65		
		Inner plaster	1,0	0,282	12,1	0,04	0,12		
Calsitherm CT08	calcium-silicate micro porous structure	Glue mortar	0,8	0,920	38,4	0,01	0,31	1,31	0,86
		Insulation	8,0	0,063	5,4	1,27	0,43		
		Inner plaster	1,0	0,282	12,1	0,04	0,12		
Multipor MP12	hydrated calcium-foam inhomogeneous porosity	Glue mortar	0,8	0,192	13,1	0,04	0,10	2,95	1,04
		Insulation	12,0	0,042	6,7	2,86	0,80		
		Inner plaster	1,0	0,192	13,1	0,05	0,13		
Isocell-Cellulose ZL12	cellulose „sprayed on the wall“	Glue mortar	-	-	-	-	-	2,38	0,41
		Insulation	12,0	0,052	2,5	2,31	0,32		
		Inner plaster	1,5	0,225	6,2	0,07	0,09		
iQ-Therm iQ08	polyurethane foam with tubes of capillary active mineral plaster	Glue mortar	0,8	0,497	18,7	0,02	0,15	2,62	2,45
		Insulation	8,0	0,031	27,0	2,58	2,16		
		Inner plaster	1,0	0,479	13,9	0,02	0,14		

Construction details

As mentioned above different construction details have been chosen to analyse the behaviour of the internal thermal insulation systems regarding to these constructions. Therefore typical historical constructions were chosen which are recurrent in listed buildings. The selection was based on reference buildings in Graz whereby specific details of the building and construction period got abstracted to provide transferability and comparability. An important criterion for the selection process was the aim to get a great range of different construction details, not only regarding to geometrics and materials, but also to modelled climates such as unconditioned attic and cellar. Due to the fact of differing wall thicknesses in historical buildings, also different masonry sizes got modelled. Preliminary investigations were made to find circumstances (such as wall thickness, type of connection joint of inner insulation to subsequent construction or position of the window in the wall) which produce critical conditions to lower number of necessary simulations. All analysed construction details are summarized in Figure 38 and Figure 39.

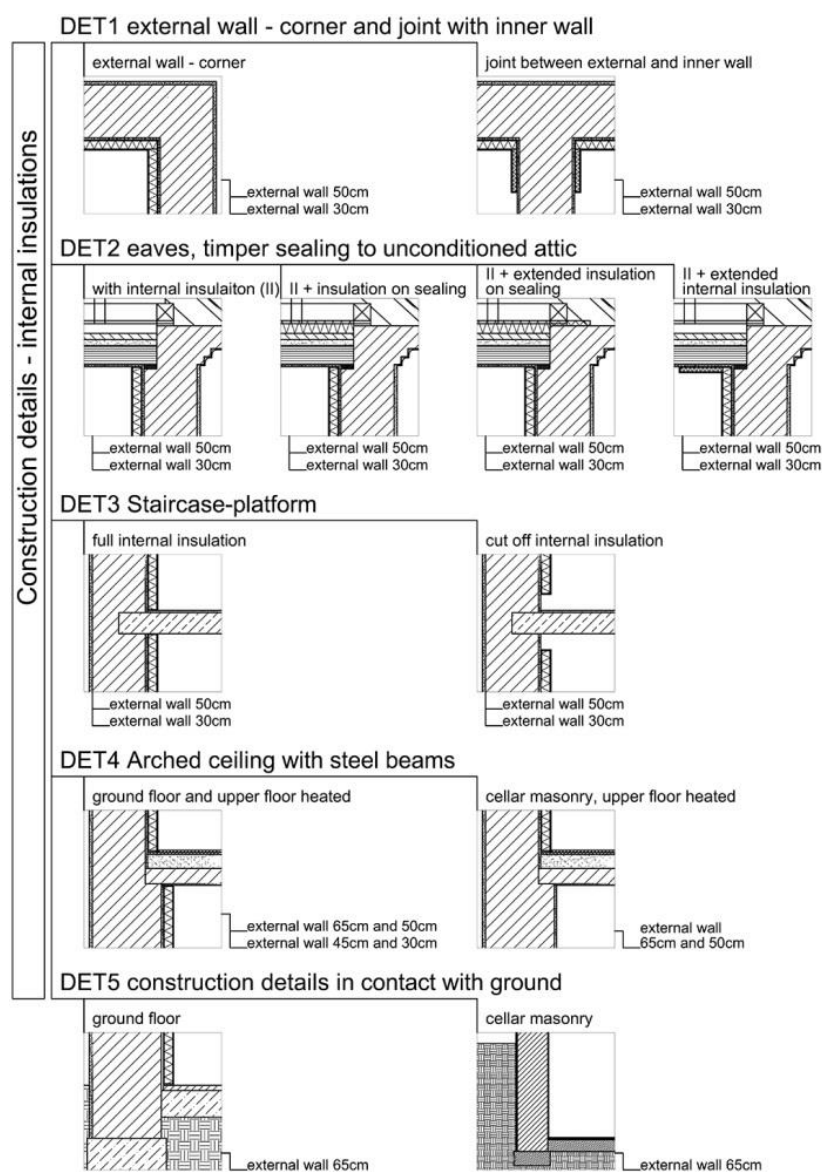

Figure 38: Construction details (part one)

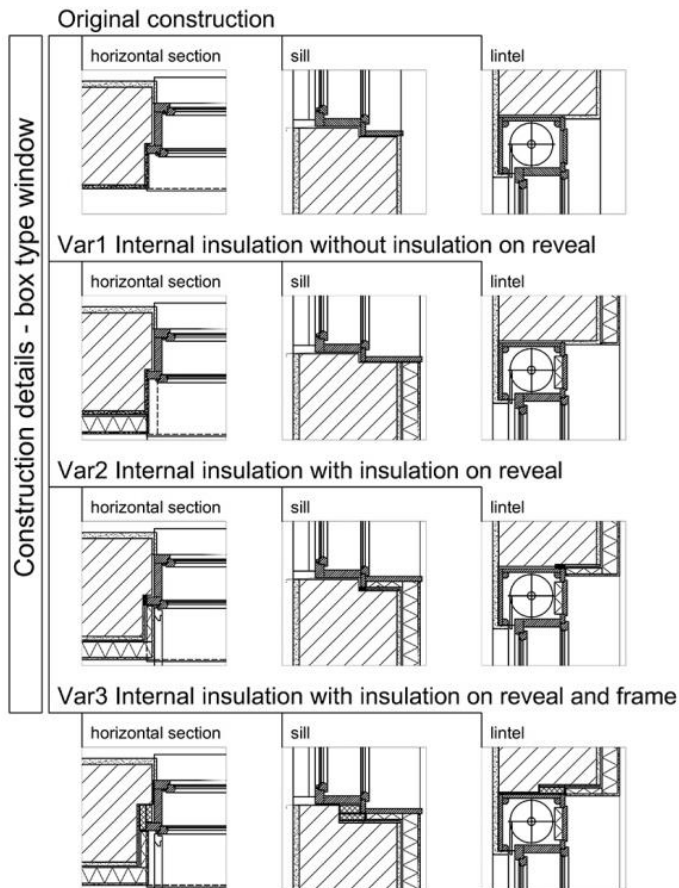

Figure 39: Construction details (part one)

9.2.3 Research method

For all kind of construction details the same approach was used. First, information was gathered for these construction details in literature and by examining existing buildings in Graz. With this information abstract constructions, which don't contain special details of architectural periods and are representative for a great range of buildings, got formed. Once the details were chosen, different variations of renovation were planned. These variations got analysed and pre-simulations were made to find out critical conditions and lower the number of necessary simulations.

The residual variations of construction details were object of detailed steady-state calculations with Heat2 (thermal calculations) and non-steady simulations with Delphin5 (hygro-thermal simulations). The calculations with Heat2 result into normative values for thermal transmittance (u -values), linear thermal transmittance (ψ -values) and temperature factors (f_{Rsi} -values). Delphin5 considers coupled heat and moisture transportation and displays temperatures, relative humidity and absolute humidity within the whole construction. Temperature and humidity fields at the day with lowest and highest water content got illustrated as well as yearly average values and extreme values. At locations of interest (for example where critical conditions had been expected) the temperature and relative humidity progression of a whole simulation year were illustrated to ensure correct assessment.

To prove the ability of the different insulation systems for application at the various construction details, investigations on the calculation and simulation results were made to meet the following limits:

- **Low temperature and mold growth on inner surface**

Mold growth is a risk for damaging the construction as well as a health risk for residents. Two models were used for the investigations. In steady-state calculations the ÖNORM B 8110-2 [27] limits the temperature factor on inner surfaces ($f_{Rsi} \geq 0,71$) to avoid critical surface humidity. This model is not usable for non-steady simulations. Therefore the model for mold growth by Viitanen [28] was used in hygrothermal simulations. The model considers growth and regression, the material on which growth happens and is based on hourly values of temperature and relative humidity.

- **Timber destruction**

Permanent high humidity in timber causes growth conditions for wood-destroying organisms. The EN 335-1 sets [29] the limit for the critical water content to 20 percent by mass (M%). To illustrate the risk of timber destruction in combination with re-drying effects another model by Viitanen [30] was used. The model shows the timber mass loss in M% for spruce and is based on hourly values of temperature and relative humidity.

- **Temperature and humidity inside the construction**

For analysing critical temperatures and humidity inside the constructions no dynamic models are available. ÖNORM B 8110-2 lists the following characteristics for critical water vapour condensate in one-dimensional systems:

- the condensate exceeds 0,5 kg/m² at non-absorbing materials
- the condensate decreases the thermal resistance of the construction by more than 10 %
- the condensate damages the building materials (corrosion, mold growth, frost)
- the mass related water content of timber and timber composites increases by more than 3 %
- the condensate doesn't re-dry during summer

- **Risk of frost**

External areas of the construction suffer from low temperatures due to the improvement of thermal resistance caused by the internal insulation systems. Therefore the risk of frost, ice formation and freeze-thaw repetition was analysed. Because of missing comparable data a validation couldn't be done.

9.2.4 Results

General findings at one-dimensional models

Normative calculations for vapour diffusion and prevention of condensate don't consider liquid water transportation. Therefore internal insulation systems, which are based on this functionality, show within these calculations high humidity enrichment during condensation periods. This leads to high water mass densities which can't totally re-dry during summer (

Table 24). Whereas unsteady hygrothermal simulations with Delphin 5 include liquid water transportation processes and therefore result into lower humidity enrichment. The results show good performance of all systems as already proved in practice. The systems themselves show diverging behaviours, which are caused by the different materials and the composition of the systems. All systems show the highest values of relative humidity at the layer between insulation system and masonry.

Table 24: Results of normative calculations and unsteady hygrothermal simulations

Insulation Systems	ÖNORM B 8110-2 (glaser method)		Simulation with Delphin5	
	Water mass density* [kg/m ²]	Re-drying during summer	Water mass density* [kg/m ²]	Re-drying during summer
CT12	2,194	No	-	Yes
MP12	1,846	No	-	Yes
ZL12	4,891	No	0,228	Yes
CT08	2,691	No	0,010	Yes
iQ08	0,599	Yes	-	Yes

*Water mass density of over-hygroscopic moisture at the end of the condensation period

At this layer the system Multipor presents during the whole simulation year values of relative humidity under 80 % whereas the other systems show maxima over 90 % (Figure 40). This is caused by the excellent liquid water conductivity of Multipor in the hygroscopic range of relative humidity. The hygroscopic range was defined with fewer than 95 % relative humidity. Condensate was defined with more than 99 % relative humidity.

With Calsitherm the relative humidity reaches in the condensation period the border of the hygroscopic range and re-dries during summer because of its high liquid water conductivity. The re-drying process is faster at the thinner system (CT08 with 8 cm thick insulation). The high water vapour diffusion resistance factor (μ -value) of the glue mortar seems to reduce the re-drying process.

The lowest water vapour diffusion resistance factor of the insulation material occurs at the system Cellulose. It shows therefore the fastest enrichment of humidity and the highest maxima of relative humidity of all systems. Nevertheless the great liquid water conductivity, especially in regions of high relative humidity (over-hygroscopic range), ensures the functionality of this system. Due to the long periods with over-hygroscopic humidity and the therefore occurring impact on timber destruction, metal corrosion or erosion of material components, further research should be done.

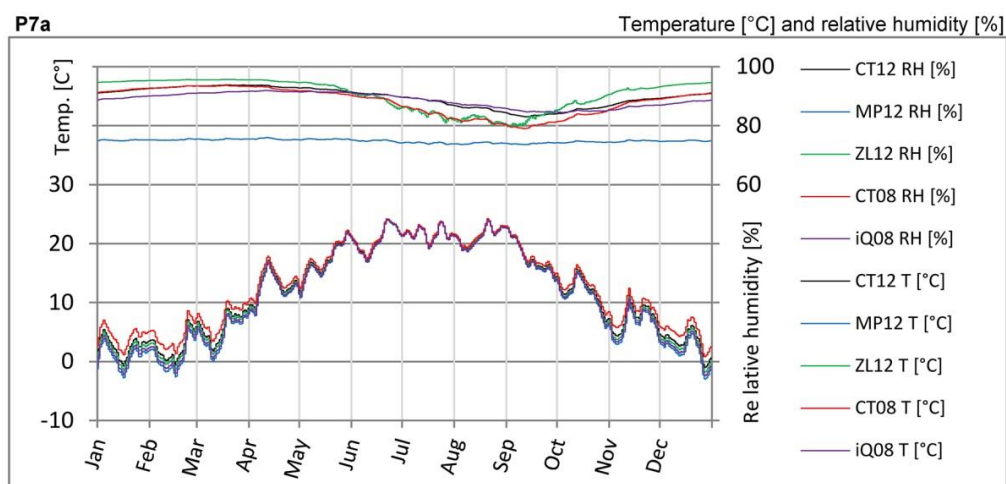

Figure 40: Temperature and relative humidity at the layer between insulation system and masonry

The insulation material of iQ-Therm presents the highest water vapour diffusion resistance factor and therefore minimises vapour diffusion into the construction. The mortar filled tubes enable the system to good liquid water transportation. The combination

of those properties results into reduced humidity enrichment and a slower re-drying process, compared to the other systems.

The results confirm the functionality of all systems. Multipor 12 and iQ-Therm 08 show the lowest total water mass, whereby Multipor 12 provides the lowest relative humidity. Furthermore both systems show the highest thermal resistance. All systems lead to temperatures below 0 °C in the whole masonry (Figure 40). Therefore the existing masonry itself, including the inner plaster, has to be frost-resistant, which often is not the case in historical buildings.

Suitability at construction details

Internal insulation systems and inner surfaces - At simple construction details with weak thermal bridges the surface temperature depends on the thermal resistance of the insulation system. At joints with stronger thermal bridges the heat transportation changes due to the thermal bridge. This is especially significant at the system iQ-Therm 08 because of the thin system (compared to the other systems) and the nevertheless high thermal resistance. The absolute humidity near the surface is not strongly influenced by the masonry or the insulation system because of the closeness to the internal climate. Therefore the relative humidity on the inner surface is mainly depending on the temperature and is high at intense thermal bridges in combination with insulation with high thermal resistance (especially Multipor and iQ-Therm). If joints include air-filled cavities which interrupt re-drying processes through adjacent structures, the effect gets slightly strengthened. General temperature-dependent sorption processes show only small influence and weren't analysed.

Internal insulation systems and construction components - If the construction detail includes relatively large external areas for drying (for example outside corner of external wall), systems with high water vapour diffusion resistance (like iQ-Therm) show a better behaviour. The reduced humidity enrichment faces a higher drying process towards the outer climate. Therefore in the inner corner between insulation system and masonry (outside corner of external wall) relative humidity is lower than at a one-dimensional wall segment.

At complex construction details with strong thermal bridges a high water vapour diffusion resistance and a low re-drying process are disadvantageous. At such construction details iQ-Therm 08 shows the same performance as Calsitherm 12. The stronger the thermal bridge, the more likely the different insulation systems behave the same way.

Internal insulation systems can also be applied on constructions with substantial thermal bridges such as concrete ceilings and staircase-platforms. Also the conditions on the inner surface at the thermal bridge may improve (higher temperature), compared to the situation without insulation system. An execution of a gap between thermal bridge and internal insulation has certainly negative influence because of dropping surface temperatures (for example staircase-platform, Figure 41).

At constructions with substantial thermal bridges the sequence of the insulation systems according to their internal surface temperature reverses. The systems with high thermal resistance (Multipor, iQ-Therm) show the lowest surface temperatures.

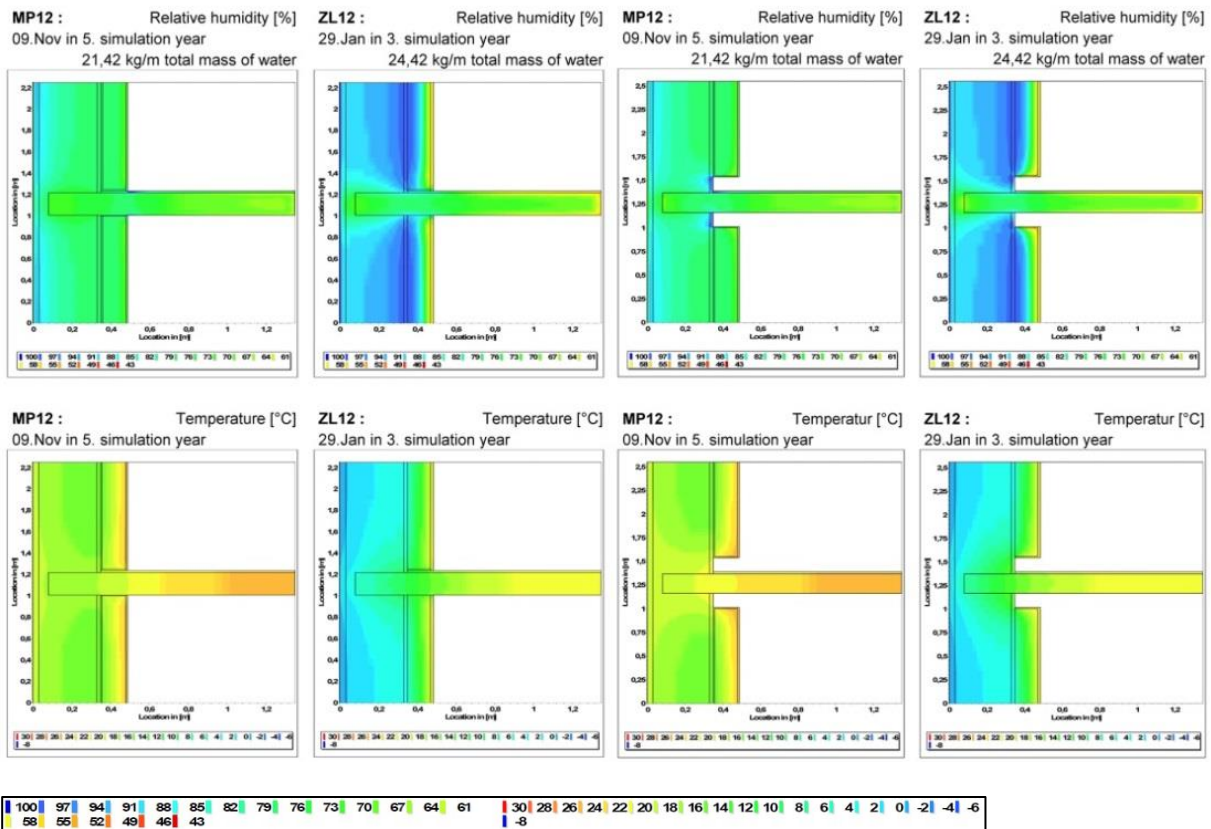

Figure 41: Relative humidity (upper charts) and temperature (lower charts) at joint between external wall and staircase-platform at the day with the highest total water mass; lefthand: full internal insulation system, righthand: 15 cm gap between insulation system and staircase-platform; Multipor 12 and Cellulose 12.

The reduction of heat loss by additional thermal insulation on the external side of construction details (for example thermal insulation on the floor of the attic) raises the temperature of the whole construction. Due to higher temperatures water transportation processes increase and relative humidity falls. Obvious systems with generally high humidity benefit more than systems with generally low humidity.

A solid wood ceiling contributes little to the overall water transportation processes. Therefore the re-drying process is lower in construction details like the eaves. Under such circumstances, systems with high liquid water conductivity near the over-hygroscopic range show better performance compared to the one-dimensional wall segment. Nevertheless all dry systems (with low total water mass) perform as good as usual.

Internal insulation systems can furthermore be applied on constructions with two bordering climates (for example attic or cellar) without concerns, but the danger of unpredictable circumstances rises at the inner corner of thermal bridges.

The combination of substantial thermal bridges with high humidity enrichment leads to borderline conditions. Thereby the humidity enrichment can also have origin from outside, as possible at construction details with contact to ground. The systems don't fail in the hygrothermal simulations but no additional negative influence is allowed to prevent a collapse. Applying internal insulation systems on such construction details is only possible with accompanying actions like humidity barriers or external insulation in the area of thermal bridges.

Internal insulation systems and box type windows

Calculations with models of the existing historical box type window (without internal insulation system) show at the masonry and window no critical relative humidity. Only at the internal edge of window and reveal temperature factors drop under the limit of the ÖNORM B 8110. Nevertheless the results of the unsteady simulations with Delphin5 show no danger of mold growth or condensate. This confirms the sufficient safety of normative calculations and the function of the box type window.

Compared to the conditions at the existing window, the masonry is cooling off with an internal insulation on the inside of the wall (without insulation on the reveal, Variation 1). Therefore also the surface temperatures at the reveal show low values, with the minimum near the edge of window frame to reveal, where a hotspot of relative humidity occurs. Because of re-drying effects at the reveal the absolute humidity in this area is not strongly influenced by the different insulation systems. The differences of the relative humidity are depending on the temperature which is lowest with the system Multipor 12 because of the highest thermal resistance of the systems. In fact there are only little differences in relative humidity between the internal insulation systems. Therefore no system emerges more critical than another system and no system fails (Figure 42).

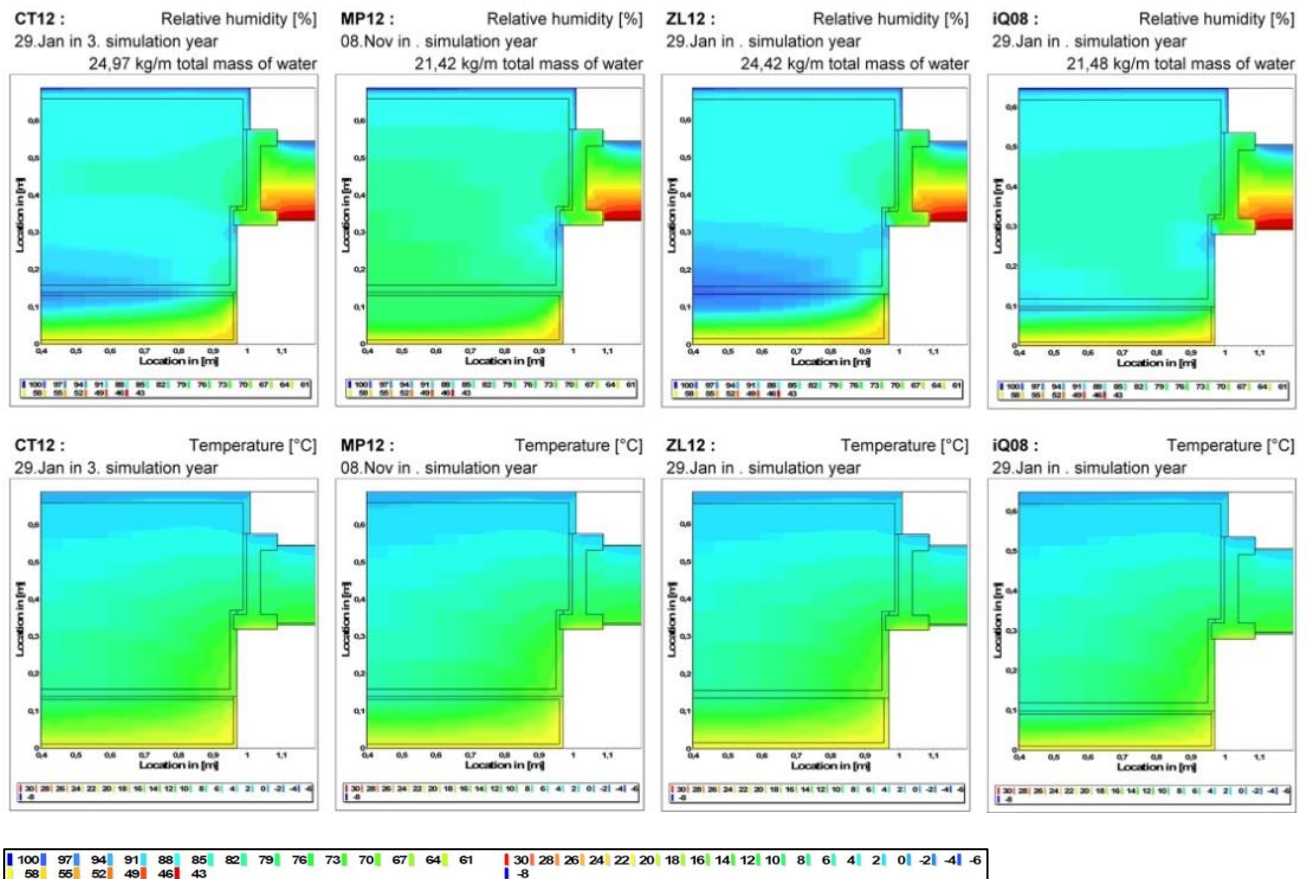

Figure 42: Relative humidity (upper charts) and temperature (lower charts) at the horizontal section of the box type window with internal insulation system (Variation 1) at the day with the highest total water mass; from the left to the right: Calsitherm 12, Multipor 12, Cellulose 12, iQ-Therm 08.

The models with additional 30 mm internal insulation on the reveal (same material as internal insulation system, Variation 2) show distinctive higher surface temperatures than in Variation 1 but don't reach the surface temperatures of the original structure. The insulation on the reveal generates between itself and the masonry the same behaviour as the system on the regular wall. Similar to Variation 1, a hotspot of relative humidity occurs at the edge of window frame to reveal. In the air cavity between window frame and

masonry the values of relative humidity drop too, which is caused by the lower vapour diffusion through the reveal with insulation. Summarized the situation improves with an additional internal insulation on the reveal and Variation 2 is fully functional.

Additional to the measures of Variation 2, in Variation 3 the air cavity between window frame and masonry gets widened and backfilled with polyurethane insulation. This additional insulation increases the temperature of the inner wooden frame and the nearby surface of the reveal. This area is already uncritical with the measures of Variation 2 (insulation on reveal), lowers therefore only the heat loss and improves comfort nearby the window because of higher surface temperatures.

At the described hotspot of relative humidity the values rise slightly because of the reduced humidity transportation within the area of polyurethane insulation but don't lead to critical values. The reduced re-drying effects toward the outside climate get compensated by the increased temperature. Despite of the high effort and costs, Variation 3 is recommendable even if Variation 2 already creates an uncritical situation.

9.2.4.1 Conclusions

The behaviour of the internal thermal insulation systems at the one-dimensional wall section got mostly confirmed at the two dimensional construction details.

Multipor shows in nearly all situations the lowest absolute and relative humidity (except inner surface at substantial thermal bridges). The combination of high liquid water conductivity and adequate water vapour diffusion resistance with a good coordination of the system components result in a predominant system.

iQ-Therm presents at most of the construction details the second lowest absolute humidity. Higher values of relative humidity are able with thermal bridges near the inside surface of the construction. Due to the thin insulation (8 cm) and a high thermal resistance the system is sensible for heat flows at joints on the side end of the insulation system.

Calsitherm has a high capability for water storage and a low liquid water conductivity in the range of high humidity. The liquid water conductivity is as high as in the system Multipor, which though never reaches this height of relative humidity. Also the water vapour diffusion resistance of the glue mortar contributes to the high humidity. Compared to the other systems the thermal resistance is low. Therefore temperatures at the layer between insulation system and masonry are comparatively high and, as a result, the relative humidity comparatively low. All in all, the values of relative humidity rank in the mid-range of the analysed systems. This general behaviour appears at nearly all construction details.

Cellulose presents a very good thermal resistance which results in low temperatures at the layer between internal insulation system and masonry. In combination with also low water vapour diffusion resistance this leads to high relative humidity, often in the range of over-hygroscopic humidity. Therefore the combination with humidity sensitive materials is generally critical. But the high liquid water conductivity ensures a reliable re-drying, which results in high yearly fluctuations of humidity.

The described disadvantages of the different systems lead at some construction details to borderline conditions. But every internal insulation system is suitable for the analysed construction details (except the construction details with connection to ground). Although because of stability and safety of the behaviour, the system Multipor is preferable, which moreover shows the highest thermal resistance.

9.2.5 Further research

The original aim, to start a catalogue of abstract construction details with requirements of internal insulation systems, couldn't be achieved, in spite of good distribution of construction details and a broad variety of characteristics within the different internal insulation systems. The behaviour is too complex and diverse, especially the behaviour due to the combination of internal insulation system and existing structures. Nevertheless the results show general regularities which have to be confirmed in further research.

All in all it doesn't seem to be possible to create a catalogue of construction details, but deeper investigations built on the results of this project enable to specify requirement of internal insulation systems for particular cases. Therefore differentiated research is necessary to systemize the interaction between thermal resistance, vapor permeability, sorption and liquid water conductivity of single material layers as well as whole systems. Construction details have to be reduced to their operating principle which is influenced by the geometrics, the behavior of the enclosed materials and the bordering climates.

In addition also the simulation tools have to improve their performance and provide comfort functions such as automatically post-processing of data. The used indices by Viitanen show unexpectedly uncritical results what raises concerns. The model has to get a critical appreciation and a confirmation of the broad scientific community.

In conclusion, further on simulations are still necessary to secure decisions on applications of internal insulation systems. But with continuing effort construction rules can be developed to confirm the suitability for certain construction details. Then a broad usage of internal insulation systems would be thinkable without detailed simulations. Even though for a certain construction detail the level of performance won't be definable, a general statement of failure or passing could be possible. At last it has to be mentioned that further research also can create a foundation for a valid standardization.

9.2.6 Acknowledgement

The simulations and measurements were accomplished within the research project "denkmalaktiv I" [24], funded by the "Austrian Klima- und Energiefonds" (www.klimafonds.gv.at) and the Austrian Ministry for Transport, Innovation and Technology (bmvit)

9.3 Model Based Predictive Control for Buildings Management Systems

Tarik Ferhatbegovic, AIT

Via coordinated, dynamic energy management of HVAC systems in non-residential buildings, essential energy savings for the actuating equipment (i.e.: heat pumps, pumps, valves, etc.) can be achieved. A systematic approach via mathematical modelling, model validation using measurements or standards, the design of the controllers and hardware-in-the-loop tests seem to be very promising within the frame of minimal invasive solutions for building management systems, see Figure 43.

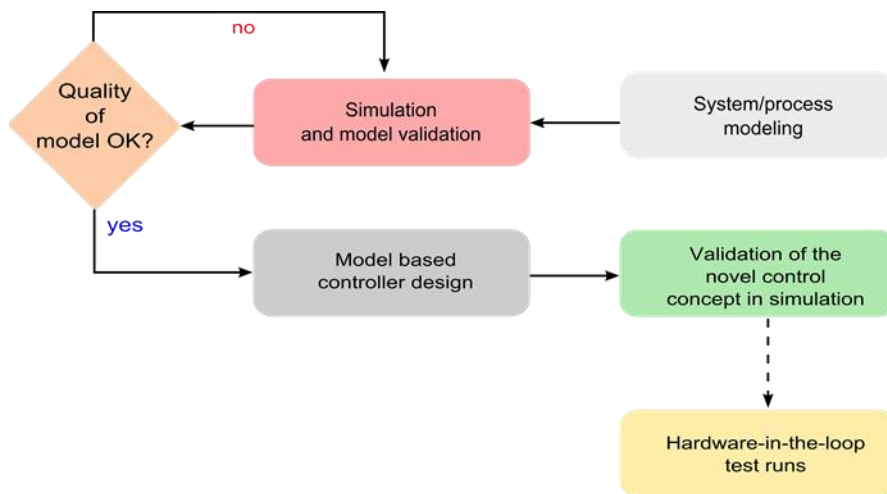

Figure 43: Coordinated design of innovative model based control solutions for building management systems.

Energy optimality for HVAC system operation is a crucial aspect. Thru better and more coordinated controls, energy efficiency can be pursued effectively. As a matter of fact most conventional controls base upon empirical standards and usually do not take the energy efficient system operation into account. Therefore it is required to introduce concepts which take the thermodynamics of HVAC systems into account and fully exploit their potentials with respect to the energy consumption. For this purpose, the model predictive control approach proves to be the means of choice. Not only that it allows for the definition of the control goals which aim at the increase of the energy efficient operation of the controlled systems, it also incorporates predictions of HVAC system behaviour for defined time horizons within which the optimization is performed.

Figure 44 illustrates the envisaged concept for the coordinated and dynamic energy management in building controls. The local control loops (for heating, cooling and air-conditioning circuits) are superimposed with a model based energy management, where the underlying local controllers are run in an optimal way (e.g.: via re-scheduling for open-loop control and dynamic adaptation of desired values for continuous closed-loop controllers).

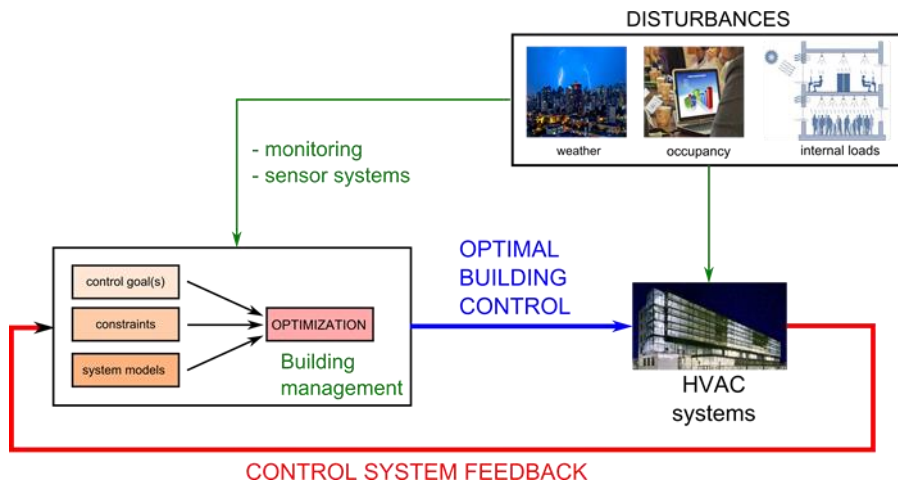

Figure 44: Concept for incorporating model based control in building management systems. Model based predictive control includes the definition of control goals, specific system constraints as well as the mathematical formulation of the HVAC system behaviour.

Model predictive control including information about disturbances (i.e.: weather, occupancy, internal loads, etc.) acting on the system proves best for performing online optimization (i.e.: energy optimality, power optimality, time optimality, etc.). The control goal is mathematically formulated as a (nonlinear) optimization problem.

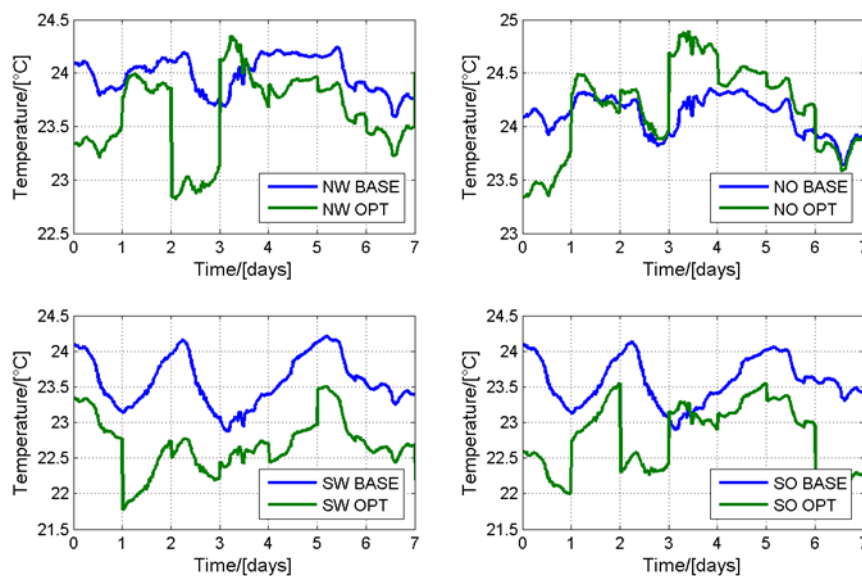

Figure 45: Coordinated model based predictive energy management for building management systems.

The easiest way of performing model based energy management is by accessing the conventional controls and “leading” the subordinated local controllers in an optimal way. Figure 45 illustrates the approach of incorporating model based energy management in a non-residential building via coordinated, dynamic set-point adaptation of the concrete core activation system for four zones (north-east, north-west, south-east, south-west).

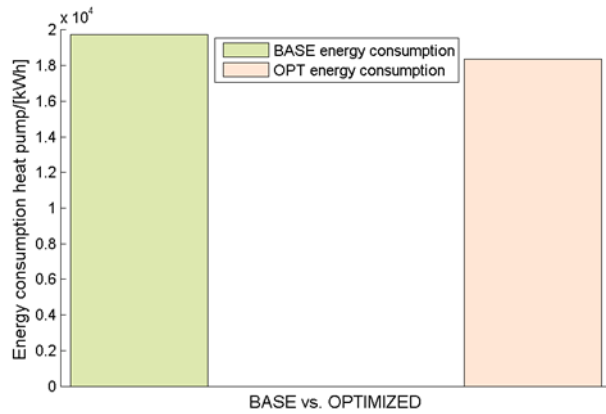

Figure 46: Energy consumption for the heat pumps of a heating circuit in a non-residential building: conventional (BASE) vs. optimized (OPT) energy management.

Figure 46 proves the concept for the optimal energy management via systematic and dynamic set-point shifting of concrete core activation desired temperatures. Apparently approx. 10% can be saved for the concrete HVAC configuration under given weather conditions (note: a heat pump serves as the critical actuator in this case). The minimal invasive measure allows for the increase of the energy efficient HVAC operation with no extra hardware effort.

9.4 Heat Pump systems for non-residential buildings

Simon Winiger, Fraunhofer ISE
Doreen Kalz, Fraunhofer ISE

In this overview 20 non-residential buildings equipped with heat-pump systems are compared. The objective of the comparison is to gain knowledge about the advantages and disadvantages of the different supply systems. The know-how acquired through the analysis and cross-comparison will be used for more efficient heat-pump systems in non-residential buildings in the future. The analysed buildings differ in the occupancy and use as well as in their total conditioned area and the hydraulic concepts applied. The comparison includes schools, offices, production halls, museums and gymnasiums with a total conditioned area between 870 and 17,400 m². The rated heating capacity of the heat pumps is between 14 and 291 kW_{th}. The complexity, from very simple to very complex, of the hydraulic systems correlates with the heating capacity of the heat pump and the conditioned area. The main information about the analysed systems is summarised in Table 25.

Table 25: Main information about the buildings in which the analyzed heat pump systems are applied. Retrofitted buildings (r).

	use	completion of refurbishment	total conditioned area [m ²]	net floor area	rated heating capacity of heat pump [kW _{therm}]
W01	school	2004	10,650	15,383	2x135
W02	production	2004	4,315	4,623	54
W03	office	-	1,560	1,609	75
G01	office	2002	2,076	2,151	57
G04	office, printing office	2005, r	1,110	1,390	33
G05	office, laboratory	2008	4,130	6,680	130
G06	office	2007	-	4,878	2x80
G07	production, office	2006	875	-	2x7
G08	office	2009	17,380	BGF:19,500	322
G09	office	2008	3,313	4,527	75
G10	Office	2008	2,000	2,500	68
G11	Office	2007	1,800	2,264	64
G12	school	2009	2,182	-	40
G13	office, detention rooms, workshop	2005	-	-	167
G14	office	2003	-	-	107
T01	museum/shop	2005	3,214	-	110

T02	school, r	2011	4,440	-	2x35
T03	gymnastic hall	2009	-	1,600	37
T04	school	2010	-	988	37.6
T05	-	-	-	-	6x38,8

For clustering the systems in different groups differentiation criterions are used. The systems are divided into two groups depending on the operating power. 15 out of the 20 considered heat pump systems are driven by electricity and five by thermal energy. Another criterion is the energy source and energy sink; 17 systems use the ground, the others use groundwater. A further criterion is the operation mode of the heat pump. One third of the analysed heat pumps are so-called reversible heat pumps, which means that they can supply heat during the heating season and cold during summer. Four of these reversible heat pumps are compact boxes with two exits on the secondary side. These heat pumps are able to provide cold and heat at the same time by using two different distribution strings. The differentiation of the analysed heat pump systems is shown in Figure 47. The focus is on differentiation by the operation mode. The figure also contains information about the thermal power and COPs of the analysed systems.

For further comparison the heating and cooling mode are differentiated. In the heating mode most systems (13 of 20 systems) operate bivalent and use waste heat, district heat, solar collectors, combined heat and power units, wood pellet-fired or gas-condensing boilers to meet the heating demand. The rated heating capacity of the supporting systems is between 45 and 592 kW_{th} and they cover between 29 and 90 % of the heating demand.

Almost all heat pump systems (19 out of 20) have heat storages to buffer the heat capacity provided. The heat storages are integrated in the secondary heat circuit in different ways. In twelve systems the heat storage is connected in series to the load. In the other seven cases the storage is integrated parallel to the heat circuit. Furthermore the heat storages differ in kind of construction and in size. There are simple storages which are supplied by the distribution string and so-called shared storages which are additionally supplied directly by an additional heat supplier. 75 % of the storages are simple storages and only 25 % are shared storages. Furthermore, there is one system with two combined heat and cold storages. The volume ranges from 500 to 6,141 litres.

Another criterion to distinguish between the systems is the kind of load connection. In four cases a part of the demand load is directly connected to the heat pump, which means it does not pass the heat storage. In the other cases the total load is connected to the storage. Besides, the connected load has different variable supply temperatures. All except two heat pumps are operated with low supply temperatures below 40 °C for concrete core conditioning and floor heating. In eight cases also high supply temperatures are provided for radiators and domestic hot water. In these cases the heat pump provides water with a high supply temperature which is mixed with the colder returning water for the low temperature distribution systems. The differentiation by the different storage types and hydraulic connections is shown in Figure 48. The figure also contains information about the thermal power and COPs of the analysed systems. Two of the analysed heat pump systems are installed in retrofitted buildings.

Not all buildings have a cooling system. Two buildings use the heat pumps only for heating; the others use the borehole heat exchangers, ground water wells or energy piles for free cooling and regeneration of the soil. Additionally, nine buildings use the reversible heat pump for active cooling as mentioned above. In four cases other sources for the cold supply are included in the cooling system, e.g. district cold, ambient air and conven-

tional compression refrigeration systems. Three buildings use separate cooling systems for conditioning the indoor climate.

Similarly to the heating mode, the cold supply systems include storages; in total five buildings have a cold storage. Four out of the five are connected parallel to the load and one is connected in series. The volume ranges from 950 to 4,000 litres. The cold water circuit supplies concrete core conditioning, radiant floor conditioning systems and active cooling systems for server rooms.

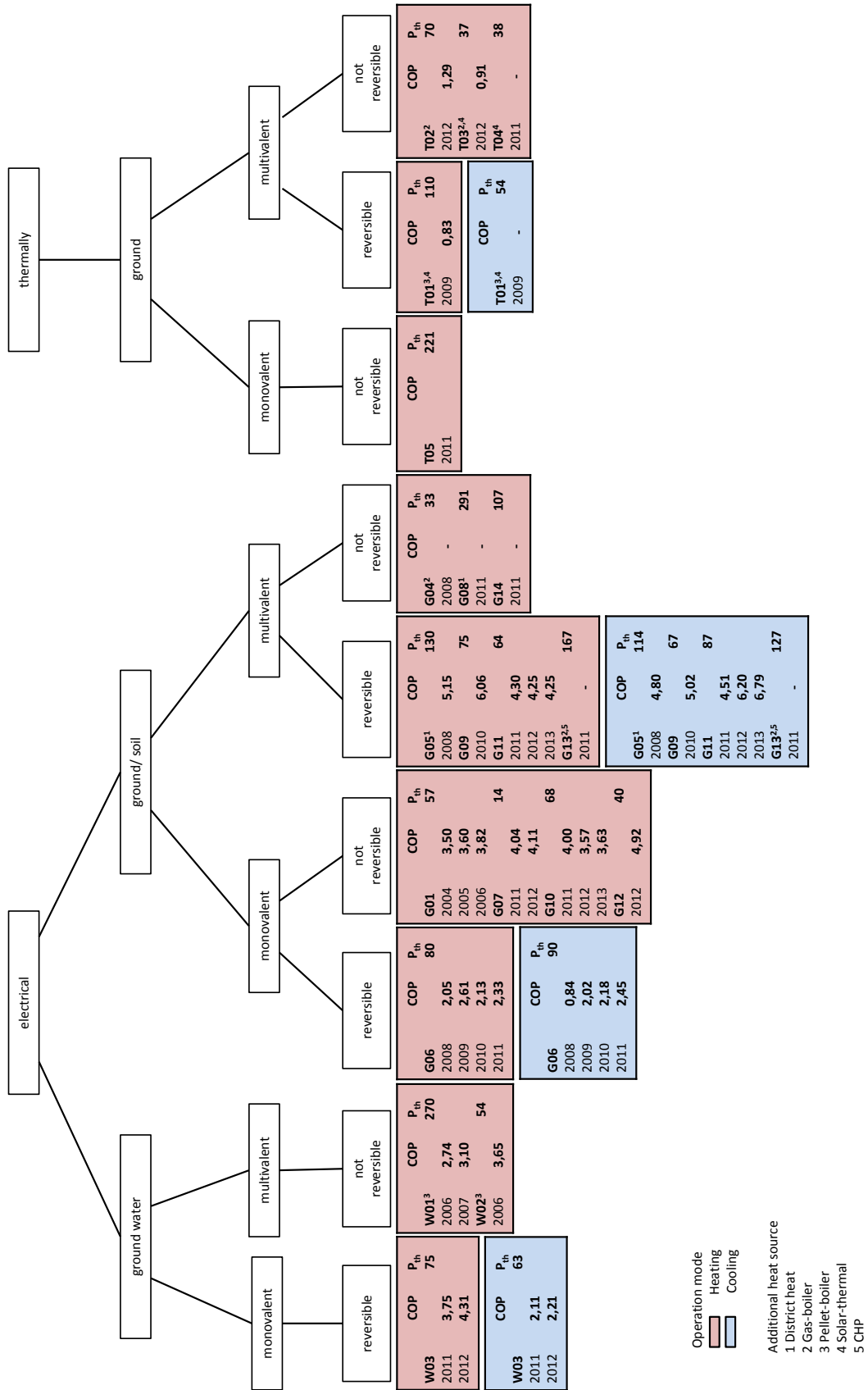

Figure 47: Analysed heat pump systems differentiated by the operation mode.

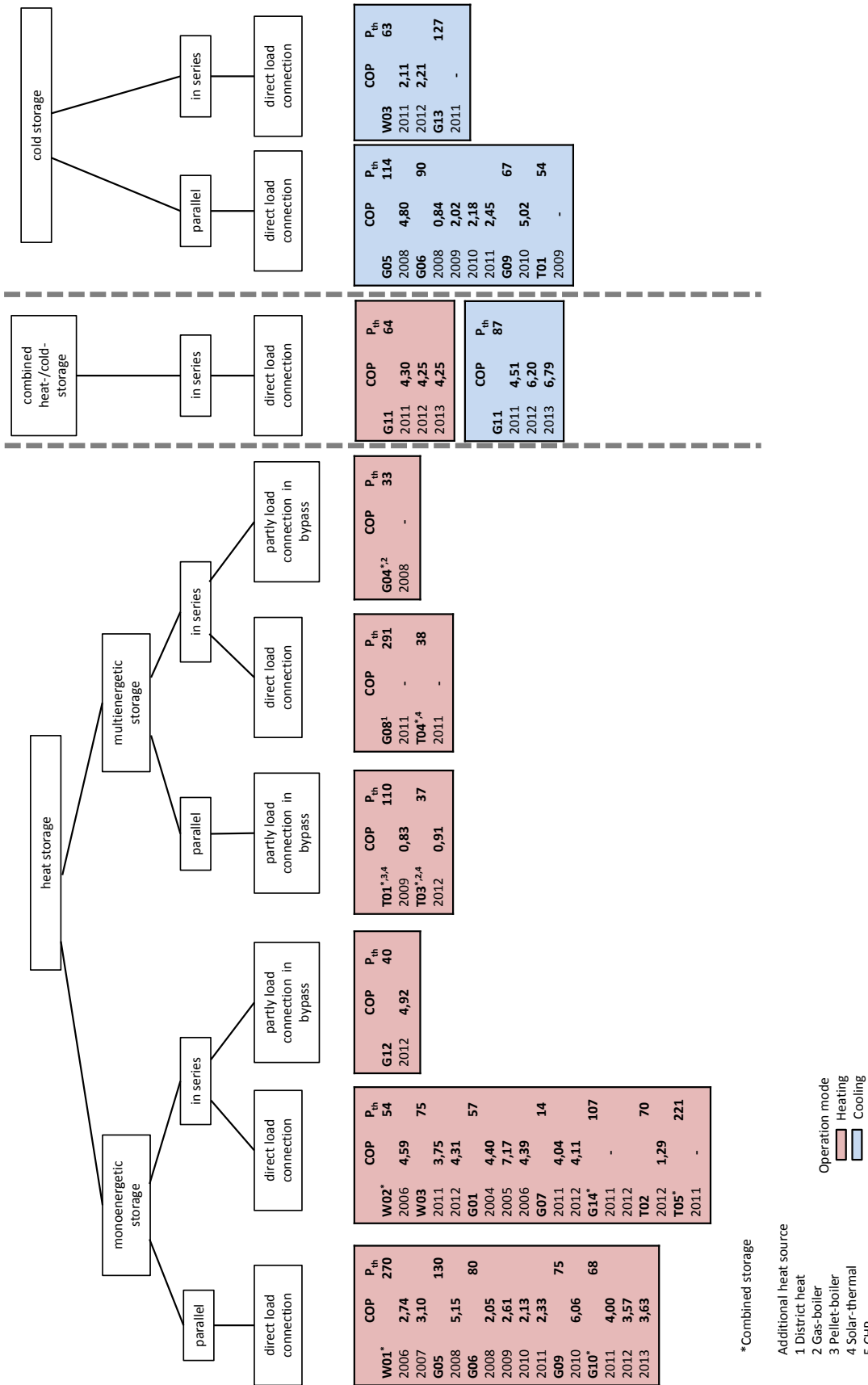

Figure 48: Analysed heat pump systems differentiated by the storage type and storage and hydraulic connection.

9.5 Prefabricated Façade

Fabien Coydon, Fraunhofer ISE
Arnulf Dinkel, Fraunhofer ISE

For reaching the CO₂ emissions reduction targets of the EU, the energy retrofit rate has to be increased two to three times compared to the current rate in Germany. One of the main reasons for the low retrofit rate is the high cost of an ambitious retrofit including the insulation of outside walls, the roof and floor as well as a replacement of windows and heating devices and the installation of ventilation systems. Furthermore, the buildings cannot be used at least for some time during the retrofit. In several European countries it is mandatory to install mechanical ventilation systems when more than one third of the window area is replaced, like in Germany, where the DIN 1946-6 [31] imposes the installation in residential buildings and dwellings since 2009. Prefabrication and semi-prefabrication of façades as well as the integration of ventilation systems in the façade are possible solutions for the cost reduction and the simplification of the mounting. The main difference between prefabrication and semi-prefabrication is that semi-prefabricated facades with integrated technical building services (e.g. HVAC-systems) consist of small scale elements, which do not cover the whole façade [32]. The elements systematically include window frames in order to improve the quality of the critical connection of window frames and façade insulation. The technical difficulties can be easily solved by prefabrication [32]. The remaining part of the façade, i.e. the area between the prefabricated elements including the technical services, is treated on a traditional way. One of the main advantages of semi-prefabrication compared to prefabrication is that the elements are smaller, can be assembled individually and thereby used at many different buildings, which makes mass production (cost reduction) possible. On the other hand completely prefabricated facades have to be designed individually for each building and lower the cost reduction possibilities through industrial mass production. The main advantages of prefabrication and semi-prefabrication are summarized in Table 26.

Table 26: The advantages of semi-prefabrication compared to complete prefabrication of facades [32].

	Prefabrication	Semi-prefabrication
Logistics	Difficulties to bring large elements to the construction site	Transport of small elements is easier
Manipulation	Use of scaffolds not always possible	Small elements easy to manipulate through scaffolds
Solidity	Frame, mostly timber based, necessary to provide rigidity to the panels	Rigidity of the insulation material often high enough to insure the solidity of the panels
Fixation on the façade	Fixation tracks or brackets necessary to support heavy weight of large elements	Small elements easier to fix to the façade
Connections between panels	High precision level required to avoid gaps between elements	Precise link between each element easy to obtain
Repetition of the process	Each panel must be designed to be used on one particular façade of one building.	A same sort of panel can be used on many different buildings

9.5.2 Integration of ventilation ducts

The integration of ventilation systems in the façade is one solution to avoid cumbersome air ducts inside dwellings, simplifies the work by avoiding core holes and allows using the rooms during the work [34]. A drawback of the installation of air ducts in external walls is the increased heat loss of exhaust and supply airflows which leads to reduced heat recovery potentials as shown in a study of the Fraunhofer Institute for Building Physics about a similar integration concept as introduced in the following [33]. The prefabrication of façade elements with an integrated ventilation system was demonstrated in a retrofit project in 2012 at the Fraunhofer Institute for Solar Energy Systems ISE in Freiburg Germany (see building GER04: Office and workshop building, Freiburg, page 43).

The façade concept is based on insulation boards consisting of standard EPS material in which air ducts can be clipped-in easily [34]. The insulation boards are mounted onto the façade and afterwards the air ducts are installed and covered by a second insulation layer. These systems allow a fast and replicable installation as the air ducts are integrated in a given structure. The structured first layer allows clipping-in the pipes horizontally or vertically in prepared channels [34]. The façade elements with the prepared channels are connected to prefabricated window modules, which include air inlets and roller shutters. The integration of the air inlets in the window modules avoids the need for core holes. The retrofit concept and the façade of the demonstration building after the retrofit can be seen in Figure 50. The panels cover the façade of six offices in the second floor of the building and the air handling unit is installed in a separate container outside of the building (see Figure 49).

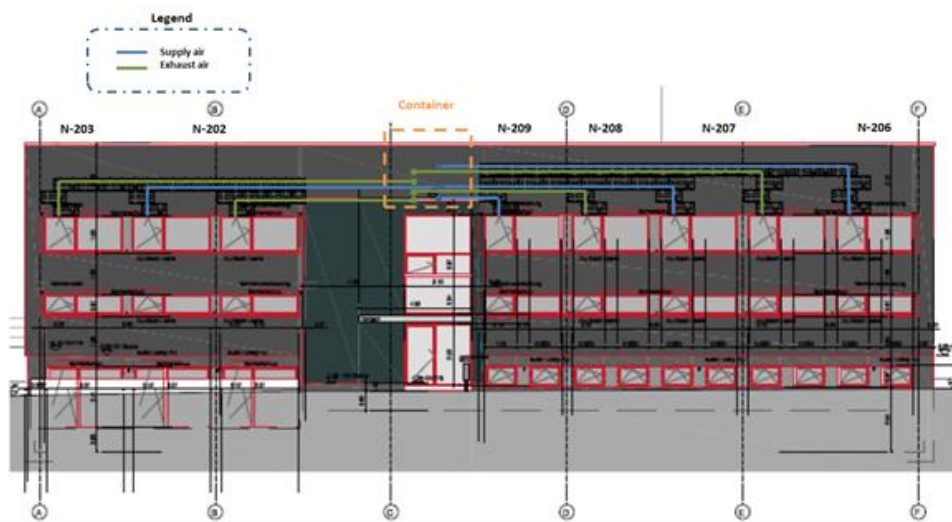

Figure 49: Façade with air duct paths.



Figure 50: Retrofitted façade of the demonstration building GER04, façade and window elements for the integration of the ventilation system and building during construction [34].

9.5.3 Monitoring and efficiency analysis

In order to analyze the efficiency of façade integrated ventilation systems based on DIN EN 308 [35] and the heat losses, a monitoring was carried out. Therefore, temperature and humidity sensors were installed at strategic points of the system, namely in- and outlets of the ventilation device and the air ducts [34]. Furthermore, the airflows and the electricity consumption were monitored. The monitoring concept is illustrated in Figure 51. With the monitoring concept it was possible to evaluate and compare the efficiency of (i) the ventilation device with heat recovery, (ii) the ventilation system with the air ducts (considering the heat losses of the ducts) and (iii) the global efficiency, which also considers that the heat losses of the ducts is partly regained by the reduction of the losses through the wall. The results are plotted in Figure 52. The efficiency of the ventilation device with heat recovery (incl. the electricity consumption) is around 85 %. This efficiency is reduced by the heat losses of the ducts to around 65 %. The global efficiency is around 75 % (compare [34]).

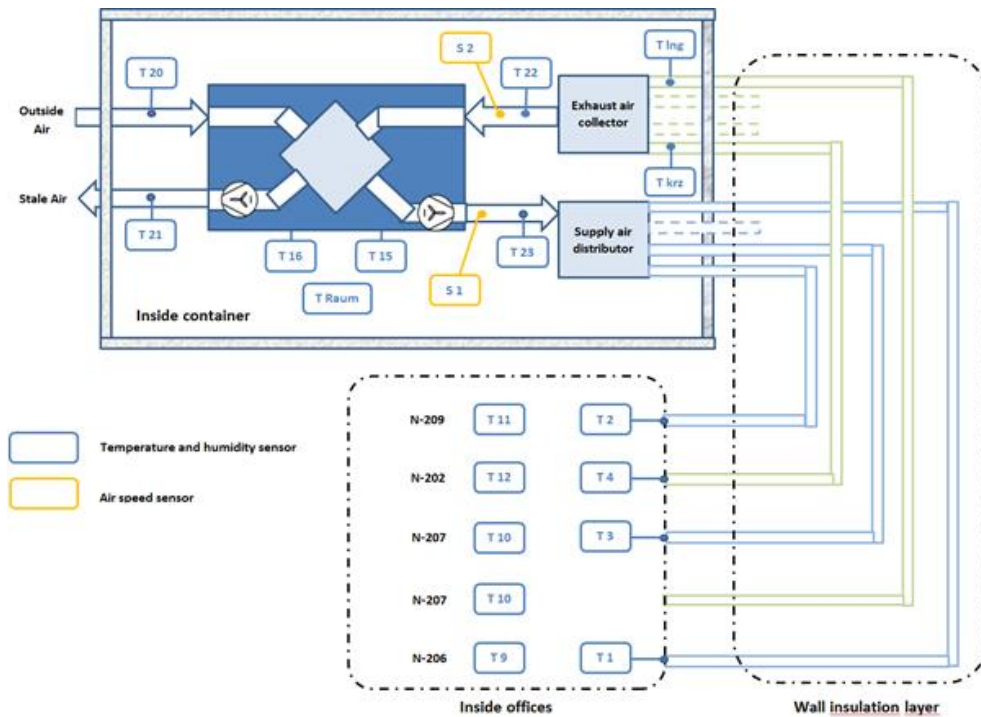

Figure 51: Monitoring concept for the façade integrated ventilation system in the building GER04 [34].

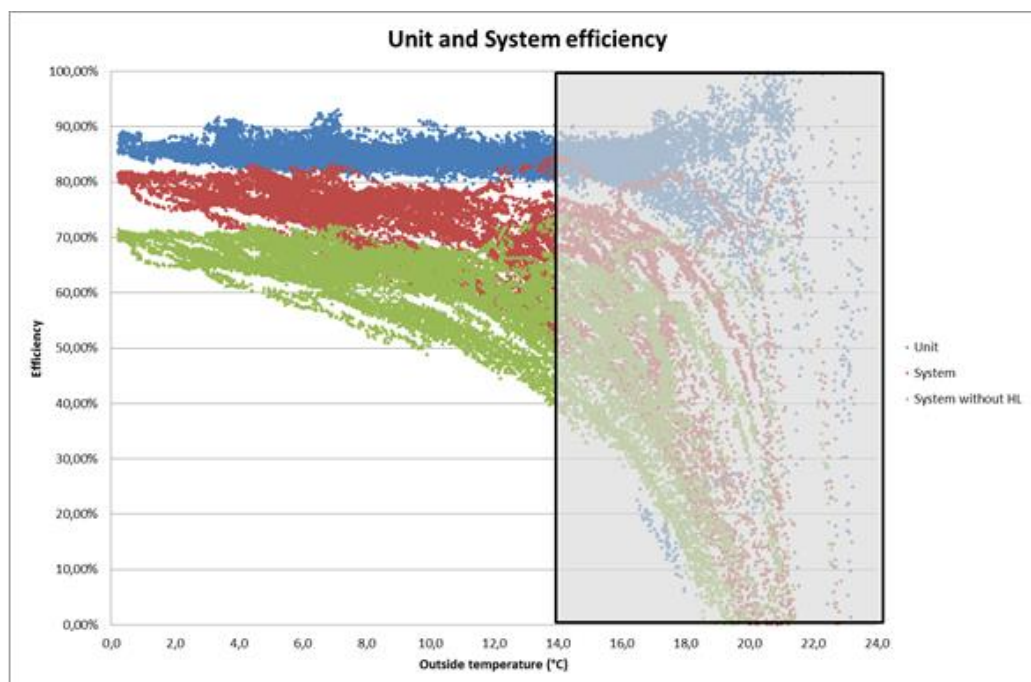

Figure 52: Efficiency of the ventilation system based on the monitoring results [34].

9.5.4 Optimization and further steps

In order to optimize the ventilation concept and minimize the heat losses, a numerical simulation model was developed at Fraunhofer ISE. One of the driving factors for the reduction of heat losses is the position of the air ducts in the insulation layer(s). The closer to the existing wall the ducts are, the thicker the second insulation layer can be which reduces the heat losses. But the first insulation layer has to be thick enough to resist the working conditions at construction sites [34]. For a new demonstration building in Frank-

furt, Germany, the position of the air ducts has been optimized and changed with the restriction that the total insulation can only be 160 mm. The previous and new layer configuration, as well as the temperature gradient in the insulation is illustrated in Figure 53. Simulations have shown that the temperature difference between in- and outlet of the ventilation ducts can be reduced by up to 2 K when the thickness of the first layer (which includes the ventilation ducts) is reduced from 100 to 70 mm [34]. With the new design the aim is to reduce the efficiency loss of 10 percentage points as it was monitored at the Fraunhofer ISE to less than 4 percentage points.

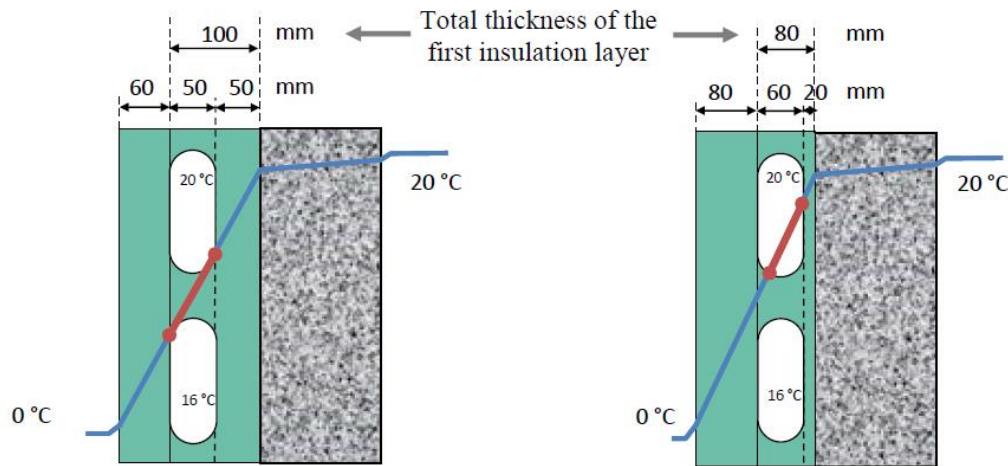

Figure 53: Previous (left) and new (right) configuration of layer thicknesses [34].

The integration of ventilation ducts in prefabricated façade and window elements is a promising solution to lower the costs of retrofit measures and thereby increasing the renovation rate. Furthermore, it makes the installation easier and the buildings can be used during the retrofit measures as almost no work has to be done inside the buildings as it would be the case if conventional ventilation system would be installed. The new concept with a thinner first insulation layer will be installed at a demonstration building in Frankfurt. The system will be monitored as well in order to confirm the simulation results and further improve the concept of prefabricated façade and window elements including ventilation systems. The integration of further building infrastructure like e.g. heating pipes is currently investigated and might be another option to make retrofit measures easier to carry out and cheaper.

9.6 Daylighting technologies

Kirsten Engelsing Thomsen, AAU
Jørgen Rose, AAU

9.6.1 Osram Culture Centre, Copenhagen, Denmark

The challenge was to energy renovate a former industrial building, now in use as culture centre, among other things by utilizing daylight and natural ventilation to improve the indoor climate.

In connection with the Climate Change Conference in 2009, the City of Copenhagen initiated a strategic cooperation with a number of Danish enterprises for the purpose of mutual profiling on climate-friendly buildings. The target was to minimize the resources required (and, consequently, the CO₂ emission) both during construction and upkeep. The renovation of the OSRAM Culture Centre was a part of this cooperation and acted as a spearhead for possibilities and methods of renovating old industrial and commercial buildings worth preserving.

The project is based on a new and more appropriate lay-out of the ground floor. There are two main entrances; the new one from the garden including the gate in the access/escape route. In the large entrance hall penetration of the ceiling will create double room height in part of the room. From the entrance hall a passage along the street facade gives access to two large flex rooms and three smaller activity rooms.

The large rooms open towards the garden and the activity rooms have glazing high in the walls allowing "used" daylight to enter, but prohibiting glimpsing from the other rooms. Lavatories and a bathroom are located in the eastern corner. In the southern corner there is an office facing the garden and new window slits to the gateway.

This lay-out of the building presents several advantages. The passage along the facade is a partly heated room, which will reduce the heat loss through the facade. As this facade is symbolizing the house architectonically, it would be hard to reinsulate it without damaging the present expression. By using a room high double wall of energy efficient glass instead of adding external insulation to the wall, the architectonic expression will be maintained and the heat loss reduced, though somewhat less than what could have been achieved by the external insulation.

On the first floor the present lay-out is maintained apart from the area around the front stairs where it is now possible to look towards and communicate with the entrance hall and the passage downstairs.

On the first floor there is access to the great hall and the three offices making up the primary rooms on this floor. Roof windows are installed above the great hall, the offices and the hallway and fitted with electrically operated sun screening and opening devices for natural ventilation.

The roof windows in the hallway will contribute highly to creating a lighter and more inviting entrance area and to make the passage more open. The windows in the great hall are relatively small and the roof windows will improve the daylight conditions considerably in this area. At the same time the roof windows will contribute actively to adjust the indoor climate when a lot of people are gathered for activities like folk dance, lectures and private parties.

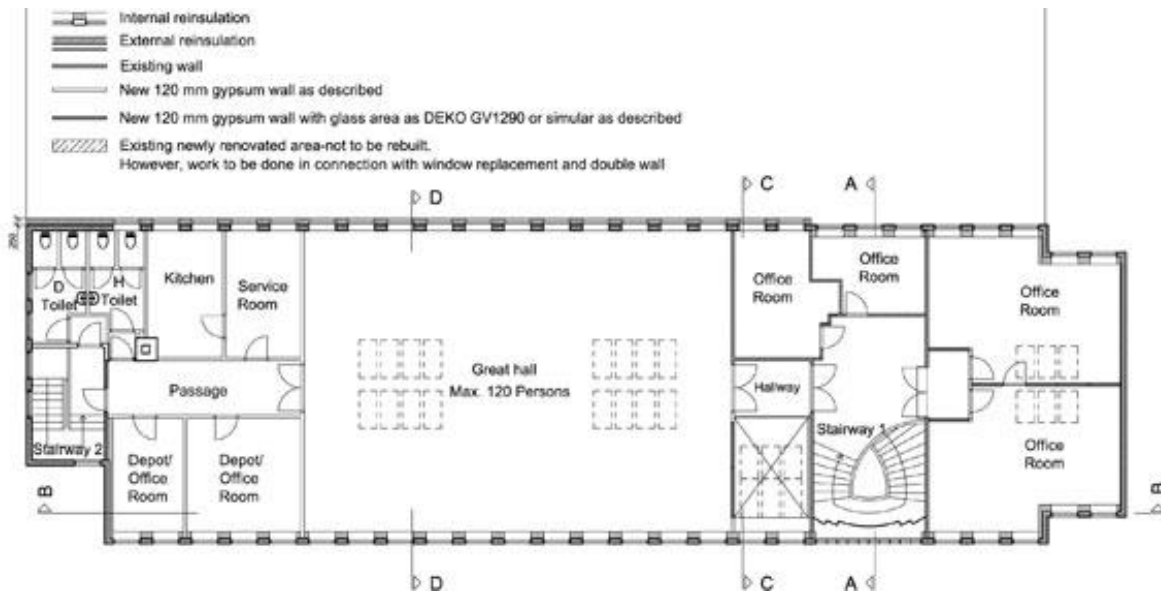

Figure 54: First floor layout.

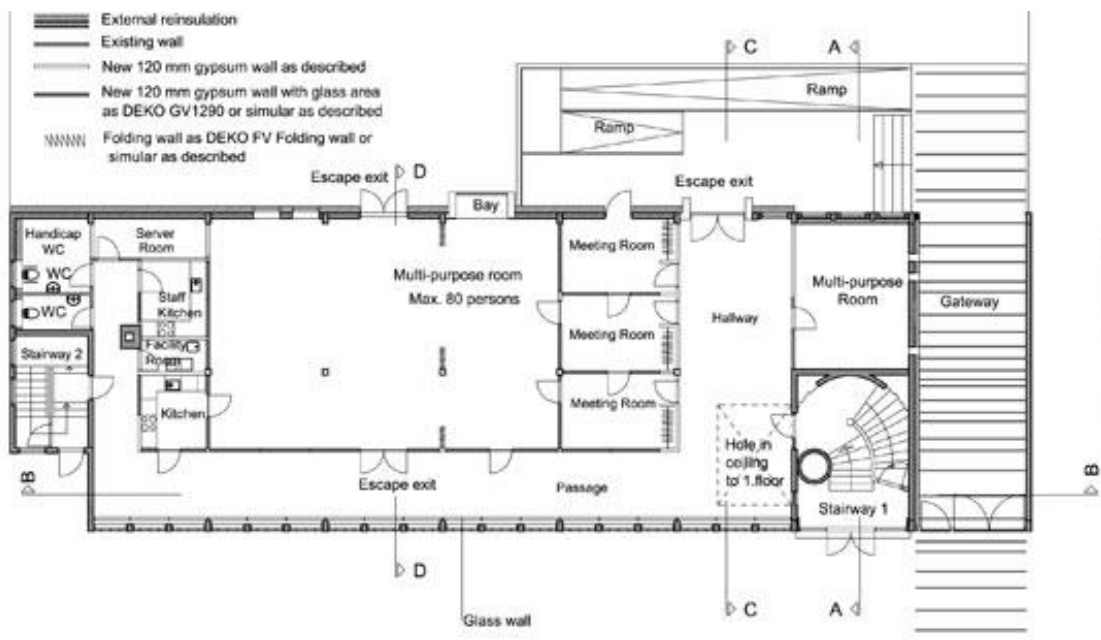

Figure 55: Ground floor layout.

The daylighting performance of the OSRAM Culture Centre has been specified using the daylight factor (DF) as performance indicator.

The daylight factor is a common and easy to use measure for the available amount of daylight in a room. It expresses the percentage of daylight available in the interiors, on a work plane, compared to the amount of daylight available at the exterior of the building under known overcast sky conditions. The higher the DF, the more daylight is available in the room. Rooms with an average DF of 2 % or more are considered daylight. A room will appear strongly daylight when the average DF is above 5 %.

The daylight factor analysis has been performed using computer simulations of Radiance. The figures on the left show the daylight factor levels obtained on each floor for 2 different variants evaluating the impact of the installed roof windows on the finalized design.

The comparison of results shows the positive effects of adding roof windows on the daylight conditions of the first floor. The roof windows deliver high levels of daylight in the centre part of the main room, as well as in the meeting rooms at the end of the building. The use of roof windows also contributes to raise the daylight levels on the lower floor via a new opening in the existing structural floor situated below the skylights in the hallway.

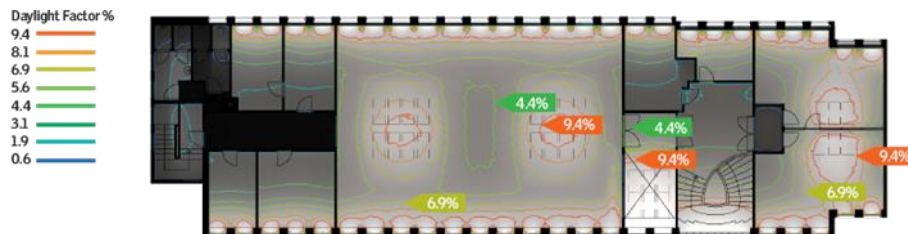

Figure 56: First floor with roof windows.

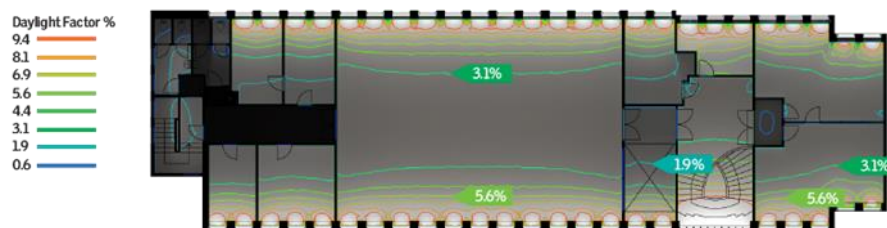

Figure 57: First floor without roof windows.

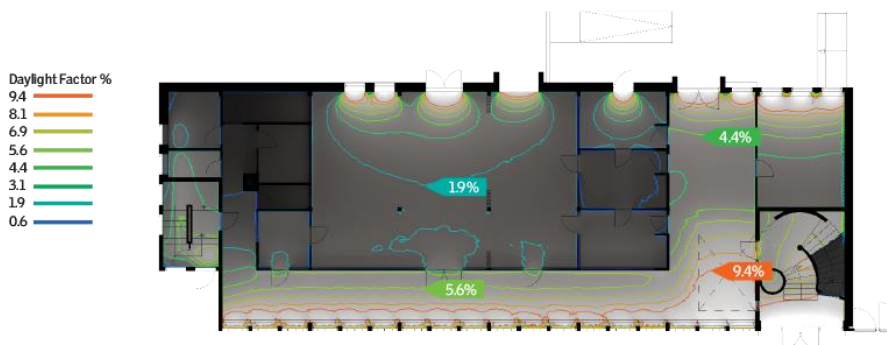

Figure 58: Ground floor with roof windows.

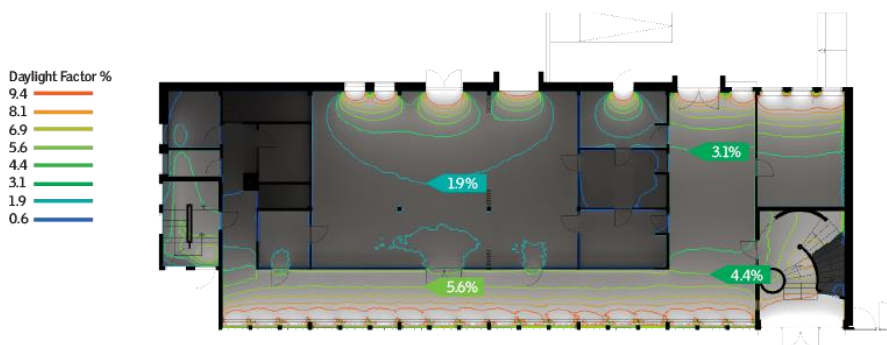

Figure 59: Ground floor without roof windows.



Figure 60: The roof lights provide lots of daylight to the first floor in the building.

The description and pictures given above is taken from:
http://www.velux.com/sustainable_living/demonstration_buildings/osram

9.7 Dynamic analysis of the existing block of Schueco Head Office in Padova, Italy

Giorgio Pansa, Politecnico di Milano
Tiziana Poli, Politecnico di Milano
Laura Begarelli, Politecnico di Milano
Lavinia Tagliabue, Politecnico di Milano

The new Schüco Head Office, located in Via del Progresso n. 42 in Padova, comes from the refurbishment of an industrial building, using an existing prefabricated block, built in the beginning of the 1990 (named "BOAT" and green surrounded in the following figure). During the refurbishment phase, a new building (called the "BUTTERFLY" due to its shape and red surrounded in the figure) has been built. The two buildings are connected through a boardwalk (the yellow block in the figure).

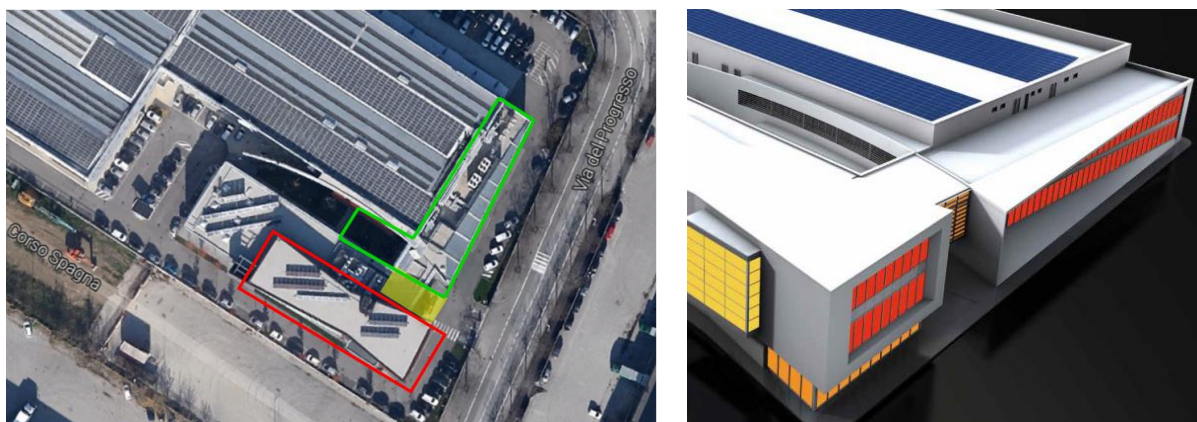

Figure 61: Aerial view of the area (left) and image (right) of the building extracted by the book "Schuco Italia Headquarters: Architecture, Sustainability, Well-being".

The up-to-date building is composed by two zones with different uses: in the north-west zone a unique volume is used as showroom while the south-west zone, composed by three floors, is used as offices and conference hall. The other building, recently refurbished, has a restaurant (south-west zone in the ground floor) and offices. The net heated floor area of the whole building is about 3950 m². In the following table the data of the buildings are resumed.

Table 27: Buildings' surface and volume data.

	Net heated floor area [m ²]	Net heated volume [m ³]	Gross floor area [m ²]	Gross Volume [m ³]
BOAT	1333.29	3600.03	1515.41	5471.20
BUTTERFLY	2616.71	12670.35	2795.88	14394.60
TOTAL	3950.00	16270.38	4311.29	19865.80

The energy model of the building is focused on the refurbished zone (i.e. the BOAT).

The BOAT building has three exposed façades, facing north-east, south-east and south-west. The other surfaces are adjacent to the building zone used as laboratory and warehouse. In these buildings, in a similar way to this typology of buildings, glazed surfaces are usually widely used: during winter periods this can be identified as an advantage (considering the reduction of heating costs and the solar gain provided in cold but sunny days). On the other hand, during summer periods, without an adequate solar radiation control system, the solar heat has to be calculated as a sensible thermal load to remove to maintain an acceptable comfort level. In the Schüco building the windows have been

carefully designed: south-east and south-west façades (in orange in the Figure 61) have been realized with glazed surfaces from the bottom to the top of the façade, equipped with a double glazing high performance windows with external shading system (aluminum micro-blades). This system is described in the section dedicated to energy modeling.

Furthermore in the south-west façade, where some spaces for conferences are located, a double skin façade has been realized (in yellow in Figure 61) and a a-Si¹ PV² plant is installed. The thin film technology allows awarding the windows with an additional energy role, such as renewable energy devices. Anyway this topic has been excluded in the energy modeling because it is a part of the newest BUTTERFLY building.

9.7.1 HVAC systems description

The system is composed by two thermal plants; the first one is located in the ground floor of the BUTTERFLY building and it is intended just for heating and cooling of the showroom space, whereas the second one, located on the rooftop of the BOAT building, is used to supply the needed energy to other spaces and to integrate the first thermal plant when required to produce DHW³.

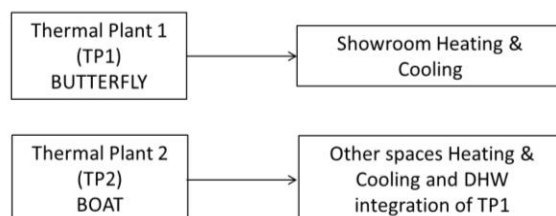

Figure 62: Diagram of the thermal plants used into the building blocks.

The first thermal plant is composed by renewable energy fuelled engines and other devices such as:

- GSHP⁴, supported by a solar system, used to provide heating in winter and DHW for the offices in the new spaces during all the year; the GSHP takes advantage of the ground low temperature (i.e. 12°C) extracted by 7 vertical pipe probes 80 m deep;
- Solar Cooling equipped with absorption chillers to produce cold water in summer period; energy is extracted from a 2000 l water tank which is heated by 18 high temperature (75°C) solar thermal collectors; when the solar collectors are not enough to heat the water a gas boiler is used to integrate the energy need; during winter the solar collectors used for the solar cooling integrate the heating system;
- Inertial water tank, inserted between the GSHP and the radiant floor of the showroom and reception spaces, to face the discontinuous heating needs. It is charged by the hot water produced by the GSHP, during the winter period, whereas during summer period the cold water produced by the solar thermal cooling system circulates in the radiant floor;
- Tank-in-tank (900 l): the upper part is used to produce water for the DHW system, the lower part supports the GSHP during the heating process; in sunny days

¹ Amorphous silicon

² Photovoltaic

³ Domestic Hot Water

⁴ Ground Source Heat Pump

the water temperatures in the lower part of the storage tank are enough to satisfy the needs of the inertial tank and substitute the GSHP; moreover the solar system can partially heat the incoming fluid from the vertical pipe probes, contributing to provide additional energy to the GSHP through the ground regeneration in summer period.

The second thermal plant, producing cold and hot water used by the emission components and the battery of the AHU¹ (except the showroom) is a traditional system and it can be described as follows:

- N. 2 AWHP² (Aermec - mod. NRL1000 X°E°°°02) to produce cold water used by AHU batteries (except the showroom) and the fan coils system;
- Gas boiler (Riello - Mod. RTQ 300 GTA) to produce hot water for two purposes: to heat the spaces (except the showroom) and to integrate the storage system of the thermal plant related to the showroom.

The emission system is described below:

- Radiant floor to heat the showroom and reception spaces;
- Wall-mounted (Rhoos, mod.15, mod. 35 and mod. 45) and ceiling-mounted (Aermec, mod.32, mod.42 and mod. 52) fan coils (FCU) in almost all the building's rooms in the BOAT building and in the BUTTERFLY building; in the following table the FCU data are resumed;
- Radiators to heat the restroom;
- Electric water heater to produce DHW;
- Air heating with direct gas firing to heat the test center and laboratory.

In the following figures a schematic diagram of the thermal plants and the technical drawing of the thermal plant rooms are shown.

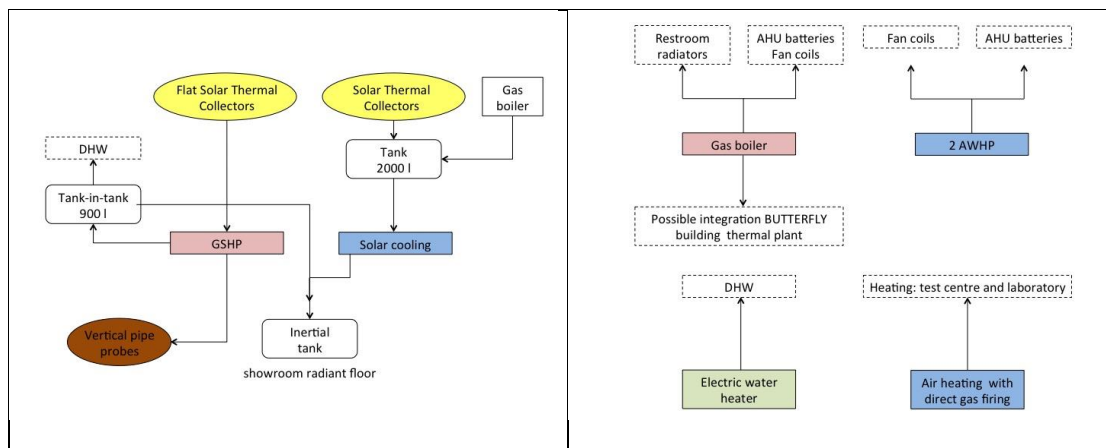

Figure 63: Simplified diagram of the thermal plant in the BUTTERFLY (left) and BOAT (right) building.

¹ Air Handling Unit
² Air to Water Heat Pump

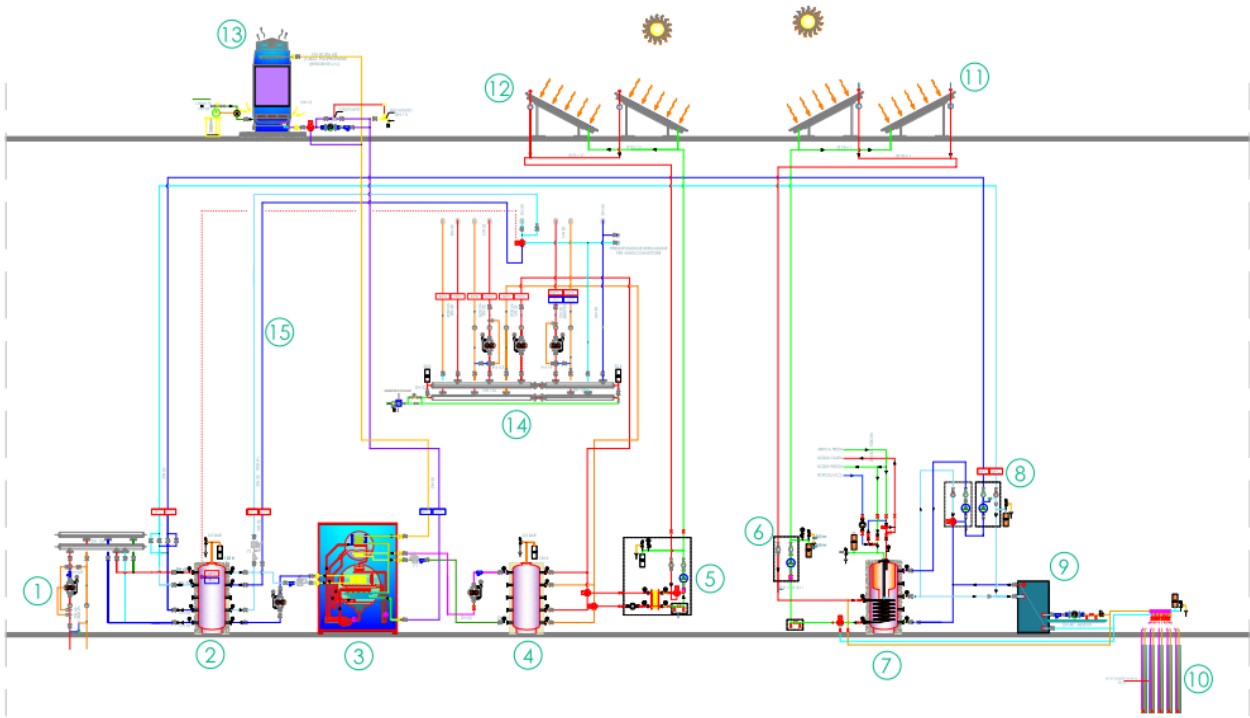

Figure 64: Detailed technical drawings of the thermal plant in the BUTTERFLY building.

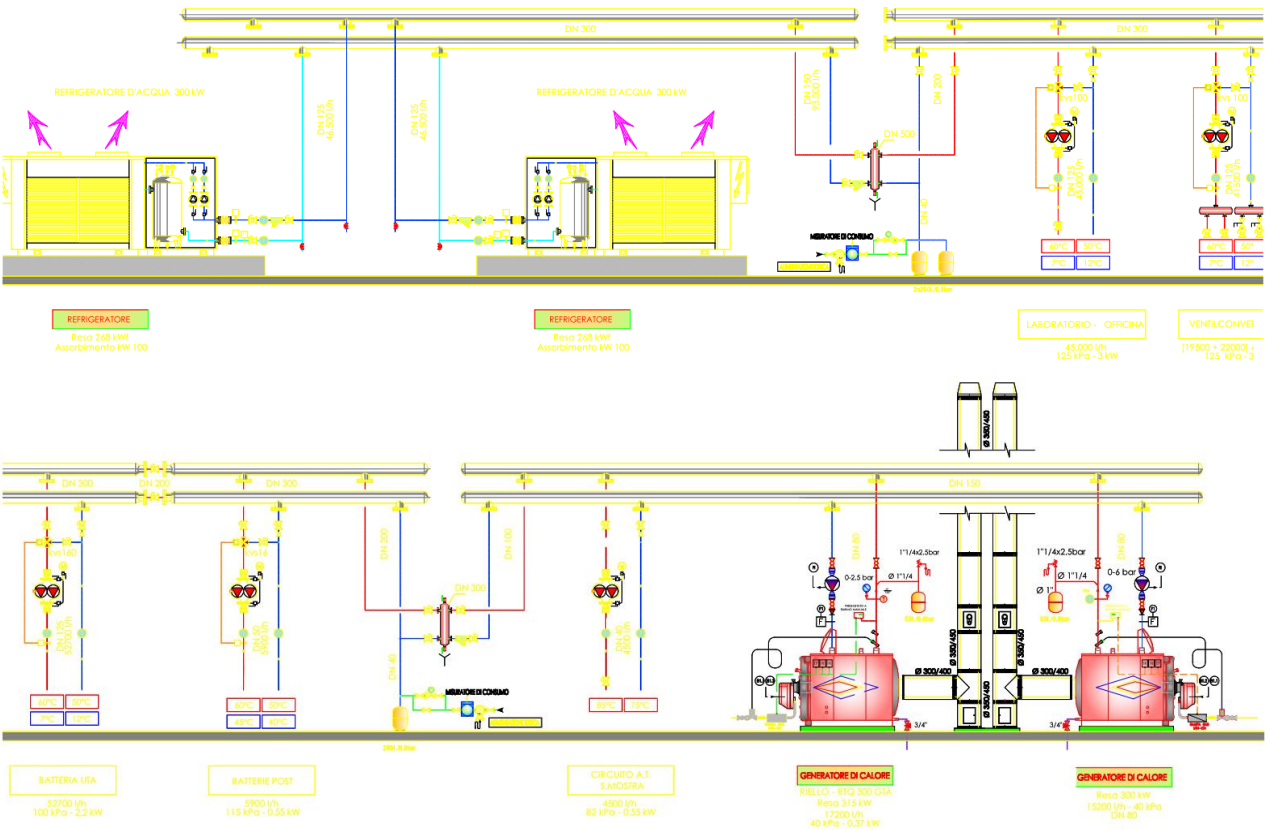

Figure 65: Detailed technical drawings of the thermal plant in the BOAT building

Table 28: Fan coils data (for wall and ceiling installation).

			Wall-mounted FCU			Ceiling-mounted FCU		
			mod. 15	mod. 35	mod. 45	mod. 32	mod. 32	mod. 32
Nominal cooling capacity (tot)	min	kW	0.62	2.00	2.89	1.57	2.31	3.95
	avg	kW	0.87	2.49	3.19	2.06	2.80	4.66
	max	kW	1.02	2.96	4.12	2.21	3.40	4.86
Nominal cooling capacity (sens)	min	kW	0.49	1.46	2.00	1.10	1.64	2.83
	avg	kW	0.70	1.88	2.20	1.54	2.12	3.51
	max	kW	0.80	2.30	3.00	1.75	2.76	3.98
Flow rate	min	l/h	115	343	495	380	585	836
	avg	l/h	161	426	547	380	585	836
	max	l/h	188	507	706	380	585	836
Heating capacity	min	kW	1.35	4.31	6.08	3.38	5.12	8.33
	avg	kW	2.02	5.45	6.58	4.09	6.42	10.94
	max	kW	2.40	6.51	8.88	4.98	7.40	12.92
Flow rate	min	l/h	118	380	535	427	636	1110
	avg	l/h	178	479	579	427	636	1110
	max	l/h	211	573	781	427	636	1110
Air rate	min	mc/h	100	329	431	260	330	520
	avg	mc/h	163	434	474	350	460	720
	max	mc/h	209	547	681	450	600	920
Electrical fans power	min	W	14.00	25.00	38.00	97.00	111.00	97.00
	avg	W	23.00	35.00	41.00	97.00	111.00	97.00
	max	W	32.00	54.00	70.00	97.00	111.00	97.00

Furthermore, n.5 AHU can be found in the system (n.2 AHU for the BOAT building and n. 3 AHU for the BUTTERFLY building). The AHUs are listed below:

- AHU 1: Showroom BUTTERFLY building (Rhoss mod ADV-S 2021 TT6046);
- AHU 2: Offices BUTTERFLY building (Rhoss mod. ADV 1720 TT6046);
- AHU 3: Conference hall BUTTERFLY building (Rhoss mod. ADV 1530 TT6046);
- AHU 4: Offices BOAT building (Rhoss mod. ADV-S 1461 TT6046);
- AHU 5: Canteen BOAT building (Rhoss mod. ADV-S 1071 TT6046).

AHU data are resumed in the following table.

Table 29: AHU data.

		UTA_01	UTA_02	UTA_03	UTA_04	UTA_05	
1	Air return	m ³ /h	7500	6630	6000/2400	4570	3600
2	Double flux heat recovery (efficiency)	%	-	50	50	50	-
3	Battery (+ and -)	l/h	6800	15400	10800	12800	6900
4	Humidifier		-	-	-	-	-
5	Battery (post +)	l/h	2650	1900	-	1600	600
6	Air supply	m ³ /h	7500	6280	6000/2400	5290	3900

In the energy analysis, only the air handling units used by the BOAT building (AHU4 and AHU5) are modeled. A specific circuit is located in the kitchen, located in the canteen zone of the BOAT building. It is composed by two different parts:

- Recovery circuit: composed by a recovery system with a cross flow heat exchanger (Dynair Mod. 1RC1200), flow rate 500 m³/h, with an additional battery (post-heating);
- Extracting exhaust air system (kitchen) (Mod. ADV-S 1461-4025), flow rate 7500 m³/h, with inlet air fan (Rhoss Mod. ADV-S 881-4025), flow rate 4500 m³/h, and a 30 kW heater battery inside the duct.

9.7.2 Climate and energy bills

The new Schuco building is located in Via del Progresso n. 42 in Padova, Italy. The reference climate is Venice (weather file: Venezia-Tessera-161050, source: TM2) that has a similar weather conditions to Padova. In the following diagrams the trend of the average monthly temperature, relative humidity and solar radiation on the south façade (global, beam and diffuse) are plotted.

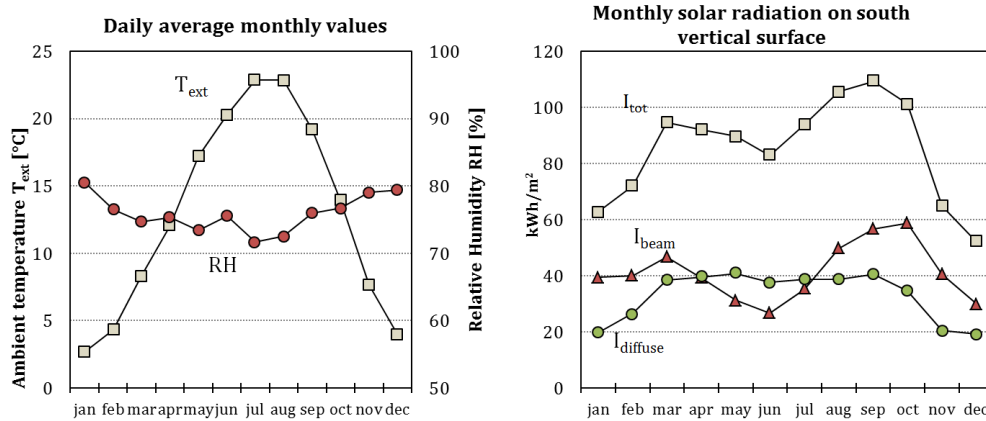

Figure 66: Outdoor air temperature and solar radiation on vertical surface south oriented.

Data about gas consumptions are reported in the following table. With regards to gas consumptions, there is a unique gas meter for all “offices” (4'450 m², including a laboratory and a part of the warehouse to the offices of BOAT and BUTTERFLY building) and the warehouse (14'600 m²). Therefore, there is a problematic split of consumptions between renovated and new building. In addition, no information on the energy consumption of the original building is provided (the original building was different, in term of conditioned volume and HVAC equipment).

HDD, obtained from data of “Orto Botanico” weather station of Padova, ARPAV, are 2523, 2332 and 2400 (for 2010, 2011 and 2012), whereas HDD of the climatic file used for the simulation are equal to 2628.

Table 30: Metered data about natural gas and electricity consumption

Year	Natural gas consumptions (m ³)			Electricity [kWh]			
	Offices	Warehouse	Overall	Bought	Sold (PV system)	Self-consumed (PV system)	Overall consumpt.
2010	53'988	68'937	122'925	755'488	217'266	265'365	1'020'853
2011	38'918	56'506	95'424	641'515	245'909	424'697	1'066'212
2012	29'414	43'418	72'832	-	-	-	-

9.7.3 Building envelope energy model

9.7.3.1 Thermal zones

The BOAT building has been modeled considering two different thermal zones:

- Canteen zone (blue): composed by the following spaces: canteen, kitchen, dressing room, restroom in the ground floor south-west wing;
- Office zone (green): composed by the offices at the first floor south-west wing and offices at the ground floor and first floor south-east wing.



Figure 67: Ground (left) and first floor (right) view of the modeled building.

In the following table, surfaces and volume of the two thermal zones are resumed.

Table 31: Modeled buildings' surface and volume data.

	Net Conditioned Area [m ²]	Net Volume [m ³]	Gross Floor Surface [m ²]	Gross Volume [m ³]
BOAT Offices	1030.02	2713.12	1202.07	4170.82
BOAT Can-teen	303.87	886.91	313.34	1300.36
TOTAL	1333.89	3967.41	1515.41	5471.20

9.7.3.2 Building components

The building components of the two zones can be divided into 4 classes as listed below:

- CV=vertical envelope, dividing the outdoor from the indoor space, 90° tilt angle;
- PV=vertical partition, dividing two indoor spaces, 90° tilt angle;
- CO=horizontal envelope, dividing the outdoor from the indoor space, 0° tilt angle;
- PO= horizontal partition, dividing two indoor spaces, 0° tilt angle.

Table 32: Building components layers (with reference to Figure 68).

1	Gypsum plasterboard	7	Vapour barrier (bituminous paper)	13	Aluminium alloy
2	Expanded polystyrene	8	Unwoven	14	Gravel
3	Reinforced concrete	9	Waterproofing	15	Trespa panels
4	Ceramic tiles	10	Gravel block	16	Mineral wool
5	Concrete floor	11	Acoustic carpet	17	Glass
6	Hollow clay block	12	Parquet		

<p>CV.01 - Vertical envelope Reinforced concrete</p>	<p>CV.02 - Vertical envelope Offices above the canteen</p>	<p>CV.03 - Vertical envelope North facing Offices</p>
		
<p>PV.01 - Vertical partition BOAT wing</p>	<p>PV.02 - Opaque vertical partition</p>	<p>PV.03 - Transparent vertical partition</p>
		
<p>CO.01 - Horizontal envelope Lower ground floor slab</p>	<p>CO.02 - Horizontal envelope Rooftop</p>	<p>PO.01 - Horizontal partition Slab between two heated floors</p>
		
<p>PO.02 - Horizontal partition Slab on open space</p>	<p>PO.03 - Horizontal partition Thermal plant room slab</p>	<p>PO.04 - Horizontal partition Stairs</p>
		

Figure 68: Building components used in the energy model.

In the following figures, main building components in the ground floor and first floor plans are shown. The dashed lines show the windows typologies.

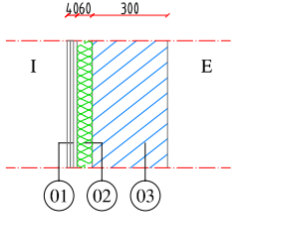
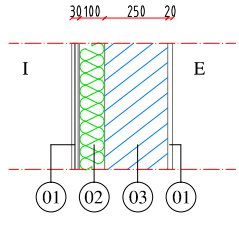
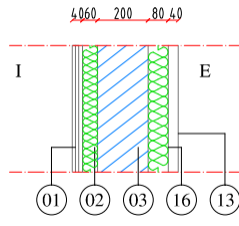
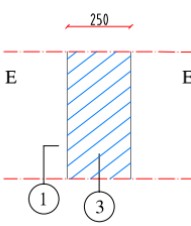
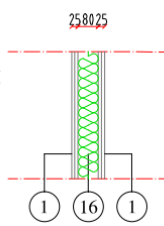
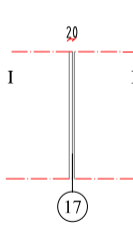
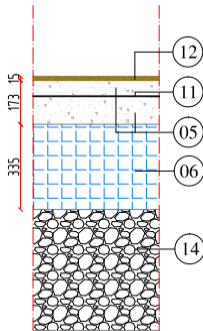
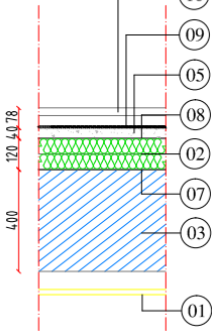
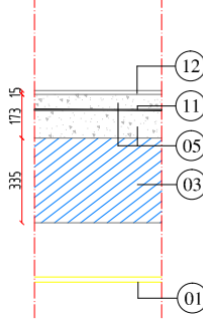
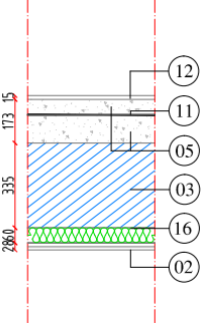
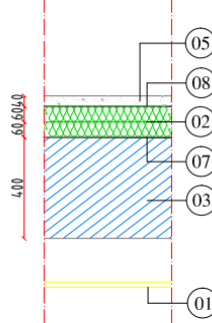
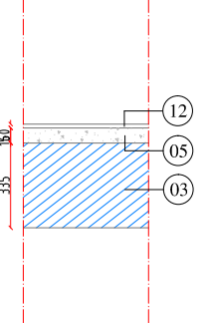
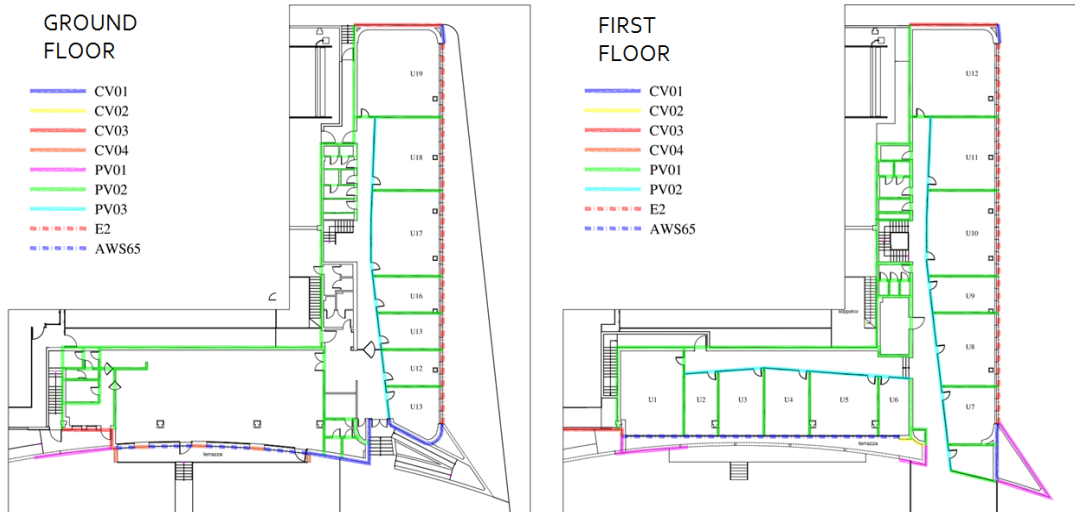
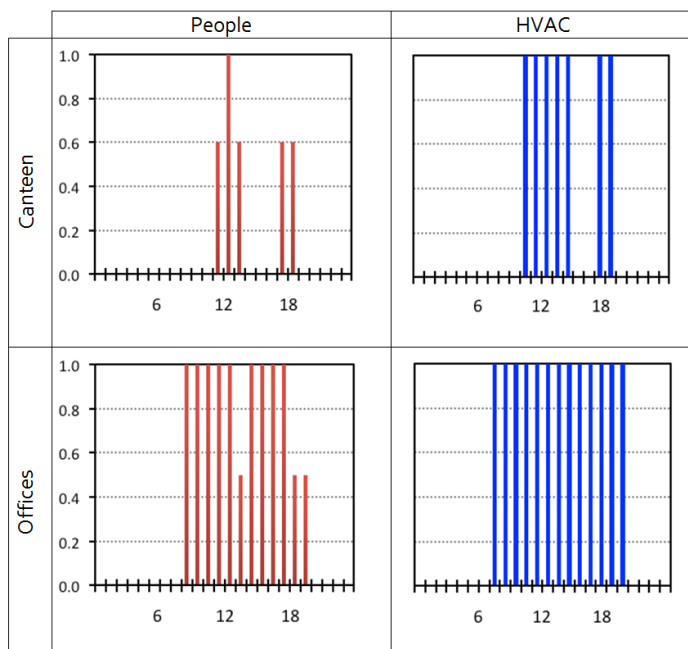

Figure 69: Ground floor and first floor plan view of BOAT building, with building component layers (opaque walls and windows).

9.7.3.3 Schedules and internal gains

For each zone, values for occupation, functioning time for HVAC and lighting system have been defined. Following graphs show the adopted schedules.

On Saturday morning offices are occupied from 8:00 to 12:00. During these days, HVAC are therefore running from 7:00 to 12:00, while lighting is on from 7:00 to 12:00 during the winter and from 7:00 to 11:00 during the summer.



Following assumptions have been made for the lighting system modeling:

- Offices: lights are on from 7 to 20 during the winter; from 7 to 11 and from 17 to 20 during the summer;
- Canteen: lights are on from 10 to 15 and from 17:30 to 19:30 during the winter; from 10 to 15 and from 17:30 to 19:30 during the summer half of the lights are on.

Figure 70: Schedules for the presence of people and HVAC operation.

Each schedule is coupled to a specific internal heat gain. In the office spaces the following value have been assumed:

- Occupancy: 94 people; $Q_{tot}=120$ W/p; $Q_{sens}=65$ W/p; $Q_{lat}= 55$ W/p;
- Lighting: 10 W/m²; 40% convective (fluorescent lighting);
- Equipment: 25 devices; 140 W/each.

In the canteen zone the following value are assumed:

- Occupancy: 50 people; $Q_{tot}=170$ W/p; $Q_{sens}=75$ W/p; $Q_{lat}= 95$ W/p;
- Lighting: 5 W/m²; 40% convective (fluorescent lighting);

The internal gains are complying ISO 7730 standard.

Moreover, additional internal gains have been ascribed to the canteen due to kitchen devices. For these specific equipments, the missing data have been replaced with the ASHRAE values (ASHRAE Handbook Fundamentals - Chapter 16 "Nonresidential cooling and heating load calculations" - tables 5A e 5E).

Table 33: Internal gains assumed in the modeling of the canteen.

Kitchen loads	Radiative		Convective		Radiative		Convective	
	W	kJ/h	W	kJ/h	W	kJ/h	W	kJ/h
Dishwasher	0	0	580	2088	818	2944.8	1398	5032.8
n. 2 micro-wave oven	0	0	0	0	0	0	0	0
Oven	645	2322	3048	10972.8	0	0	3693	13294.8
Cooker	88	316.8	176	633.6	762	2743.2	1026	3693.6
Freezer	147	529.2	176	633.6	0	0	323	1162.8

9.7.3.4 Windows and shadings

The building has two different window typologies:

- The south-east façade is made by Schüco E2 façade;
- The south-west façade is made by AWS65 façade.

The Schüco E2 façade is realized with a high insulated mullion and transom system. The system includes the Schüco CTB solar shading system made by aluminium micro-blades. The U-value of the system is $U_w=1,5$ W/(m²K) considering glass+frame. The system (glass+shading micro-blades) has a solar factor (g-value) of 0.07 maintaining an optimal daylighting level and allowing a visual continuity with the outdoor environment (solar elevation 20° and glass g-value=0.6). The shading control is connected to a weather-monitoring control panel that allows opening and closing the shading devices automatically. The shading devices are activated as a solar radiation threshold value (i.e. 120 W/m² during summer and 200 W/m² during winter) is exceeded. Moreover, in winter period the micro-blades screen is not totally closed but it permits the entrance of the solar radiation for a 70-100 cm strip from the floor level, in order to avoid glare problems. In the following figure the façade is shown.

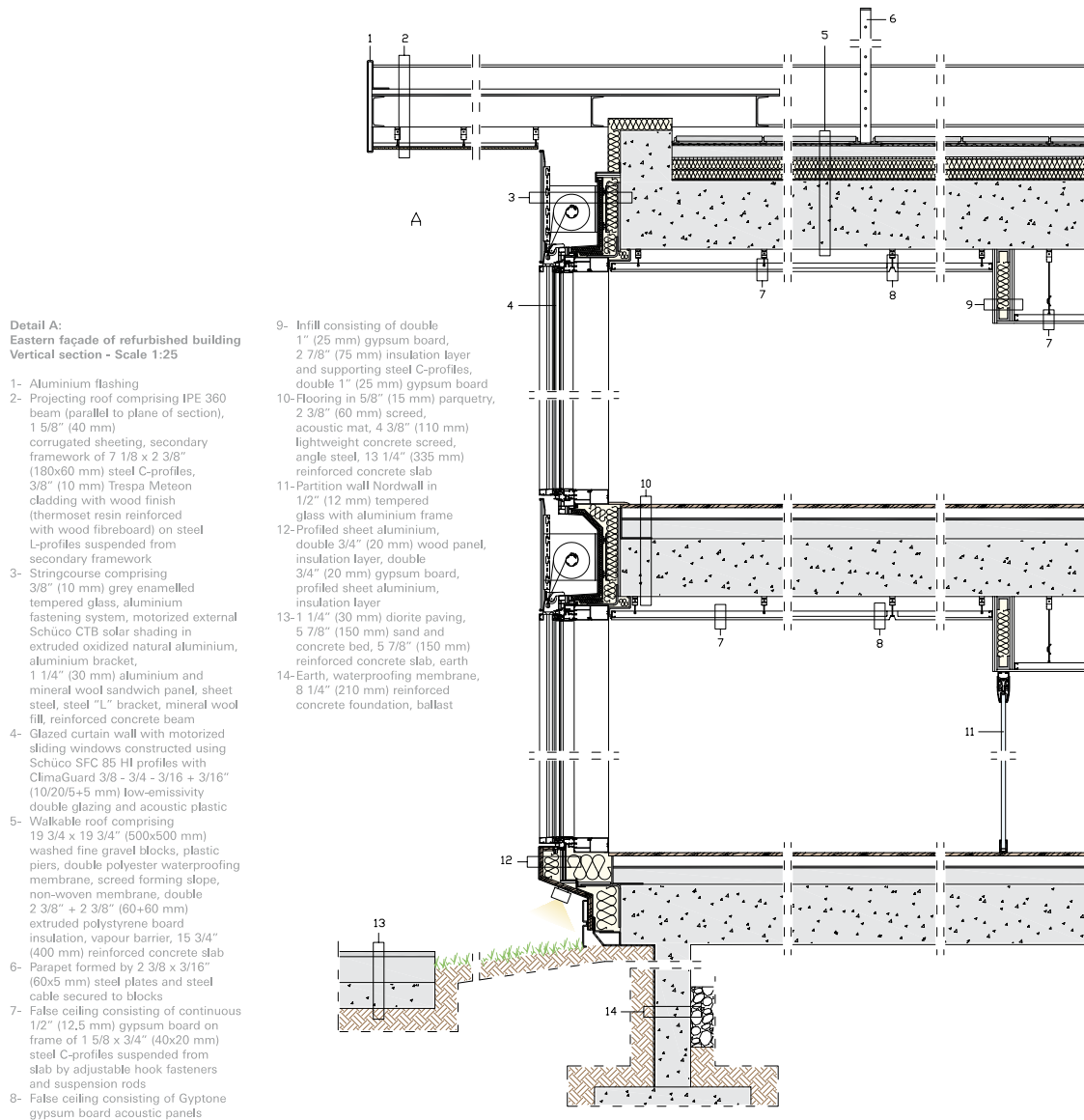

Figure 71: The Schüco E2 façade technical Description.

The AWS65 façade (Aluminum Window System), located on the south-west façade, is made by new generation high insulation windows, low thickness and thin sections. In this specific project the frame is 65 mm thick and the U-value is 2.2 W/(m²K).

The shadowing referred to the roof overhang has been considered (South-east façade) using type 34; the shadow due to the presence of the BUTTERFLY building on the south-west windows of the BOAT building has been modeled using type 68. In presence of both obstructions (other buildings and overhangs) the type 68 and type 34 have been applied, in such order. It has to be noted that the types provide the percentage of shaded solar radiation (where 1 means total shading) and the beam solar radiation control works on the incident radiation (amount of radiation striking the window, including the shadows due to external obstructions).

2° STEP: Radiation obtained from STEP 1 is reduced through type 34 in order to consider overhangs and

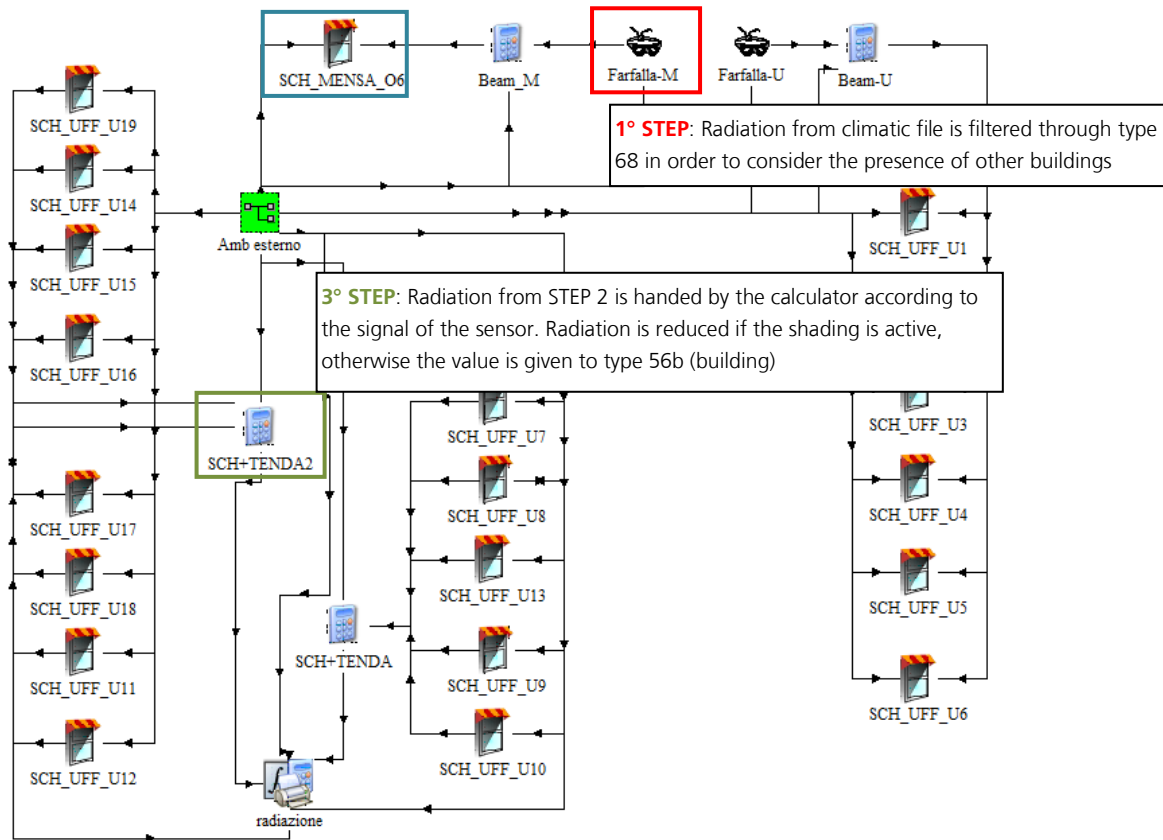

Figure 72: TRNSYS screenshot for shading systems in the model (other buildings, overhangs, fins and shadings).

The activation of the blinds shading system has been included with a more complex procedure. Two modes of operation are modeled:

- **Mode 1:** shading system activation (threshold value 120 W/m^2 in summer and 200 W/m^2 in winter):
- The value to implement in the energy model (TRNBuild) is:
 - $\text{FSS (from type 34)} * 0.12 + g_{\text{blind}}$
 - where
 - g_{blind} is the percentage of solar radiation shaded by the blind (is equal to 0.88);
 - 0.12 is the ratio between the solar factor (FS) of the whole system window+blind (0.06) and the solar factor of the window (0.5); it represents the amount of solar radiation that is not shaded by the window+blind system (and thus that can be shaded by possible overhangs and obstructions);
- Since different sensors are installed to manage the shading system, each window has been modeled separately.
- **Mode 2:** no activation of the shading system:
In this case only the Fraction of solar shading (FSS) provided by type 34 is considered.

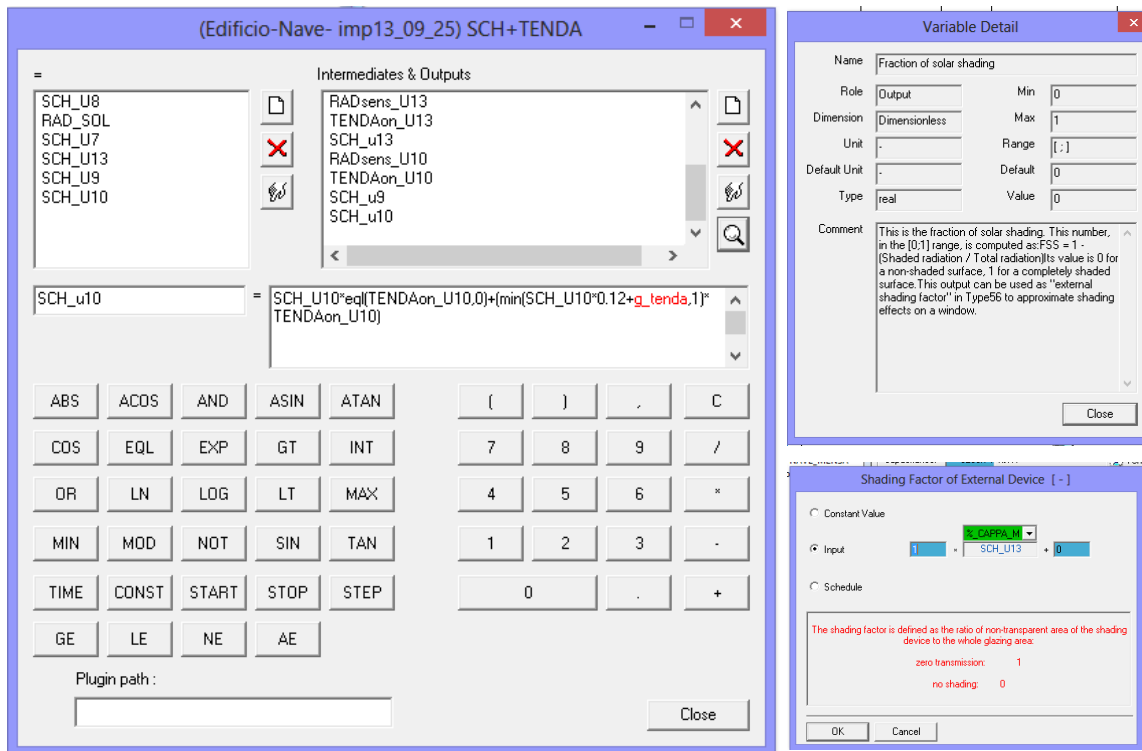

Figure 73: Figure 74: Screenshot (left side) used in TRNSYS to model the blinds activation. On the right side (upward) there is the definition of the output "Fraction of solar shading FSS" in type 34 and (downward) the definition of FSS parameter in type 56b (building).

In TRNBuild there is a glass with g-value=0.5 and with the described procedure it is possible to obtain a composed g-value (considering the whole system window + shading device) equal to 0.06. Furthermore the shadowing effect due to overhangs and external obstructions is included (type 34).

In the Figure 72 the procedure is exemplified. The three step of shading analysis are not always used, depending by the specific situation. When there is no external obstruction the first step is omitted (and step 2 is directly performed). The implementation of this procedure on hourly basis has been carried out through the software TRNSYS software.

The simulation has been performed neglecting the lowering of the blind since 70-100 cm from the floor (in the winter season) and the users' manual control of the blind.

Something crucial has been observed in the simulation, i.e. the inconsistency of the output given by "Fraction of solar shading" of type 34 (see the previous figure). The FSS coefficient is equal to zero when there is no shading and it is equal to 1 for total shading. Checking the previous equation when the whole radiation is blocked (shaded radiation=1), FSS is equal to zero. The accuracy of the 0/1 values is confirmed by type 56 (see previous figure, "Shading Factor of External Device"). It can be inferred that there is an error in the numerator of the equation.

9.7.4 HVAC model

The HVAC system has been dynamically modeled using TRNSYS. The time-step is 15 min to evaluate the thermal behavior and the energy consumptions during a year.

In the following figure, a screenshot of the general framework of TRNSYS is shown. It is possible to recognize the modeled main components: the building (type 56b), the AHU

and the fan coils system in the canteen thermal zone and the offices thermal zone, the ventilation system (extraction and intake air) of the kitchen in the canteen zone, the shading system (type 68 and 34), the automation and control system.

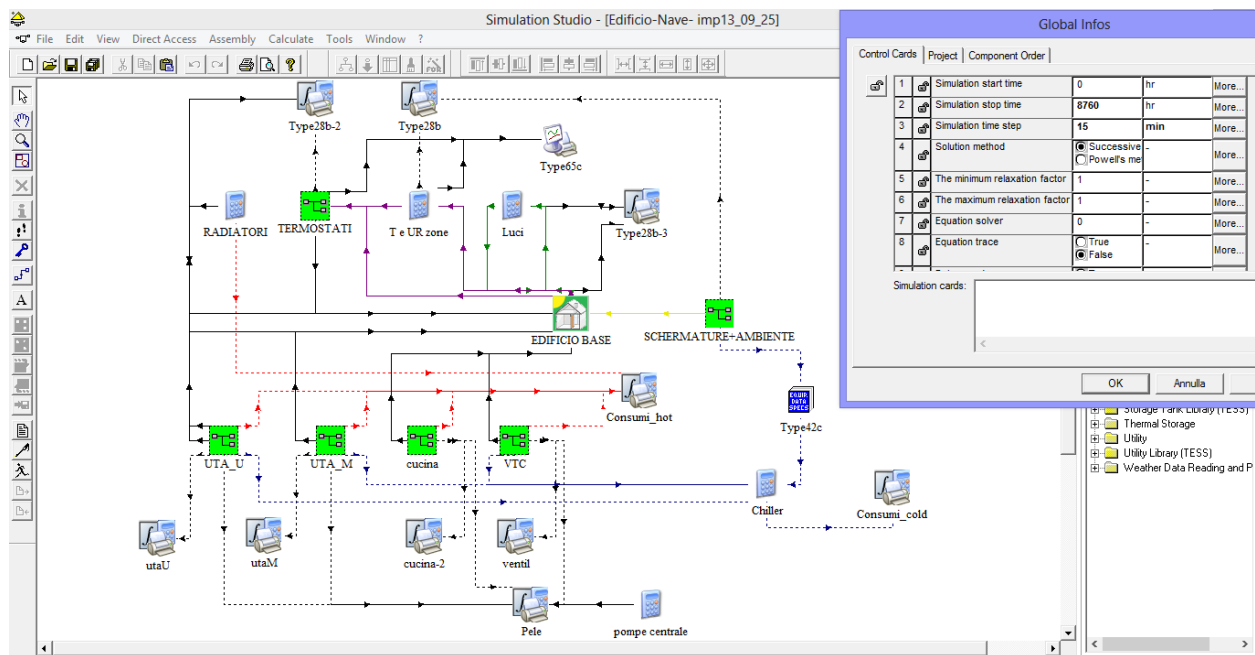

Figure 75: Screenshot of the Building-System model in TRNSYS.

The used types used in the energy modeling are listed in the following table.

Table 34: List of used types.

TYPE	Name	Description
2b	Controllers - Differential Controller w_Hysteresis - for Temperatures - Solver 0 (Successive Substitution) Control Strategy	Used to model the on/off thermostat with dead band
5e	Heat Exchangers - Cross Flow - Both Fluids Un mixed	Fan coils or AHU heater battery
11b	Hydronics - Tempering Valve - Other fluids	Used to model the mixing valve with temperature sensor
22	Controllers - Iterative Feedback Controller	Used to change the water flow rate in the battery related to air temperature overflowing from the same battery
23	Controllers - PID Controller	Used to change the water flow rate in the battery related to air temperature overflowing from the same battery. The difference between type 23 and 22 is that type 23 implements a proportional, integral and derived control
28b	Output - Simulation Summary - Results to External File - Without Energy Balance	Printer with an embedded calculator. The simulation has a time-step of 15 min and the type integrates the results given by the software to provide as output a single hourly value.
32	HVAC - Cooling Coils - Simplified	Fan coils and AHU cold battery
42c	HVAC - Conditioning Equipment - 1 Independent Variable	Used to model the efficiency variation of the chiller as a function of the outdoor air temperature.
33c/e/f	Physical Phenomena - Thermodynamic Properties - Psychrometrics	Used to calculate an unknown thermodynamic parameter from two known parameters.
34	Loads and Structures - Overhang and Wingwall Shading	Used to model overhangs and shading devices.

56b	Loads and Structures - Multi-zone Building - Without standard output files	Allows connecting files of the building model created with TRNBuild.
65c	Output - Online Plotter - Online Plotter With File - No Units	Printer to generate an output file calculated by the software. As opposed to type 28b type, 65c doesn't integrate data but provides a single value for each time-step.
68	Physical Phenomena - Shading Masks - Shading on opening	Used to model any adjacent element to the building modeled and which represent a shading surface (in this project the BUTERFLY building).
69d	Physical Phenomena - Sky temperature - calculate cloudiness factor	Coupled to a weather file and type 33, type 69d allows calculating the sky temperature (Fictive Sky Temperature) used to implement type 56b (building)
91	Heat Exchangers - Constant Effectiveness	Type 91 is the simplest between the types used to model exchangers. In this project, it has been used to model the heat exchangers.
109	Weather Data Reading and Processing - Standard Format - TMY2	Allows reading a weather file (in this project a TMY2 file).

The hypotheses realized to simplify the model have been divided into four groups.

9.7.4.1 Operation and controls

The activation of the HVAC system is different in the two thermal zones as described in the following table.

Table 35: Activation of the HVAC systems in the BOAT building.

	Canteen thermal zone		Offices thermal zone	
Weekdays	10.00 a.m.	3.00 p.m.	7.00 a.m.	8.00 p.m.
	5.30 p.m.	7.30 p.m.		
Saturday	-	.	7.00 a.m.	12.00 a.m.

In both thermal zones, the HVAC system does not work on Sunday. Holydays have been neglected.

The AHU operating schedule is continuous during HVAC systems operation hours. However, the intake air temperature is controlled and varied as a function of outdoor conditions. The control setting is different for the Offices AHU and Canteen AHU as shown in the following figure.

On the other hand, the emission system, which is installed into the thermal zones (i.e. air heating and radiators), works discontinuously and a thermostat, installed into the rooms, controls each emission unit.

The data used in the simulation are similar to data used in HVAC design phase and they have been extracted from technical documentation provided by the owner.

The infiltration rate assumed is equal to 0.05 vol/h. Indeed, in theory, the opaque and transparent envelope surfaces are realized to assure a perfect air tightness. In the actual building this is impossible and minimum infiltration rate is always predictable.

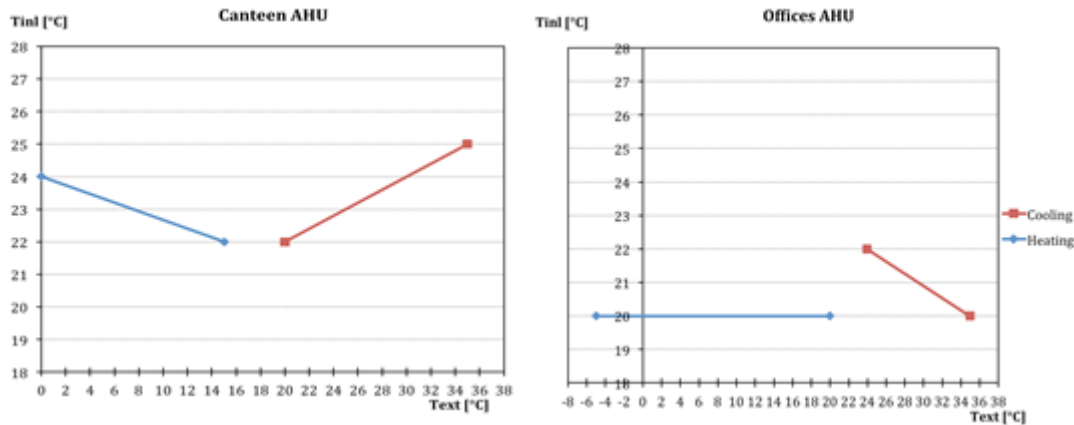

Figure 76: Inlet temperature (Tin) during the cooling and heating season for canteen AHU (left) and office AHU (right).

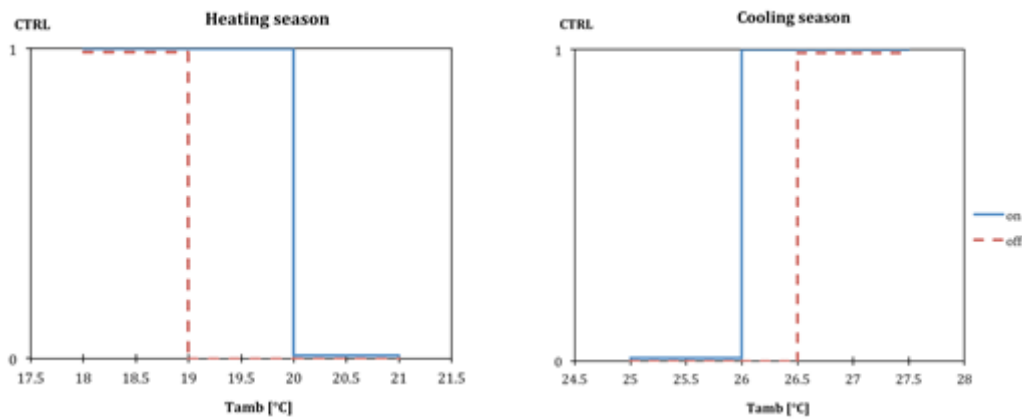

Figure 77: Operation of thermostats in the office and canteen zones during the heating (left) and cooling (right) season.

9.7.4.2 Thermal plants

The modeled thermal plants are the two natural gas boilers (Riello - RTQ300GTA) and two AWHPs/chillers (Aermec - mod. NRL1000 X^oE^oo02). The energy modeling has been consistently simplified for three main reasons:

- The thermal plants are connected to a collector that supports different circuits i.e. the AHU battery circuit, the air heating units, the high temperature water circuit to integrate the system serving the showroom and the circuit of the air heating units of the test center;
- The BUTTERFLY building and the test center are not modeled, thus the collector temperature is hard to predict cause it is depending by the water temperature coming back of all the circuits;
- On the other hand, the use of the collector is to maintain a constant temperature near to the set-point temperature, such as is not a big error to assume 50°C in winter and 19°C in summer.

The previous hypotheses have been used to calculate the natural gas and the electricity consumptions have been calculated dividing the power needed to maintain the hygro-thermal comfort conditions times the efficiency of the specific thermal plant.

Gas boilers efficiency has been assumed as a constant value equal to 0.958, meanwhile for the AWHP chillers the efficiency has been calculated as a function of outdoor air temperature.

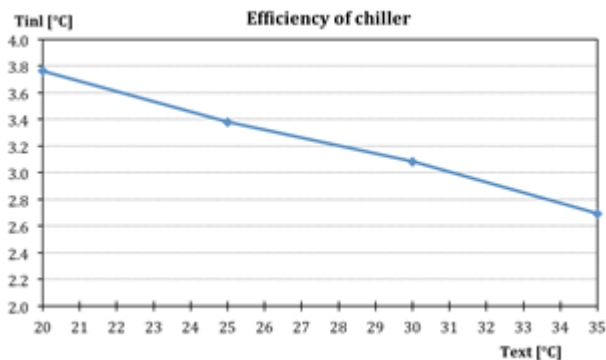

Figure 78: Chiller efficiency referred to outdoor air temperature.

The efficiency values are presumed by the datasheets downloaded by the producer's website.

9.7.4.3 Air Handling Units

THE AHUs operation schedule is continuous when the building is occupied to guarantee the standard airflow rates.

In winter period, a single heater battery is used (water temperature = 45°C) and no humidification is carried out. In summer period, both batteries work: cold water circulates in the first one (water temperature = 15°C) while hot water circulates in the second one (water temperature = 50°C). However, in the main thermal plant hot water is produced with a different temperature equal to 60°C in winter and 14°C in summer. The intake water temperature varies through a three-way valve.

The inlet temperatures vary related to the season and they are regulated as a function of outdoor air temperature as shown in the previous diagrams. A three-way valve controls this parameter too.

As a conclusion, if the inlet air temperature is equal or higher/lower (in the different seasons) than the set-point temperature, the air is not processed and it is directly introduced into the indoor spaces.

The contemporary management of the whole parameters could be performed using the dynamic simulation software.

9.7.4.4 Emission units

In the modeled building there are two different emission units: fan coils (walls and ceiling-mounted) and radiators.

The fan coils can be modeled as batteries in which flows hot water (45°C) or cold water (14°C), with reference to different seasons. A thermostat controls the emission units as described above. Fan coils have been modeled with an average speed except for mod. 45 (offices, maximum speed) and mod. 32 (canteen, maximum speed). These variations have been implemented to guarantee a correct calculation through the software.

To model each fan coils in TRNSYS software, two types have been used:

- type 32 for the fan coils working in summer period, because it includes as output the latent power of the battery (in addition to the sensible power); together with type 32, type 33 have been used to calculate the absolute humidity in addition to dry bulb temperature and wet bulb temperature of the treated air (given by type 32);
- type 5e for the fan coils working in winter period. Since the heater temperature doesn't modify the treated air humidity it is possible to use this specific type that is simpler to use.

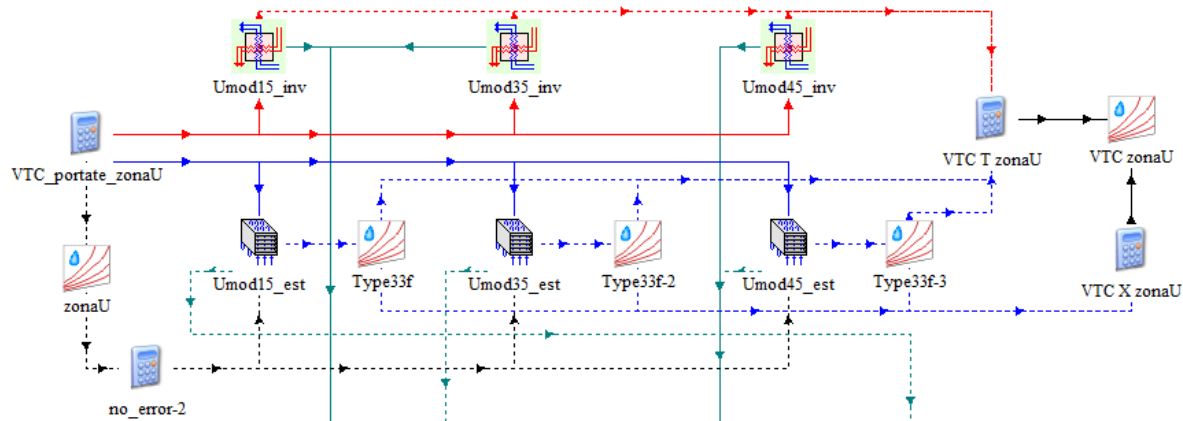

Figure 79: TRNSYS screenshot for office fan coils modeled.

Radiators have been modeled as internal gains activated just in the winter period and controlled by the same thermostat of the fan coils. The following data have been assumed in lack of specific information, based on the main products available on the market:

- n. 5 columns \approx thickness 189 mm, n. 11 elements;
- height = 1000 mm;
- nominal power = 155.4 W;
- adjusted power ($\Delta T=20$): 46.0 W;
- water flow rate 40 l/h to obtain a $\Delta T=10^\circ\text{C}$ (between inlet and outlet water).

In the canteen thermal zone there are:

- n. 2 fan coils wall installed Rhoss mod.35;
- n. 1 fan coil wall installed Rhoss mod.45;
- n. 1 fan coil ceiling installed Aermec mod.32;

and in the offices thermal zone:

- n. 1 fan coil wall installed Rhoss mod.15;
- n. 3 fan coils wall installed Rhoss mod.35;
- n. 36 fan coils wall installed Rhoss mod.45;
- n. 7 radiators.

9.7.4.5 Domestic Hot Water

N. 7 electrical water heaters located in the restrooms produce the DHW. The total electricity consumption is given by the sum of the energy used to maintain the temperature plus the energy due to heat the used water.

The first amount of energy has been calculated considering the following data:

- a daily consumption of 0.6 kWh/day;
- a constant DHW production during 365 day for year.

The energy consumption to maintain the 7 electrical water boilers in the design temperature is equal to 1533 kWh/year. A domestic hot water consumption profile has been used (on the basis of ASHRAE standard conditions).

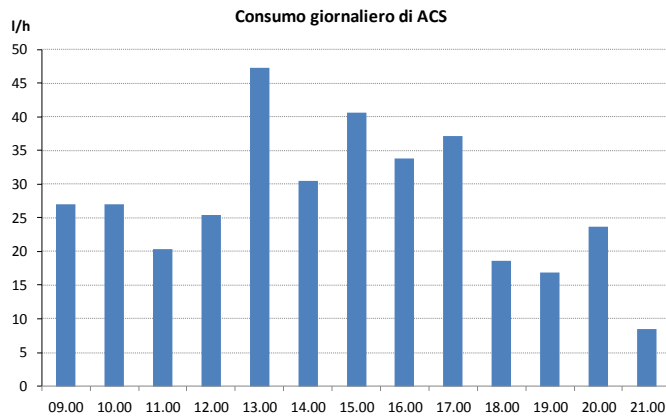

Figure 80: Daily hourly consumption [l/h] of Domestic Hot Water.

Furthermore, the following assumptions have been considered:

- a daily total consumption of 357.01 l/h day;
- the days of use are 261 (as the occupancy days);
- the municipal water system temperature is assumed to be equal to 15°C;
- the water supply temperature required is 45°C.

The total amount of energy consumption due to DHW production is equal to 3254 kWh/year. The final value has been calculated and it is equal to 4787 kWh/year of electricity consumed.

9.7.5 Results

9.7.5.1 Environmental internal conditions for the thermal zones

In the following diagram monthly average data of air temperature and absolute humidity of the air are represented, with reference to the different thermal zones. In each diagram are plotted the outdoor parameters and two different lines: the first one (blue line) considers all the hourly data whereas the second (green line) includes just the hours where the HVAC system is activated.

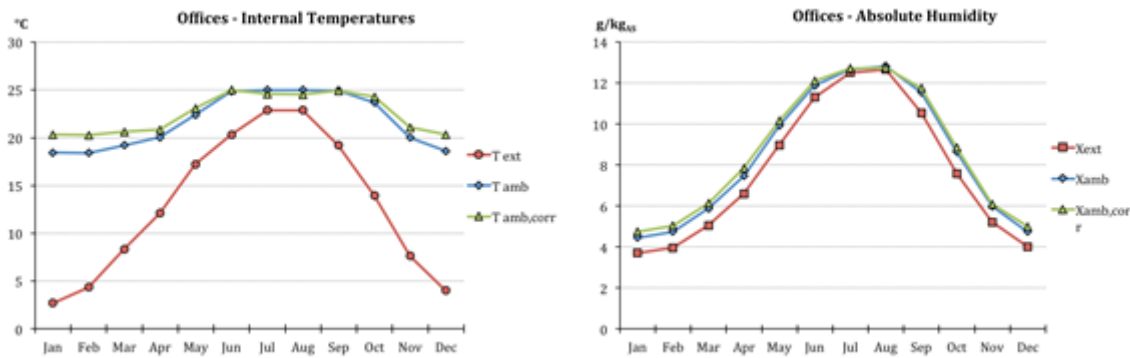

Figure 81: Temperature and absolute humidity values for office zone (monthly average values)

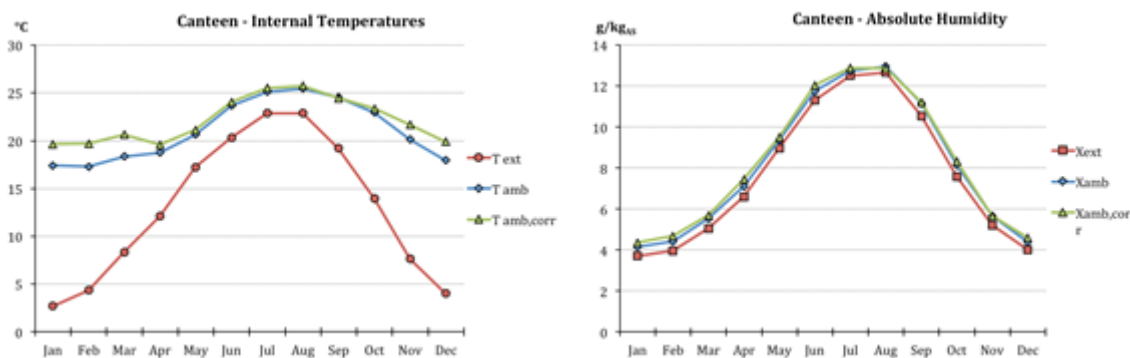

Figure 82: Temperature and absolute humidity values for canteen zone (monthly average values).

9.7.5.2 System behavior under critical conditions

The previous data show that indoor conditions are kept in the comfort range by the HVAC system operation. The next step is to analyze the specific HVAC system behavior in the critical days: the coldest day (12nd January) and the warmest day (17th August).

The following diagrams are represented below:

- The run of the daily indoor air temperature (T_{amb}) in comparison with the daily outdoor air temperature (T_{ext}), in the warmest and coldest day;
- The run of the indoor air temperature (T_{amb}) and the inlet air temperature (T_{fan} and T_{AHU}) during the activation hours of the HVAC (from 7.00 a.m. to 9.00 p.m.) in comparison with the outdoor air temperature (T_{ext}), in the warmest and coldest day;
- The run of the absolute indoor humidity (X_{amb}) in comparison with the absolute outdoor humidity (X_{ext}), in the warmest day.

The absolute humidity in the coldest day is not plotted because the HVAC system is not designed to perform a hygro-thermal control in winter period.

During the coldest day the indoor temperature is about 20°C during the operating hours of the HVAC system and decreases when the HVAC system is turned off. Another important issue to be noted is that fan coils are running only during the morning and evening hours. This means that the AHU is enough to provide the heating to the spaces.

During the warmest day it is possible to perceive that the HVAC system can satisfy the cooling and dehumidification needs, maintaining the interior conditions in the comfort

zone. In this case, the AHU cannot manage independently the cooling load of the indoor space and, as a consequence, the fan coils have to be turned on during the whole period of running.

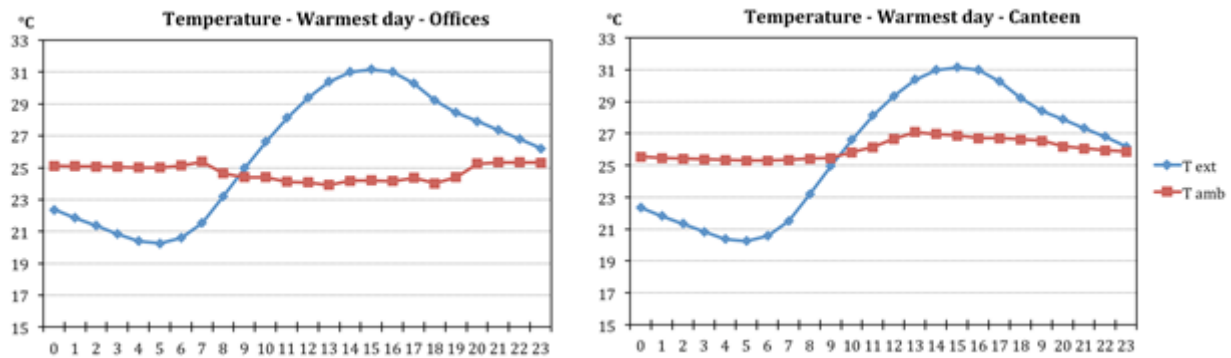

Figure 83: Hourly average temperatures (external and internal) in the warmest day, for the offices zone (left) and for the canteen (right).

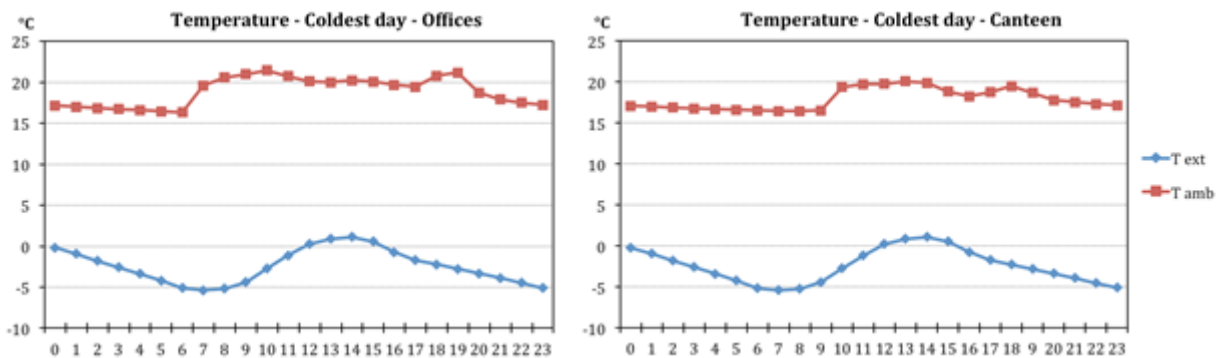

Figure 84: Hourly average temperatures (external and internal) in the coldest day, for the offices zone (left) and for the canteen (right).

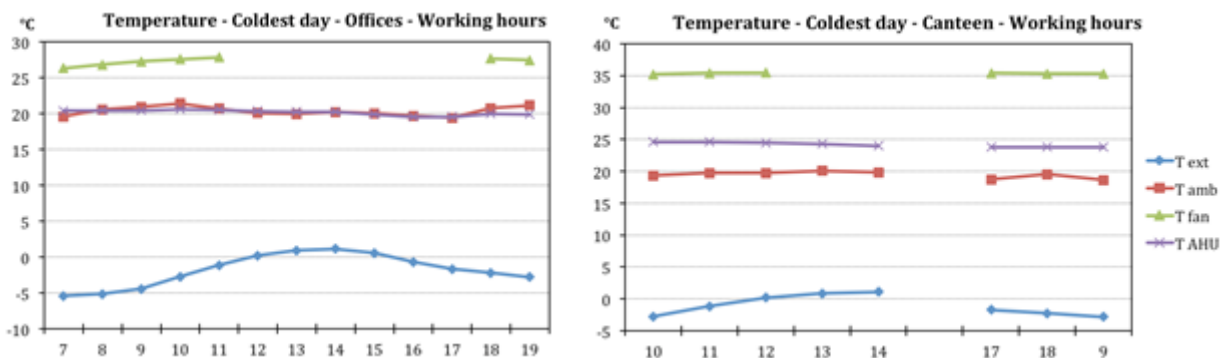

Figure 85: Hourly average temperatures (external, internal, inlet temperature from AHU and fan coils) in the coldest day, for the office (left) and for the canteen (right) zone, during the HVAC operating hours.

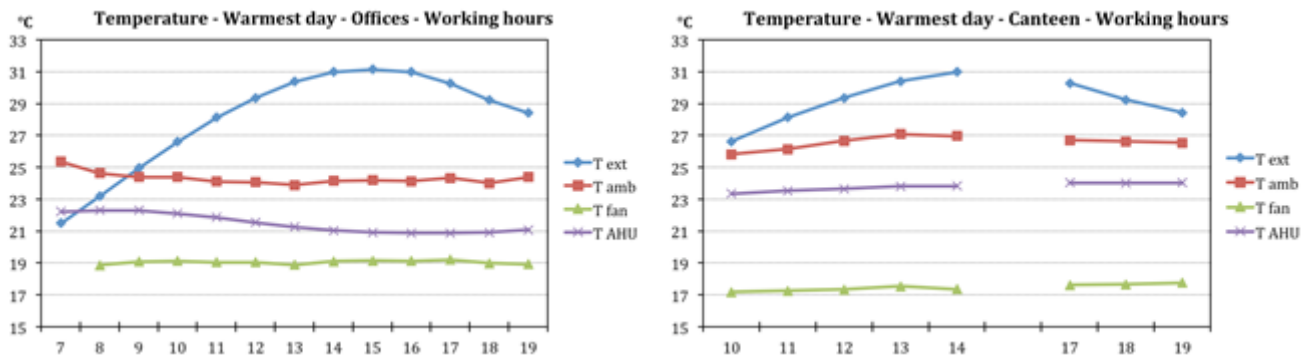

Figure 86: Hourly average temperatures (external, internal, inlet temperature from AHU and fan coils) in the warmest day, for the office (left) and for the canteen (right) zone, during the HVAC operating hours.

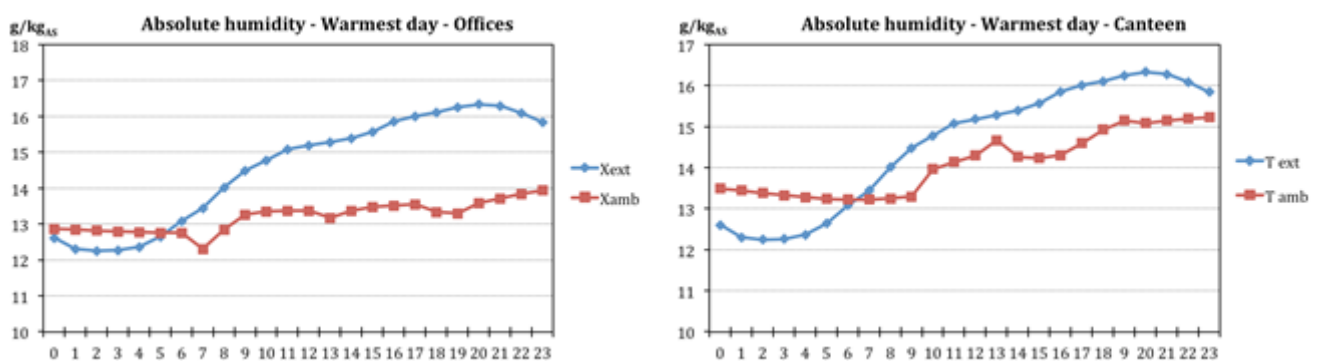

Figure 87: Hourly average values of absolute humidity in the offices zone (left) and in the canteen (right), in the warmest day, compared with external ones.

9.7.5.3 AHU and Fan coils operation

During the whole year the offices' AHU works for 313 days (excluding the national holidays). The daily operation schedule for the AHU goes from 7.00 a.m. to 8.00 p.m. The running hours for the offices' AHU are therefore 3653 hours (42% of the whole period).

The canteen's AHU works during a shorter period in comparison with the previous one (10.00 a.m. to 3.00 p.m. and from 5.30 p.m to 7.30 p.m). The operation period amounts to 1566 hours (18% of the whole period).

Fan coils units (both in the canteen and in the offices) are controlled by thermostats and as a result, they are turned on just in case.

The time trend of the turn on and turn off of the AHU and fan coils are shown in the following diagrams:

- The running hours of the AHU and the batteries during the winter and summer season, both for the canteen and the offices; the two values could not coincide when the outdoor temperature has the correct characteristics to be used as inlet air without treatment;
- The running hours of the fan coils during the winter and summer season, both for the canteen and the offices.

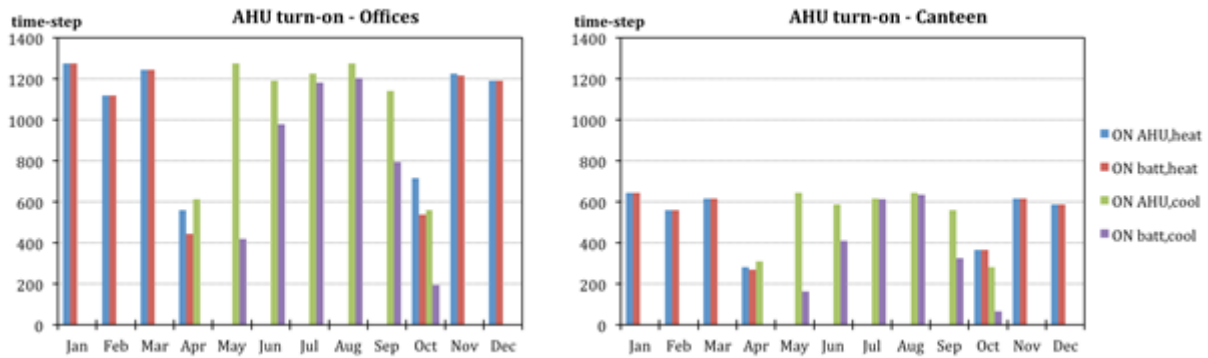

Figure 88: Operating hours for AHU and battery, during the cooling and heating season, for offices (left) and canteen (right).

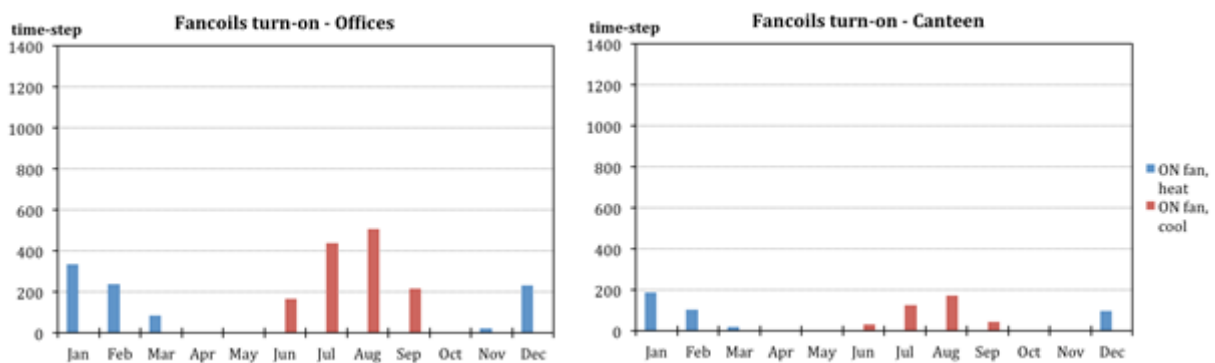

Figure 89: Operating hours for office (left) and canteen (right) fan coils over the whole year.

In the diagrams some interesting topics can be underlined, confirming the general data shown in the incipit of the section:

- In the offices zone, the AHU and fan coils are more activated (compared to the canteen zone);
- The AHU's batteries are not running during a number of hours in the middle periods (i.e. spring and autumn) and during the summer season;
- The fan coils work not so much and only in the months when the outdoor conditions are extreme.

9.7.5.4 Radiation and shadowings

The benefits coming from the shading systems applied to the windows in the offices space are evaluated through the comparison with the building model without shading systems. Figure 96 shows results in term of solar gains.

Generally, the shading system allows a solar gains reduction of about 40%. Solar gains of the refurbished building are lower than solar gains of the baseline building, characterized by a lower transparent area. This means a benefit in the summer season, where energy consumptions due to cold-water production, hot water production for the post-heating and the electricity for fans operation are reduced, while the amount of energy consumption during the heating period increases.

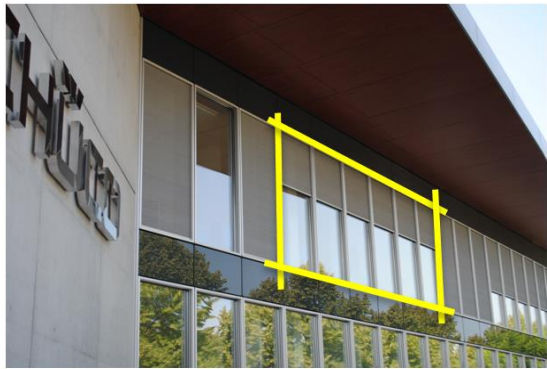
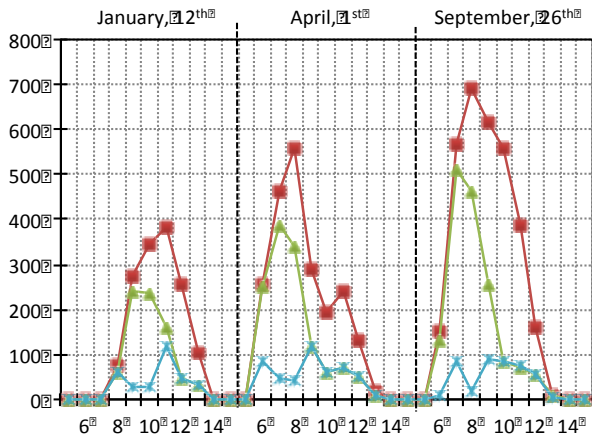

Figure 90: Incident radiation without any obstruction (red), considering the overhangs and fins (green) and with the activation of the sunblind (blue) in the coldest day (Jan, 12th), warmest day (Apr, 1st) and sunniest day (Sep, 26th) for most shaded windows.

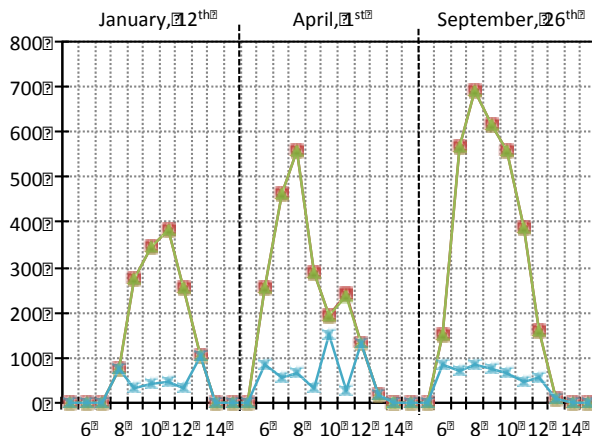

Figure 91: Incident radiation without any obstruction (red), considering the overhangs and fins (green) and with the activation of the sunblind (blue) in the coldest day (Jan, 12th), warmest day (Apr, 1st) and sunniest day (Sep, 26th) for the sunniest windows.

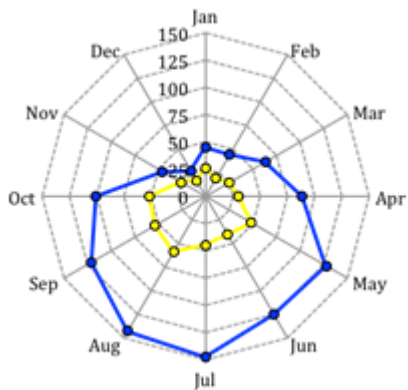

Figure 92: Number of hours where sunblind system is activated, during the whole year, for the sunniest (blue line) and the most shaded (yellow line) group of windows.

9.7.5.5 Energy consumptions

Energy consumption are resumed in the following table as disaggregated values for hot water, cold water, DHW, electricity due to AHU and fan coils pumps and fans operation.

Table 36: Modeled energy consumptions for the BOAT building.

Consumptions	kWh/year	kWh/m ³ year	kW _{EPR} /year	kW _{EPR} /m ³ year
Hot water				
Fan coils, Offices	13'638	2.49	13'638	2.49
Fan coils, Canteen	1'138	0.21	1'138	0.21
AHU-offices, heating	20'956	3.83	20'956	3.83
AHU-offices, post-heating	10'541	1.93	10'541	1.93
AHU-canteen, heating	12'778	2.34	12'778	2.34
AHU-canteen, post-heating	3'594	0.66	3'594	0.66
Radiators	773	0.14	773	0.14
Kitchen	15'911	2.91	15'911	2.91
Dressing room	2'646	0.48	2'646	0.48
	81'975	14.98	81'975	14.98
Cold water				
Fan coils, Offices	4'456	0.81	9'687	1.77
Fan coils, Canteen	272	0.05	590	0.11
AHU-offices, cooling & dehum	5'358	0.98	11'647	2.13
AHU-canteens, cooling & dehum	1'817	0.33	3'950	0.72
Domestic Hot Water				
DHW	4'787	0.87	10'406	1.90
Electrical consumptions				
Fans AHU-offices	17'315	3.16	37'642	6.88
Fans AHU-canteen	4'202	0.77	9'135	1.67
Fans, Fan coils-office	797	0.15	1'733	0.32
Fans, Fan coils-canteen	36	0.01	78	0.01
Fans, kitchen	4'129	0.75	8'976	1.64
Fans, dressing room	537	0.10	1'168	0.21
Pumps, fan coils	2'030	0.37	4'412	0.81
Pumps, AHU	8'037	1.47	17'471	3.19
Pumps, AHU post-heating	1'001	0.18	2'176	0.40
	54'773	10.01	119'072	21.76

9.7.6 Comparison with the existing building (before the refurbishment)

A base case (Baseline) of the building before the energy retrofit has been created, considering the same use of the building (i.e. office spaces). Main features are resumed in the following table. It has to be pointed out that the heated volume and floor area are lower than the refurbished building (since the offices above the canteen were added during the renovation of the building).

Table 37: Characteristics of the Baseline building before the energy refurbishment.

	Net heated floor area [m ²]	Net heated volume [m ³]	Gross floor area [m ²]	Gross Volume [m ³]
Baseline	818.4	2121.1	924	3210.9



The information about the envelope and the HVAC system before the refurbishment are missing of details, thus, many specific parameters have been assumed as hypotheses using as a reference other similar and coeval buildings.

The original building components are shown in the following figure, while the key of the building component layers is the same of Table 32.

Vertical envelope reinforced concrete	Opaque vertical partition	Transparent vertical partition
		
CV.01_old	PV.02_old	PV.03_old
Horizontal envelope Lower ground floor slab	Horizontal envelope Rooftop	Horizontal partition Slab between two heated floors
		
CO.01_old	CO.02_old	PO.01_old

Figure 93: Building components used in the energy model of the Baseline building.

The most significant variation between the Baseline building and the actual building are listed below:

- A thinner layer of thermal insulation in the Baseline (CV.01_old);
- A building component for the rooftop of the Baseline building without insulation layer (CO.02_old).

The windows in the Baseline have a thermal transmittance value equal to $U_w=3.2$ W/(m²K) and a g-value equal to 0.7, without any shading system.

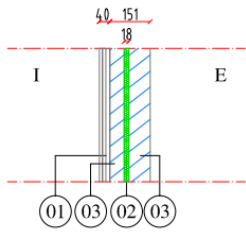
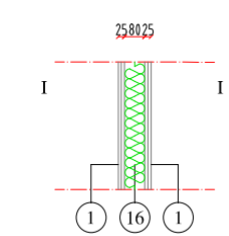
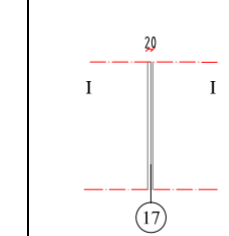
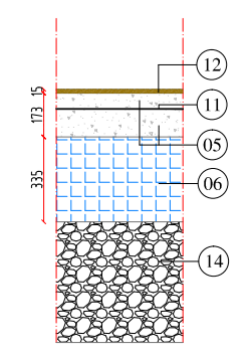
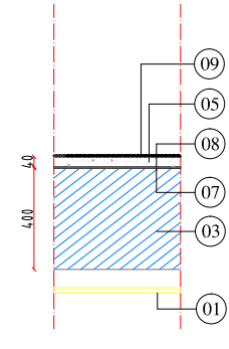
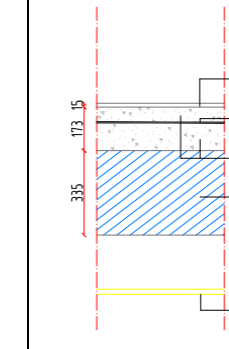
The HVAC of the building operates just in winter period and it is composed by the following elements:

- Gas boiler: efficiency = 0.8;
- Fan coils (same as the actual building) for heating purpose in the indoor spaces and controlled by thermostats;
- Radiators (same as the actual building) for the heating of the restrooms;
- Electric boilers for DHW production.

Following energy consumptions have been calculated.

Table 38: Modeled energy consumptions for the baseline building.

Consumptions	kWh/year	kWh/m ³ year	kW _{EPR} /year	kW _{EPR} /m ³ year
Hot water				
Fan coils, Offices	76'601	23.86	76'601	23.86
Fan coils, Canteen	0	0.00	0	0.00
AHU-offices, heating	0	0.00	0	0.00
AHU-offices, post-heating	0	0.00	0	0.00
AHU-canteen, heating	0	0.00	0	0.00
AHU-canteen, post-heating	0	0.00	0	0.00
Radiators	2'794	0.87	2'794	0.87
Kitchen	0	0.00	0	0.00
Dressing room	0	0.00	0	0.00
	79'396	24.73	79'396	24.73
Cold water				
Fan coils, Offices	0	0.00	0	0.00
Fan coils, Canteen	0	0.00	0	0.00
AHU-offices, cooling & dehum	0	0.00	0	0.00
AHU-canteens, cooling & dehum	0	0.00	0	0.00
Domestic Hot Water				
DHW	3'956	1.23	8'600	2.68
Electrical consumptions				
Fans AHU-offices	0	0.00	0	0.00
Fans AHU-canteen	0	0.00	0	0.00
Fans, Fan coils-office	763	0.24	1'658	0.52
Fans, Fan coils-canteen	0	0.00	0	0.00
Fans, kitchen	0	0.00	0	0.00
Fans, dressing room	0	0.00	0	0.00
Pumps, fan coils	2'058	0.64	4'474	1.39
Pumps, AHU	0	0.00	0	0.00
Pumps, AHU post-heating	0	0.00	0	0.00
	6'777	2.11	14'732	4.59

9.7.6.1 Comfort and solar gains

The evaluation of the existing HVAC system has been performed and the following diagrams are reported to point out if the system could guarantee comfort levels in the indoor spaces:

- The run of the hourly average indoor air temperature (T_{base}) during the coldest (12nd January) and the warmest day (17th August), in comparison with the outdoor air temperature (T_{ext}) and the indoor air temperature calculated for the refurbished actual building (T_{actual});
- The run of the absolute indoor humidity (X_{base}) in the warmest day, in comparison with the absolute outdoor humidity (X_{ext}) and the absolute humidity calculated for the refurbished actual building (X_{actual}).

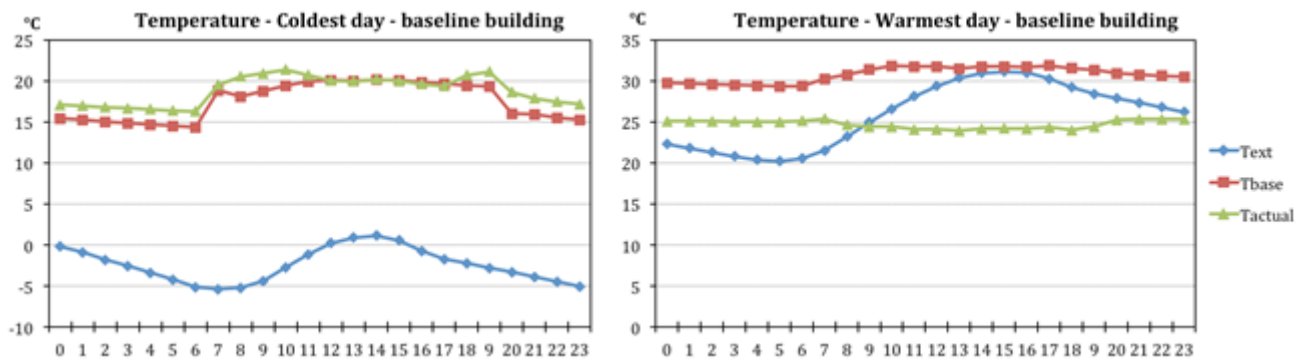

Figure 94: Hourly average temperatures in the coldest (left) and warmest (right) day, compared with the external temperature and result of actual building.

During the heating season the indoor temperature is kept on the target value (20 °C) thanks to fan coils. In summer period, as the Baseline building has no cooling system, the indoor temperatures reach up to 30°C. As a consequence, comfort conditions are not accomplished.

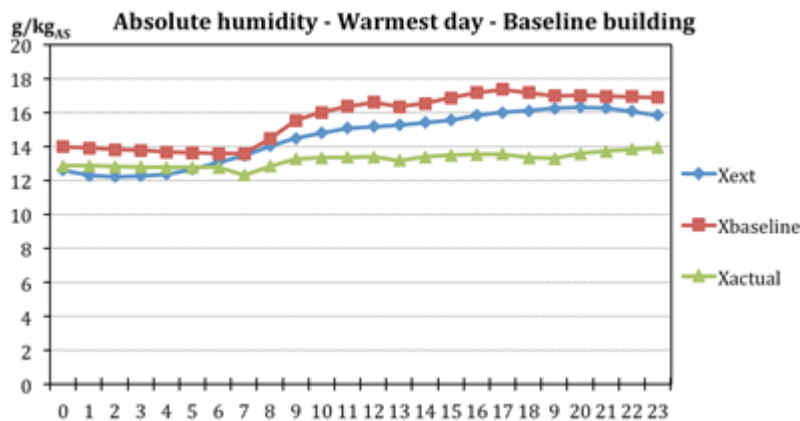

Figure 95: Hourly average values of absolute humidity in the warmest day, compared with the external values and result of actual building.

The humidity values in the Baseline building exceed the acceptable levels, as the building is not equipped with a cooling and de-humidifier system; the humidity values are even higher than the external condition due to internal gains that exacerbate the indoor condition. Lastly, the diagram of the solar gains of the Baseline building is compared with the values of the actual building, as shown below.

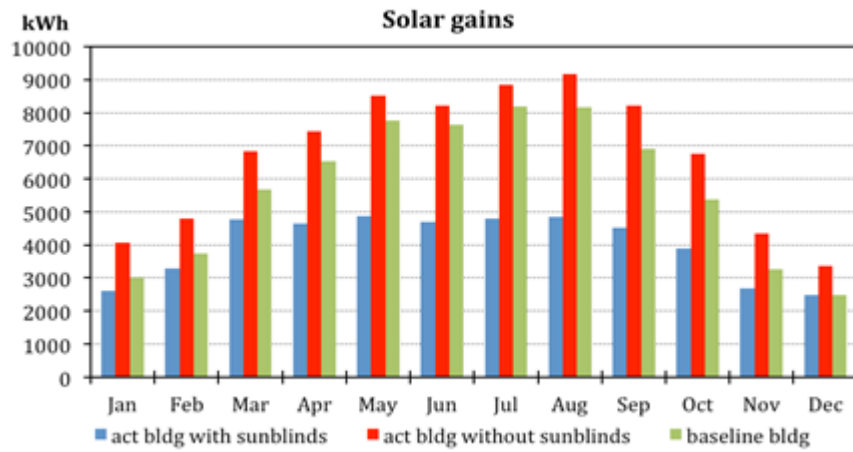

Figure 96: Solar gains for the offices zone, with and without sunblinds (actual building) compared with the baseline building.

9.9 Reuse of ventilation ducts

Mads Mysen, SINTEF
Anna Svensson, SINTEF

Most existing non-residential buildings have Constant Air Volume (CAV) ventilation leading to over-ventilation in periods with low or no occupancy. Demand controlled ventilation (DCV) can considerably reduce the ventilation airflow rate and energy use for fans, heating and cooling compared to CAV ventilation [37].

Conversion from CAV to DCV with reuse of existing ductwork has been done in an office building Norway [40]. The building was originally built in the early eighties and is considered to be representative for a large number of buildings in need for an upgrade. Reuse of existing ductworks was very profitable. The ductwork cost in Solbraaveien 23 was roughly cut in half compared to the alternative which was demolition and new ductwork installation.

9.9.1 The office building Solbråveien

Solbraaveien (Figure 97) is an office building built early in the eighties.



Figure 97: Solbraaveien 23 before and after refurbishment.

It was originally built with CAV-ventilation with reports of annoying noise from the ventilation system. The air inlet was below the windows, blowing upwards with room air induction. Such air inlet is space consuming (Figure 98).

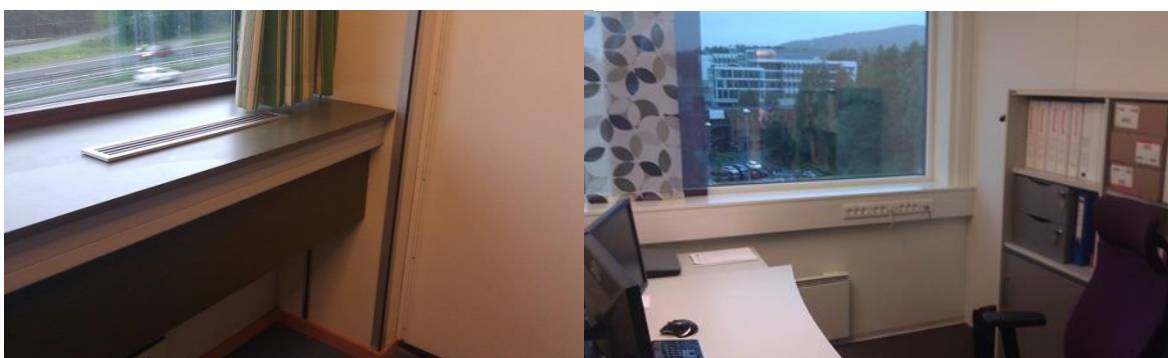

Figure 98: Left, the old air-inlets were space consuming. Right, after retrofitting.

The following main retrofit measures were carried out:

- New air-handling-units
- Conversion from CAV to DCV
- The windows were changed, new U-value of 0,8 W/m²K
- Additional insulation on walls and roof
- Reduced leakage
- Air-water heat pump

Total delivered energy use was reduced from 250 kWh_{fin}/(m²*a) before retrofitting to 80 kWh_{fin}/(m²*a) after retrofitting and the indoor environment was improved [40].

9.9.1.1 Premises and procedure for re-use of existing ductwork

The procedure for re-use is developed by the entrepreneur (GK AS) and SINTEF in the R&D-project UPGRADE Solutions [40]. It is existing ductwork at the "user-side" of the air-handling-unit that is of interest to re-use in upgraded DCV.

A stepwise procedure is shown in Figure 99.

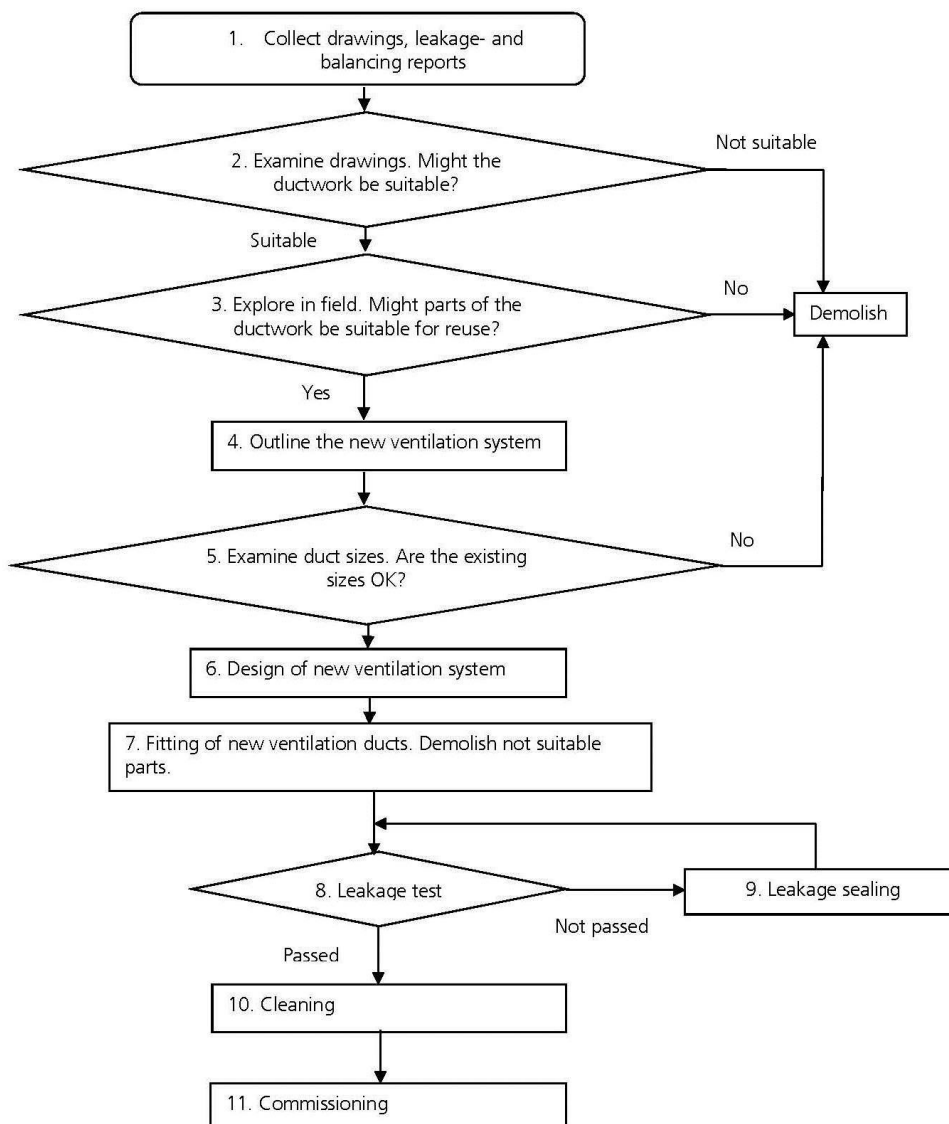

Figure 99: Stepwise procedure for re-use of duct-work.

The ventilation system is upgraded with the use of variable supply air diffusers (VSAD). The DCV-units (same as VAV-damper) are integrated in the air diffusers, making it especially suitable for upgrading to DCV. Figure 100 shows a schematic diagram where variable supply air diffusers are regulated by a controller, and communication is performed via bus.

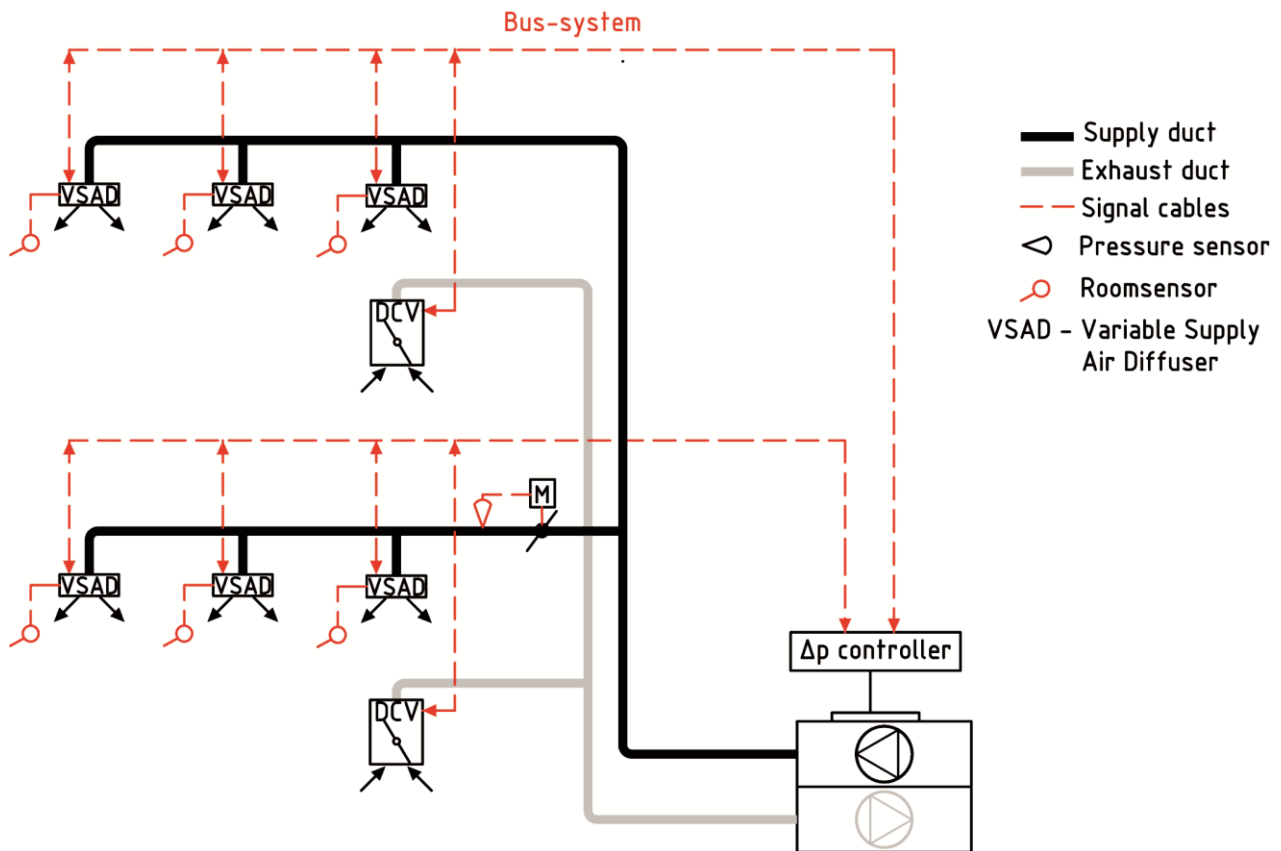

Figure 100: Schematic diagram with VASD regulated by a main controller.

The controller records the required airflow rate, the supplied airflow rate and the damper angle for all the DVC-dampers, and regulates the fan speed such that one of the VSAD is in a maximum open position opened on the supply side, and such that one of the DVC-damper is in a maximum open position on the exhaust side. The integrated motor-driven damper makes sure that the pressure remains in the working range of the VSADs. This damper should normally remain in a maximum open position and only throttle if the pressure in the duct becomes too high relatively to the working range of the VSADs. Such a situation can happen in the branches closest to the fan in large ventilation systems.

VSAD is combined with overflowing arrangement from the offices to corridors and outlets controlled by traditional VAV-dampers.

Table 39: New and re-used parts of the ventilation system after retrofitting.

Ductwork	90-95% is re-used
Air inlets	New VSAD
Air outlets	New, controlled by new VAV-dampers
Air-handling-units (AHU)	New
All ventilation-parts between outside air and AHU (main building air-intake and air exhaust)	New

9.9.1.2 Investment costs for re-use versus new ductwork

Table 40 shows the estimated costs in Solbraaveien 23 compared with a new ductwork-solution. Additional costs related to demolishing or fitting of new duct-work is roughly estimated based on Norwegian prices and experiences from Solbraaveien which has a total net area of 10.000 m².

Table 40: Costs with reuse of ductwork compared with new ductwork.

<i>Activity</i>	<i>Total cost in Solbraaveien (with reuse) [Euro/10.000 m²]</i>	<i>Total costs with new ducts (traditional solution) [Euro/10.000 m²]</i>
<i>1. Collect drawings, leakage- and balancing reports</i>	1 250,-	
<i>2. Examine drawing. Might the duct-work be suitable?</i>	1 250,-	
<i>3. Explore in field. Might parts of the ductwork be suitable for reuse?</i>	1 250-13 000,-	
<i>4. Outline the new ventilation system</i>	No difference	
<i>5. Examine duct sizes. Are the existing sizes OK?</i>	2.500 – 6.000	
<i>6. Design of new ventilation system</i>	0	
<i>7a. Demolish not suitable parts.</i>	19 000,-	150 000 – 200 000,-
<i>7b. Fitting of new ventilation ducts</i>	50.000-62.500,-	400 000 - 500 000,-
<i>8. Leakage test</i>	No difference	
<i>9. Leakage sealing</i>	6.250	
<i>10. Cleaning</i>	112.500 -225.000	
<i>11. Commissioning</i>	0	
<i>12. Unforeseen costs</i>		
<i>SUM</i>	194 000 – 328 000	550 000 – 700 000

This rough estimate shows that reuse was a very profitable alternative to new ventilation ductwork in Solbraaveien 23. Maximum additional cost for reuse was estimated to 40 Euro/m², while the minimum alternative cost for demolishing and installation of new ductwork was estimated to 70 Euro/m². Reduction of the demolishing costs is an important cause of the profitability.

9.9.1.3 Discussion and conclusions

Conversion from CAV to DCV was one of several energy measures carried out in Solbraaveien 23. Total delivered energy use was reduced from 250 kWh_{fin}/(m²*a) to 80 kWh_{fin}/(m²*a), and the indoor environment was improved.

Reuse of existing ductwork might require some compromises when it comes to normal requirements for specific fan power, maximum air velocity, noise generation and leakage. Before considering ductwork reuse, one has to clarify that the building owner has a pragmatic attitude towards such normal requirements.

Furthermore, one must clarify if the ductwork is suitable for reuse as early as possible in the process. Based on the experiences from Solbraaveien 23, it is specified a step by step procedure for reuse of existing ductwork that can be used in all projects where such reuse is considered (Figure 99).

The following success criteria are identified for the successful conversion from CAV to DCV with reuse of existing ductwork:

- Can the original system partition be reused?
- Do shafts have sufficient capacity and availability?
- Does the ductwork have sufficient access and quality?
- Are there any visible corrosion?
- Are there risks for any duct parts with asbestos?
- Is the ductwork sufficiently airtight?
- Are the drawings up to date and easily accessible?

Reuse of existing ductworks was very profitable in Solbraaveien 23. The ductwork cost was roughly cut in half compared to the alternative which was demolition and new ductwork installation. Reuse of the existing ductwork can potentially reduce the refurbishment period and therefore reduce loss of rental income. This is not included in the economical consideration.

9.9.2 The Kampen School

Kampen School is located in a typical city environment in Oslo. Mean annual temperature is about 6°C and winter temperature can be as low as -20°C. Kampen School is a school for pupils from 6 to 12 years with a possibility for 28 pupils in each class. Kampen School was built 1888 and renovated 2002. The total floor area (m²) is 4500 m² and number of pupils in total is approximately 400. The school has 30 classrooms with an approximate size of 65 m² and typical windows area of 15 m².

The school has two main buildings and was originally designed with natural ventilation with ground-coupled fresh air ducts and vertical air stacks, but had been rebuilt, probably in the 60's, to a duct based mechanically balanced constant air ventilation system providing a standard classroom of 60 m² with approximately 120 liter/second of fresh air [41]. Such classrooms are designed for a maximum of 30 persons. The Norwegian Building Code recommends at the time about twice as much fresh air per classroom.



Figure 101: The east facade of the two main buildings before retrofitting.

Kampen School was partly retrofitted in 1978 and the windows were changed in 1998/1999. It was decided that exterior, including cladding, insulation and windows, should be kept unchanged during this retrofitting, because it is considered of sufficient quality. The main purpose with this retrofitting was to improve Indoor Environment Quality (IEQ) with energy efficient ventilation and lighting and considerably reduce energy use at the same time. The improved ventilation airflow rates must be in accordance with or

better than the Building Code and national ventilation standard which accept CO₂-level up to 1000 ppm.

Kampen School is a listed building of historical value and the retrofitting should be in harmony with the buildings architectural expression (Figure 101). Life Cycle Costs calculated at an early stage of the project showed that hybrid ventilation was the best economical alternative for this project. Retrofitting of Kampen School was a case study in IEA Annex 36 [42].

9.9.2.1 Methods improve ventilation and lighting system

The original building had an integrated ventilation solution from 1888. This solution had air intake at each end of the building, ground-coupled ducts and vertical shaft. Because of traffic pollution, there was built a new air intake on the top of the new connection building (Figure 102). The air passes through a filter and a run-around heat recovery battery with low pressure drop, and then via the original ground-coupled concrete duct, under the building, finally toward separate vertical shafts to each classroom. The new ventilation system is based on fan assisted natural ventilation, or hybrid ventilation.



Figure 102: The east facade after retrofitting with the new connection building and new air intake at the top.

The thermal mass of the intake tower, ground-coupled concrete duct and vertical shafts will provide a considerable amount of cooling on hot days if they are cooled down by means of night-ventilation [41].

The rooms are ventilated with displacement ventilation through a new inner wall (Figure 103). The inlet for supply air is placed behind the new wall in the corner (Figure 103 pos 0-2,0). A shelf under the air inlet and the shape of the new inner wall was designed to spread the air equally along the long side of the classroom through a perforated zone in the lowest metre height of the wall (Figure 104). The pressure drop through the perforated plate is hardly measurable (< 1 Pa).

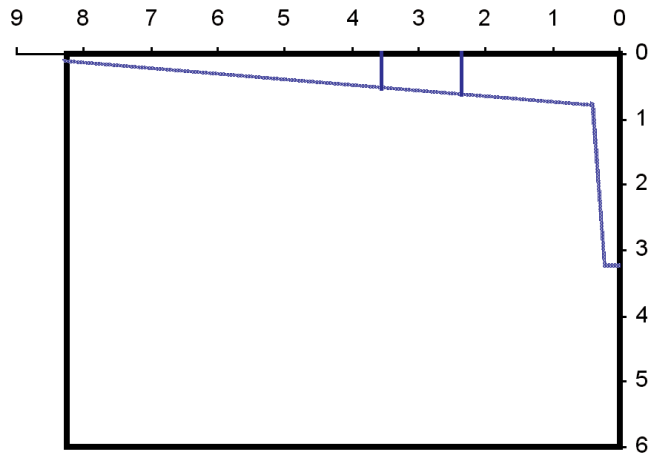

Figure 103: Plan of an original classroom and the new inner wall. Measurements in metres.



Figure 104: Smoke tests were done in laboratory (upper picture) and at site: the tests showed even distribution of supply air from the perforated wall. Maximum measured air velocity was 0.2 m/s.

During normal conditions, the classroom has a considerable heating load. It is a challenge to ventilate for this heating load without getting problems with drafts. A laboratory study with a full scale test indicated that the supply air temperature will increase about 2°C from the inlet behind the integrated wall to the air inlet in the room. This means that the new integrated wall will serve as a cooling panel, making it possible to add some extra cooling to the ventilation air. The new integrated wall will also serve as an acoustic dampener for the room.

The exhaust air will pass through vertical exhaust shafts with a heat recovery battery at the top. The control system is a supervisory control (BEMS). In principle, operation is by a centralised system. The type of management is internal by caretaker, or remote via a modem.

Ventilation demand in the classroom is controlled by a combined CO₂- and temperature sensor placed on the inner wall in breathing height, controlling motorised blade dampers which are all located in the culvert for easy access for maintenance.

When the CO₂- level or the temperature in the room rises above the set-point values 900 ppm or 22°C, the damper opens up. If the CO₂-level or temperature increases further up to 1000 ppm or 24°C, the fans gradually speeds up. The set-points are easily adjustable.

The windows in the classroom are 2.3 m high, from 1.2 m to 3.5 m above the floor. The room is 3.6 m high. The windows are split in two with a 0.5 m deep shelf placed 2 m above the floor, as seen in Figure 105. Most of the sunlight coming through the window above the shelf will be reflected on to the ceiling and give light to the room so that sunlight above the shelf cannot cause glare in the classroom. Glare from the sun below the shelf is handled by use of curtains. When all curtains are in use, the daylight factor is about 1% on average.



Figure 105: Simulated sunlight in a classroom with shelves and curtains [41].

The old lighting system had nine 2x65 W luminaires mounted on the ceiling, with manual on/off switches. There was no blackboard lighting. The lighting is improved with new shelves reflecting daylight and sunlight further in to the room. The new artificial lighting system is based on suspended pendants 2x36W with high frequency ballasts. The light distribution ratio is 70% upwards and 30% downwards. The blackboard is lit with three luminaires of 1x 36W.

A manual switch and an Infra-Red (IR) movement detector control the suspended pendant luminaires. In order to switch the lights on, it is necessary to use the switch, but the IR detector may turn off the lights if there is no movement in the room. In this case it is necessary to turn them on again by the manual switch. The idea is that the lights will only be turned on if daylight seems insufficient.

9.9.2.2 Reduce energy use

Energy use before retrofitting and after windows replacement in 1999, was 297 kWh/m² in 2000 and 256 kWh/m² in 2001. Corresponding temperature adjusted average was 281 kWh/ (m²*year).

The energy use after retrofitting was calculated to 169 kWh/ (m²*year). The calculated energy savings are due to:

- Improved control of radiator heating because of new thermostatic valves
- Reduced fan power energy because of optimal use of natural driving forces
- Demand controlled ventilation with heat recovery
- Demand controlled artificial lighting which means maximum use of daylight and minimum use of artificial lighting

9.9.2.3 Results

Measured temperature adjusted energy use varies from 132 to 163 kWh/m² with an average of 151 kWh/ (m²*a) in the period 2006-2011.

Pupil's at Kampen School in total had significant improvement of the concentration test scores and health and well-being questionnaires compared to a control school [43].

The schools caretaker is satisfied. He claims that there are few complaints among the staff and the pupils and the demand controlled ventilation and lighting systems are well functioning (oral discussion with Jon Andreassen, January 2012).

9.9.2.4 Discussion

The main purposes with this retrofitting were to improve Indoor Environment Quality (IEQ), improve the learning and teaching environment and reduce energy use considerably. The evaluation indicates that this is achieved. Health and well-being among pupils seems to be improved, performance test scores are significantly improved, and the energy use is considerably reduced. This is achieved with a listed historical building in a city environment. The choice of hybrid ventilations system is done due to the given premises with existing ground-coupled ducts. Demand controlled ventilation with even more energy efficient heat recovery like rotating wheel, would be a natural choice for a new building.

The energy use is reduced with approximately 40-50 %. Some of the reduction might be probably caused by increased building area built in a more energy efficient way than the original buildings. However, the results demonstrate the huge potential of energy reduction with demand controlled ventilation and lighting. The ventilation airflow rates are probably increased at least two-fold in classrooms with 30 persons present.

Retrofitting of Kampen School won the Norwegian HVAC prize in 2004.

9.10 Photovoltaic panels

Diego Arroyo, University of Sydney
Richard Hyde, University of Sydney
Nathan Groenhout, University of Sydney

9.10.1 Introduction

Renewable energy sources are increasingly playing an important role in energy generation across the world as they can provide reliable, clean energy with minimal environmental impact. The question this paper attempts to address is how we might expand the role of renewable energy through retrofitting of buildings to power our cities and other developments. Australia has an energy plan for year 2020 which aims to supply 20% of total generated energy from renewable sources [48]. Initiatives like the Zero Carbon Australia Building Plan [47] advocates for 100% of Australia's electricity provided from renewable sources, in part by moving to zero-emissions buildings. This is achieved partially through the installation of Photovoltaic (PV) panels in residential and non-residential buildings. The climatic conditions in Australia provide outstanding conditions for PV with solar irradiation comparable to the best sites in the world for solar power harvesting [48].

The following article aims to review the current situation on PV solar technology in Australia as it relates to the renovation of non-residential buildings.

Renewable energy sources, such as solar photovoltaic, wind, tidal, geothermal and biomass present a range of benefits including: a decrease in greenhouse gas (GHG) emissions, a reduction in transmission losses, size adjustability and almost immediate power [55]. Furthermore, the renovation of existing buildings is seen as a significant opportunity to achieve reductions in GHG emissions as stationary energy use in buildings is a major contributor to our energy footprint and the general poor performance of the existing building stock presents 'low hanging fruit' for energy improvements. Therefore the combination of renewable energy sources with the renovation of existing buildings presents a sweet spot for GHG reduction.

There are a range of factors and conditions in the Australian context that indicate solar PV technology can be one of the most suitable renewable energy sources when renovating buildings. The following discussion presents an overview of these factors as they relate to current policies and programs, technologies available for PV installations, successful demonstration projects, funding options for non-residential uses, along with the main barriers and opportunities that further PV development would face in the next stage of development and implementation.

9.10.2 Policies and Programs

The Australian Photovoltaic Institute (APVI) states in their 2012 report that there will be growth in the commercial sector in coming years after a period of relative consolidation of the PV market in Australia, due to initiatives that came into effect in 2009, reaching its peak during 2012, the year where most of the small scale initiatives ended. [46]. The 2013 APVI report highlighted a contraction in installed capacity over the previous year due to market incentives being reduced or removed. Whilst the costs of PV modules are reducing, the economic barriers continue to increase. Increases in the cost of grid connected electricity, should improve the attractiveness of PV into the future, however [46].

The Australian Government's Renewable Energy Targets is the main mechanism supporting renewable energy generation in Australia, with the program aiming to progressively achieve a production of 45,000GWh by 2020 through the use of renewable sources, incrementing installed power on a yearly-basis. The program is split into two parts: the

Large-scale Renewable Energy Target (LRET) and Small-scale Renewable Energy Scheme (SRES). The LRET covers major projects such as wind farms and commercial scale solar and has a legislated target of 18,850 GWh in generated in 2015, whilst the SRES targets smaller, building scale installations (up to 100kWp). Both programs work under a mechanism of tradable certificates for eligible, accredited and registered renewable energy sources, which produces certificates for each MWh of energy produced. The goal for large-scale installations is to create a market for renewable energy, whereas for small installations is to reduce their initial capital cost.

The operation of large-scale PV installations are expected to start in 2014 [52], these installations are mainly in the form of large centralized array of PVs. They have a longer and complex process to start their operation compared to small-scale installations, which are able to be operative almost as soon as the programs of subsidies, grants and rebates commence.

An additional and indirect implication on the growth of PV in the commercial sector, particularly in commercial buildings, is the market for rated buildings under schemes like Green Star and / or NABERS. Green Star is a voluntary sustainable design rating tool using a six star scale, developed and managed by the Green Building Council of Australia and is similar to the LEED and BREEM rating schemes in the US and Europe. NABERS is the National Building Energy Rating Scheme, a rating tool that assesses operational performance of existing buildings on a six star scale. It also forms the assessment tool for the CBD Disclosure Program that requires all commercial buildings over 2,000m² to publicly disclose their energy performance at sale or lease.

The integration of PV systems into buildings can help achieve a higher rating, which in turn, leads to better market returns as well as the obvious benefit of enhanced environmental performance of the building. In addition to increasing a building's environmental performance and its market value it can also assist in avoiding their obsolescence [54]. These reasons support the interest in the use of energy from renewable sources within non-residential buildings.

The Green Star rating system awards credits for green power and recognises it as a valid measure for reducing greenhouse gas emissions [50]. Benefits from PV installations and the use of solar generated power are not restricted to buildings with installed solar arrays. The option of purchasing green power – even more specifically from PV generated power – produced in a remote location, can provide clean energy for buildings where the physical constraints of the site, heritage constraints, environmental constraints or building structure make solar PV installations not feasible, either for technical reasons or due to planning constraints. Heritage buildings are a particular building type that could gain benefit from sourcing green power without the need of altering and adding additional elements that can potentially reduce or impact the heritage value of the building. In many areas, local and state government impose control plans restricting how our built heritage may be used, modified or replaced with the aim to retain significant historical structures without altering the inherent value of their form, height, materials, layout and fabric [45], [47].

9.10.3 Installed Power, Technology and Connectivity

The share of electricity produced from PV is relatively low compared to other renewable energy sources in Australia and currently accounts for around 2.3% percent of all energy generated [52]. The total production from PV was 3.225 GWp in 2013, with most of this production coming from small-scale PV (less than 10 kWp), grid connected installations - 99% in 2012. The proportion is expected to change as many large-scale projects commence operation in 2014 and beyond [51].

One important consideration is the degree of connectivity to the main electricity grid. With non-residential buildings, the options are either grid-connected, with distributed or centralized PV power systems or off-grid non-domestic systems. Grid connected PV currently represents over 95% of all installed PV in Australia [46].

In Australia, the PV market is defined as all PV installations with a minimum installed power capacity of 40W, with interconnected components such as: panels, inverters, storage batteries, controls and meters [46]. The systems directly applicable in refurbishment of buildings can be conventional roof top mounted systems, façade mounted systems, and also BiPV (building integrated photovoltaics). BiPV is of particular interest due to it being able to become part of a holistic approach in developing architectural design solutions, serving the dual function of meeting the energy requirements of the building, as well as contributing to and improving the aesthetic qualities of a building [55].

9.10.4 Demonstrative Projects and Research

State governments, the Commonwealth Government and industry have invested more than AUD\$400 million (€270 million), either in small and large scale generation projects, for example the co-operation between Bluescope Steel and The Australian Centre for Renewable Energy, developing building materials integrating photovoltaics and the Solar Flagships project for large scale solar plants [46].

Demonstration projects and field tests represented the largest investment with 54% of public funding, followed by market incentives (27%) and research and development (22%) during 2012 [46].

Educational buildings are one of the main building types used for demonstration and have been one of the main targets for government funds for photovoltaic installations [46]. This type of building allows a strong diffusion of knowledge by integrating technology development and educational programs around PV technologies. They not only support installations which can cut energy bills, but also create learning platforms for students. Additionally they can also provide environmental stewardship for institutions holding them. The following three projects illustrate this point.

First, The University of Queensland has installed the largest rooftop mounted PV installation in Australia, integrated within four buildings in its St Lucia campus, in Brisbane, Queensland, Australia. In 2013, the University was also granted additional funding of over AUD\$40 million (€27 million) to increase the existing capacity from its current 1.22MW to 3.3MW [59].

Second, The University of New South Wales has also recently developed a new energy technology building in late 2012: The Tyree Centre, with an installed PV array of 150kW capacity, funded from public and private contributions. This building not only provides power for the facility but also houses a research centre related to photovoltaic technology development, and further supports their undergraduate and post graduate teaching programs at the School of Photovoltaic and Renewable Energy Engineering (SPREE) [46].

Third, the National Schools Program is a program offering grants up to AUD\$50,000 (±€35,000) to incorporate any renewable energy technology into existing schools. Under this program, the largest preference for renewable energy systems turned out to be PV systems - 90% of the 804 institutions granted funding decided to install photovoltaics rather than other renewable energy systems.



Figure 106: University of Queensland PV array, left UQ centre building, right Multi Level Carpark 1.
Source: <http://www.uq.edu.au/solarenergy/pv-array/st-lucia>

9.10.5 Subsidies, Grants and Rebates Benefits

A broad array of funding options has been available as incentives to support the development of PV systems. For non-residential uses support was previously found in the form of capital subsidies, feed-in-tariffs, tax credits, net billing and / or metering. These measures helped either with initial capital costs, as well as ongoing benefits via retail price paid to the owner of the system when delivering power to the grid. Currently most of these benefits have been removed or at least substantially reduced, and some may argue that the sector has reached a point of self-reliance, no longer requiring excessive subsidies to prop up research, development and commercialisation. A consequence of these benefits to date has resulted in the cost for modules and associated equipment for both off-grid and grid connected systems have lowered by as much as 70% between 2008 and 2012 [46]. This has resulted in household scale and larger systems being more affordable, and will become increasingly so as the cost energy from conventional fossil fuel sources continue to rise. This is a complex area as energy generators and retailers fight for market share in what is a decreasing overall demand for energy due to the up-take of energy efficiency measures across markets.

9.10.6 Barriers

According to Trudgill, there are five important barriers to the development of a better environment, namely the lack of priority, appropriateness, lack of appreciation, lack of prerequisite knowledge, and affordability [58].

The main barrier PV installations face is economical. As the use of PV reduces energy sales in the traditional energy market, measures like net-metering are removed, imposition of levies and system size constraints appear which work to dis-incentivise the use of solar power [52], [58]. Feed-in tariffs also are subject to reviews [47]. The removal of subsidies and grants by state governments and the reduction in benefits from federal government constitutes a barrier to the development of solar generated power. In addition there are barriers related to contradictory benefits or split incentives that discourage the use of photovoltaics, for example in the case of leased properties where the capital investment is funded by landlords, while the tenant gets the economic benefit of reduced outgoings through reduced energy consumption [47].

A second type of barrier is found around technical issues such as the difficulties faced by the network to manage fed-in power and over-voltage. For PV to form a credible option in the renovation of existing buildings end users and consumers need to a higher level of education around key issues – including barriers to implementation and the industry has a major role to play in education and integration.

Finally, there are constraints associated with local council planning schemes, where PV installations can be declared as intrusive elements, particularly in the case of conservation areas and buildings in cities [60].

9.10.7 Opportunities

Opportunities for PV development in non-residential buildings exist across a number of aspects which relate to the affordability, appropriateness and appreciation for PV systems. These aspects, which where once may have been considered barriers, are now seen in a more positive light. These include:

- There is a market already developed for PV systems, allowing for different types of installations including large and small scale, as well as stand-alone or also grid connected systems.
- Organisations dedicated to the research, development, support and promotion of PV technology, including private and publicly funded institutes. For example, ARENA (Australian Renewable Energy Agency), APVI (Australian Photovoltaic Institute) and the Australian Research Council.
- Demonstrative public projects that have been successfully implemented solar PV technology either in stand-alone installations, or as large grid-connected systems to supply electricity to clusters of buildings, such as the examples at UNSW and The University of Queensland. Educational buildings play an important role in the development and promotion of PV technology, as they have become platforms for the dissemination of positive information to the market.
- Case studies of sustainable retrofitting using an integrated approach for photovoltaic installations being widely available. One such case study by Pollard shows that it is possible to improve the NABERS rating using PV retrofitting. He found in the case study that using the roof area of a slab block, ten per cent of the non-renewable energy could be displaced by the PV system. However, the financial viability of such arrangement is heavily reliant on subsidies [53].
- There is a now a legal framework and a mature technology developed allowing the use of solar generated power wisely. Grid connected, net-metering and fed-in power are examples of the available choices to use PV power.
- The cost per kW of PV systems has reduced within recent years due to the many policies and programs created by governments to boost the PV market.

9.10.8 Conclusions

The current development of photovoltaic systems shows it to be a maturing technology, which has been used widely in the local Australian context for more than twenty years. The development of photovoltaic systems has been achieved both at large and small-scale, creating systems that can feasibly be incorporated into both new and existing buildings in three different ways: as rack mounted panels, as integrated components (BiPV) and also through the purchase of green power from remote large-scale PV plants.

Barriers still remain, however, to a broader uptake of photovoltaic technology in the retrofitting of existing non-domestic buildings. The scale of energy demand in these types of buildings makes it hard to achieve site base efficiencies and return on investment using PV. Under current conditions, the greatest barrier to PV uptake remains economic considerations.

Green Power, delivered from both small and large-scale PV installations, allows for the offset of emissions from other fuel sources, and thereby can increase the capital value of an individual property, as a consequence of a potential higher ranking in schemes like the Green Star rating tool.

Demonstration projects have successfully showcased examples where the use of PV in educational buildings, with the opportunity to taken advantage of educational campaigns, have improved the understanding of, and built the pre-requisite industry knowledge required for the successful retrofitting of PV to existing buildings.

The Australian PV Association argues that PV use in non-residential buildings is yet to peak, and consequently the flexibility of implementation of PV systems within this sector strongly suggests PV as a feasible and suitable renewable energy option in the renovation and retrofitting of existing buildings.

9.11 Listed Buildings

Claudia Dankl, ÖGUT
Anna Svensson, SINTEF

Energy efficient renovation projects are more demanding than building new buildings. Regarding listed buildings, this is one more challenging to find good solutions without reducing the historical values of the building.

9.11.1 NVE-bygget, Norway

9.11.1.1 Introduction

“The NVE Building” is a monument and cultural heritage of post war Norway. The partly protected building was in need of total rehabilitation, which should pay attention to protection restrictions, existing architectural qualities and modernization, as well as to energy efficiency improvement, the environment in general and universal design. The aim was to show that it is possible to combine these aspects in a comprehensive upgrade. Middelthuns gate 29 was constructed from 1962 to 1964 for NVE. The building is divided in a cellar, lower ground floor, 6 office floors and a smaller 7th floor.

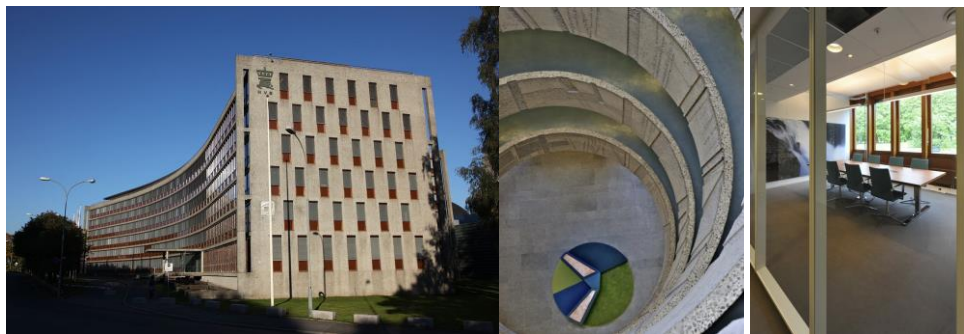

Figure 107: NVE building after renovation

9.11.1.2 Protection

NVE building was protected by the Directorate of Cultural Heritage by regulation in 2011. Protection order was conducted in parallel with the renovation. The purpose of the protection is on preserving the building's architectural expression and character. In the process, it was a close dialogue with the Directorate who participated in the entire process and helped finding acceptable goals and solutions. It was important for Cultural Heritage to preserve the items that were listed, and it was important that conversions, upgrades and repairs in the protected areas, were made of the same materials, shape, feel and quality as the original. The Directorate was positive to measures to reduce demand for energy. Many of the solutions arrived at through discussion between those involved. A major challenge was to find good solutions for materials and products that could not be replaced (teak, asbestos, PCB).

Protected elements were both exterior and interior, which means:

- The building's exterior was maintained. The architectural appearance, materials and detailing that façade solution, older doors and windows, surfaces and any decor be preserved intact.
- Inside the main structure, including parent and the original or an older room structure, floor slabs and other structural elements shall pass.

- Protected interior is preserved similarly with architectural details such as doors, windows, moldings and surfaces and any decor and fixtures. Light fixtures character of the building preserved as part of the protection.
- The outdoor areas are preserved and the functional and visual relationship with the listed building should be maintained.

9.11.1.3 Measures

The following main renovation measures were carried out:

- Extension and redesign of the 7th floor and roof
- VAV ventilation, 81-82 % heat recovery
- Air intake for ventilation system in outside garden with air through ground ducts to improve heat recovery.
- Improved SFP 1.57 W/m³ at 80 % air flow (calculated according to NS3031)
- Some insulation measures on the interior wall behind radiators
- Replaced window panes to krypton glass, changing the total U-value for windows from 2,5 to 1,3 W/m²K

Other measures:

- NVE changed their indoor climate requirements and accepted more hours with temperature above 26°C degrees.
- New automatic external shading devices were installed, to reduce overheating during summer
- Energy efficient lighting with daylight control
- Replacement of electrical heating to district heating with radiators.
- Re-use of existing teak doors (as new doors or material component)
- Good environmental profile on all new materials, documentation through BASS.
- Environmentally certified products for interior and furniture.
- All woods from sustainable forestry and no use of (new) tropical woods.
- Use of minimum 30% recycled aluminum and 50% recycled steel.
- Water saving sanitary equipment.
- Universal design according Norwegian code for new office buildings.
- Minimum 85% of building waste shall be separated on site.
- All hazardous materials for demolition identified in environmental redevelopment scheme.

9.11.1.4 Economy

The project got financial support from ENOVA (public enterprise for state funding, Ministry of energy and petroleum) for conversion from direct electric heating to district heating.

9.11.1.5 Results

The energy ambitions were upgraded from class C to class B during the project period because B turned out to be within reach (due to better air tightness). The NVE-building is the first listed building in Norway which is upgraded to energy label B.

9.11.2 Kampen skole, Norway

Kampen School was built 1888 and renovated 2002. The total floor area (m²) is 4500 m² and number of pupils in total is approximately 400. The school has 30 classrooms with an approximate size of 65 m² and typical windows area of 15 m².

Kampen School is a listed building of historical value and the retrofitting should be in harmony with the buildings architectural expression (Figure 108). Life Cycle Costs calculated at an early stage of the project showed that hybrid ventilation was the best economical alternative for this project. Retrofitting of Kampen School was a case study in IEA Annex 36.

The main purpose with this retrofitting was to improve Indoor Environment Quality (IEQ) with energy efficient ventilation and lighting and considerably reduce energy use at the same time.

More about the measures is found under chapter 9.7.3.3.



Figure 108: The east facade long before, and after renovation.

10 Lessons Learnt

In the following, important aspects and lessons learnt from the case studies in the participating countries are described and emphasized.

10.1 Denmark

Denmark has contributed to the IEA SHC Task 47 work with 4 different case studies. The case studies have involved a wide range of different technical solutions and this has given insight to their individual strengths and weaknesses. Below is a short description of the lessons learnt for each individual Danish case study.

10.1.1 General

The Danish Building Regulations incorporate definitions of future low-energy classes for many years to come and this has been a great success. BR10 contains definitions of Low-energy Class 2015 and Building Class 2020 for buildings and having these predictions of future energy performance requirements, the Danish industry knows at least 10 years in advance of the coming requirements and is able to adapt their products to the new demands.

This is one of the reasons why new very energy-efficient components are normal today on the market, e.g. windows, fans and heat pumps. In general, it is voluntary to build following the future low-energy classes, but several local authorities have rules that stipulate that a certain low-energy class should be applied in their municipality.

10.1.2 Osram Culture Centre, Copenhagen, Denmark

The indoor climate of the building was improved significantly by the renovation process. Daylighting levels in the building were raised by introducing roof windows that would both help raise daylight levels on the first floor and on the ground floor.

The indoor air quality has also improved significantly by the introduction of a combined mechanical and natural ventilation system. The mechanical system has heat recovery and will ventilate the building during winter. When indoor temperatures or CO₂-levels in the building get too high, the automatic natural ventilation will be initiated (opening of roof windows).

The lighting systems in the building have also been improved. The general lighting system has been fitted with automatic control, so that the electric lighting is dependent on daylight levels in the building (there is a manual override to this function).

10.1.3 Kindergarten Vejtoften, Høje-Taastrup, Denmark

The indoor climate has improved dramatically as a consequence of the facade insulation, new windows and insulation of the foundation. The facade insulation and new windows have significantly reduced thermal bridges around windows and the airtightness of the building envelope has increased. The overall effect is a building with less draught and a generally improved thermal comfort.

The indoor air quality has improved due to the new ventilation system. The new ventilation system has a higher heat recovery rate and thereby the system is less likely to generate draught during the cold winter season.

The quality of life has also been increased significantly in the kindergarten. Now the occupants (children and staff) are able to use the entire floor area during winter. Before the renovation the floor area near exterior walls and windows were too cold reducing the useable area. The new windows, extra insulation in the walls and insulation of the base have reduced the heat losses and removed draught near windows and thermal bridges at the building base.

10.2 Germany

The convincing case studies in Germany show that the energy performance of the buildings and the interior thermal comfort can be significantly improved after the retrofit. The data acquired from scientific evaluation makes these pilot applications into models for consistent building refurbishment. Two technologies, i.e., prefabricated façade systems and ground-coupled heat pump systems, had been studied in greater detail.

10.2.1 Prefabricated Façades

The integration of ventilation systems in the façade is one solution to avoid cumbersome air ducts inside dwellings, simplifies the work by avoiding core holes and allows using the rooms during the work. The integration of ventilation ducts in prefabricated façade and window elements is a promising solution to lower the costs of retrofit measures and thereby increasing the renovation rate. Furthermore, it makes the installation easier and the buildings can be used during the retrofit measures as almost no work has to be done inside the buildings as it would be the case if conventional ventilation system would be installed.

10.2.2 Ground-coupled Heat Pumps Systems

From the results of the field testing of heat pumps in new and existing buildings it can be confirmed that -depending on the environmental energy source employed and the building standard- energy savings of up to 50% are possible compared to conventional gas or oil boilers. With the increasing proportion of renewable energy sources for the generation of electricity, the primary energy assessment of electrically powered heat pumps is becoming increasingly favourable. Despite higher investment costs, sales figures in recent years confirm the positive development of heat pumps.

Analyses for the composition of a future, almost climate-neutral energy system of Germany, aiming at lowest possible total cost, show that electric heat pumps will play a central role in supplying heat. But how efficient are heat pump systems today in real operation for the heating and cooling of non-residential buildings? Therefore, the energy and efficiency performance of 16 large heat pump systems with a thermal power between 40 and 322 kW_{th} was assessed in detail based on multi-annual measurement campaigns within the framework of the BMWi-funded programs EnOB and LowEx:Monitor. For the heat pump systems (considering compressor and primary pump), seasonal performance factors from 2.3 to 6.1 kWh_{th}/kWh_{el} (source ground) and 2.9 to 4.3 kWh_{th}/kWh_{el} (source groundwater) have been achieved. The use of ground-coupled reversible heat pumps for cooling is also an efficient and sustainable approach to cooling building. Here, the relatively high supply water temperatures of 16 to 20 °C allow for cooling with good energy efficiencies. Seasonal performance factors for the cooling mode (heat pump system) from 2.1 to 5.0 kWh_{th}/kWh_{el} were demonstrated in the projects.

10.3 Austria

In general changing controls and developing innovative control methods for building management systems proves to be a cost effective measure to improve the energy efficient HVAC operation in building management systems. There are basically two ways: either on the process level, where obsolete local controllers are replaced by model based process controllers, or on the energy management level which allows for a more robust and stable HVAC control operation. Additional information about the weather as well as load profiles about the energy consumption through building occupants can have a crucial impact on the model based energy management performance. The slow building thermodynamics allow for real-time online optimization on the energy management level particularly.

10.3.1 Modernization of Box Type Windows

With the help of two-dimensional CFD simulations the thermal behaviour and the characteristic of air flow inside a box type window could be determined. The CFD outcome did match with the results from in-situ measurements. A circulation of air in the box type windows cavity could be observed. It was possible to create a virtual hot box for the determination of U-values for some promising modernization concepts. The results from this analysis showed that modernization measures can improve the thermal protection of historical box type window significantly.

10.3.2 Internal thermal insulation

The investigation of different internal thermal insulation systems showed that the described disadvantages of the different systems lead at some construction details to borderline conditions. But every internal insulation system is suitable for the analysed construction details (except the construction details with connection to ground). Although because of stability and safety of the behaviour, the system Multipor is preferable.

11 Publications

11.1 AIT:

T. Ferhatbegovic, S. Hauer, and G. Zucker, "Methodology for deploying model based control concepts for load shaping in the non-residential building sector," in *IECON 2013 - 39th Annual Conference of the IEEE Industrial Electronics Society*, 2013, pp. 5735–5740.

T. Ferhatbegovic, G. Zucker, F. Judex, R. Braun, S. Hauer, S. Leal: "Thermal Building Modeling Supports Building Controls"; Vortrag: 8. Internationale Energiewirtschaftstagung, Wien; 13.02.2013 - 15.02.2013; in: "Erneuerbare Energien: Überforderte Energiemärkte?", TU Wien, Vol. 8 (2013), S. 125 - 126.

T. Ferhatbegovic, S. Hauer, I. Leobner, K. Ponweiser, A. Schirrer, M. Kozek: "Thermal Building Modeling and Simulation for the Automated Load Shifting Purposes in the Non-Residential Building Sector", ECPPM 2014. Manuscript submitted for publication.

11.2 Denmark:

Bygningsreglementet (BR10), Erhvervs- og Byggestyrelsen, 2010.

Danish Building Regulations 2010 in English: www.bygningsreglement.dk (link to PDF-file)

SBi Direction 213: Energy demand in buildings (In Danish at: www.anvisninger.dk - requires license for download)

Case Study: Osram Culture Centre, Copenhagen, Denmark.
<http://task47.iea-shc.org/data/sites/1/publications/Osram-Building-Denmark.pdf>

Case Study: Office building, Roskilde, Denmark.
<http://task47.iea-shc.org/data/sites/1/publications/Office-Building-Roskilde-Denmark.pdf>

Case Study: Kindergarten Vejtoften, Høje-Taastrup, Denmark.
<http://task47.iea-shc.org/data/sites/1/publications/Kindergarten-Vejtoften-Hoje-Taastrup-Denmark.pdf>

Case Study: Rockwool International Office Building "Center 2", Hedehusene, Denmark.
<http://task47.iea-shc.org/data/sites/1/publications/Rockwool-Office-Building.pdf>

Velux Website: http://www.velux.com/sustainable_living/demonstration_buildings/osram

11.3 Germany

Herkel, S.; Kalz, D.; Sonntag, M. (2014) *Successful Retrofit of non-residential buildings: heating and cooling concepts. International Conference on Solar Heating and Cooling for Buildings and Industry*. October 13-15, Beijing, China.

Kalz, D.; Herkel, S.; Klein, K.; Winiger, S. (2014) *Energetische und energiewirtschaftliche Analyse von Wärmepumpen für die Wärme- und Kälteversorgung von Nichtwohngebäu-*

den. *EnOB-Symposium 2014 "Energieinnovationen in Neubau und Sanierung"*. March 20-21 2014, Essen Germany, Zeche Zollverein.

Kalz, D.; Winiger, S.; Sonntag, M.; Herkel, S. (2014) *Felduntersuchung von erdgekoppelten Wärmepumpen für die Wärme- und Kälteversorgung von Nichtwohngebäuden: Analyse der Energie- und Effizienzperformance*. Submitted for publication in Ki.

Coydon, F.; Duran, M.; Dinkel, A.; Herkel S. (2013) *Rapid Retrofit Solutions Integrating HVAC into Prefabricated EWIS Systems*, in *CLIMA 2013: 11th REHVA World Congress & 8th International Conference on IAQVEC 2013*: Prague.

Coydon, F., Dinkel, A., Kagerer, F., Herkel S. (2014) *Monitoring results and optimization of a façade integrated ventilation concept for building retrofit*, in *35th AIVC Conference 2014*: Poznań.

11.4 Austria

BOX TYPE WINDOWS

Brandl, D., Mach, T., Grobbaauer, M., Ruisinger, U., Hochenauer, C., Analysis of Natural Convection and Heat Transfer for Traditional Box Type Windows, *International Journal on Energy Conversion* (ISSN 2281-5295), Vol. 1, N. 6, 2013.

Brandl, D., Mach, T., Grobbaauer, M., Ruisinger, U., Hochenauer, C., Analysis of the thermal behaviour of historical box type windows for renovation concepts with CFD, *Sustainable Building Conference 2013* (ISBN 978-3-85125-301-6), pp. 181-194

BRANDL, D., MACH, T., GROBBAUER, M., RUISINGER, U., Thermische und strömungstechnische Untersuchung zur Ertüchtigung historischer Kastenfenster im Rahmen des Projekts denkmalaktiv, Vortrag im Rahmen des GovernEE Energy Day, Fachtagung zu Energieeffizienz und Denkmalschutz, Franziskanerkloster Graz, 25.10.2012

RUISINGER, U., MACH, T., KAUTSCH, P., GROBBAUER, M., denkmalaktiv I – Sanierung alter, historischer Gebäude auf Aktivhaus-Standard? Baustein: Sanierung historischer Kastenfenster, Vortrag und Abstract, Internationale Konferenz für hochwertige energetische Sanierung, Graz 2011

INTERNAL INSULATION

RUISINGER, U., GROBBAUER, M., KAUTSCH, P., Kastenfensterlaibung und Holzbalkenkopf mit Innendämmung. zwei Detailpunkte im Fokus, 2. Innendämmkongress, Dresden, 12.-13. April 2013

KAUTSCH; P, Thermische und akustische Performanceverbesserung im Bestand, OEKO-ID - Innendämmungen zur thermischen Gebäudeertüchtigung und denkMALaktiv - Sanierung alter denkmalgeschützter Gebäude auf Aktivhaus-Standard?, Österreichischer Städtebund, Wels, 19.04.2012

GROBBAUER, M., RUISINGER, U., Innendämmung, Holzbalkenköpfe und Kastenfenster in der Sanierung, bauphysiktagung 2012, an der Technischen Universität Graz, 15. November 2012

12 References

- [1] Raccomandazione CTI R14:2013
- [2] OIB Guideline 6: Energieeinsparung und Wärmeschutz. Österreichisches Institut für Bautechnik. OIB-330.6-094/11. Wien, October 2011.

Thermal comfort

- [3] ASHRAE Standard 55-2004: Thermal Environmental Conditions for Human Occupancy. American Society of Heating, Refrigerating and Air-Conditioning Engineers Inc., Atlanta, 2004.
- [4] DIN EN ISO 7726:2002-04 Ergonomics of the thermal environment - Instruments for measuring physical quantities. Beuth Verlag, Berlin.
- [5] CEN/CR 1752: Ventilation for buildings—Design criteria for the indoor environment. European Committee for Standardization, 2001.
- [6] DIN EN ISO 11079:2007-12 (2007) Ergonomics of the thermal environment - Determination and interpretation of cold stress when using required clothing insulation (IREQ) and local cooling effects. Beuth Verlag GmbH, Berlin.
- [7] EN 15251:2007-08 (2007) Criteria for the indoor environment. Beuth Verlag GmbH, Berlin.
- [8] EN ISO 7730:2005 (2005) Ergonomics of the thermal environment - Analytical determination and interpretation of thermal comfort using calculation of the PMV and PPD indices and local thermal comfort criteria. Beuth Verlag GmbH, Berlin.
- [9] Verordnung über energiesparenden Wärmeschutz und energiesparende Anlagentechnik bei Gebäuden (Energieeinsparverordnung – EnEV. Date of issue 2007-07-24 last amended by Article 1 on 2013-11-18.
- [10] DIN V 18599: Energetische Bewertung von Gebäuden - Berechnung des Nutz-, End- und Primärenergiebedarfs für Heizung, Kühlung, Lüftung, Trinkwarmwasser und Beleuchtung. Beuth Verlag GmbH, Berlin.
- [11] DIN V 18599-1:2011-12: Energetische Bewertung von Gebäuden - Berechnung des Nutz-, End- und Primärenergiebedarfs für Heizung, Kühlung, Lüftung, Trinkwarmwasser und Beleuchtung – Teil 1: Allgemeine Bilanzierungsverfahren, Begriffe, Zonierung und Bewertung der Energieträger. Beuth Verlag GmbH, Berlin.
- [12] Kalz D, Pfaffert J (2014) Thermal comfort and energy-efficient cooling of nonresidential buildings. Springer Cham Heidelberg New York Dordrecht London. ISBN 978-3-319-04581-8.
- [13] Bundesministerium für Verkehr, Bau und Stadtentwicklung (publisher): Benchmarks für die Energieeffizienz von Nichtwohngebäuden - Vergleichswerte für Energieausweise. BBSR-Online-Publikation, Nr. 09/2009. Berlin, March 2009

Lighting

- [14] DIN 5034-1 : 2011-7 Tageslicht in Innenräumen — Teil 1: Allgemeine Anforderungen. Beuth Verlag GmbH, Berlin.
- [15] DIN 5034-3 : 2007-2 Tageslicht in Innenräumen — Teil 3: Berechnung. Beuth Verlag GmbH, Berlin.
- [16] DIN V 18599-4 : 2011-12] Energetische Bewertung von Gebäuden - Teil 4: Nutz- und Endenergiebedarf für Beleuchtung. Beuth Verlag GmbH, Berlin.
- [17] Jakobiak, R.; Denkmalgerechte energetische Sanierung der Friedrich Fröbel Schule in Olbersdorf, Berichtsteil zur Beleuchtung; Berlin, 08.02.2013.
- [18] Voss, K.; Löhnert, G.; Wagner, A.; SolarBau:Monitor - Energieeffizienz und Solarenergienutzung im Nichtwohnungsbau - Konzepte und Bauten; Bezug: BINE Informationsdienst (Redaktion), FIZ Karlsruhe – Leibnitz-Institut für Informationsinfrastruktur GmbH (Hrsg.); Karlsruhe 2001

Modernization of Box Type Windows

- [19] Brandl, D., Mach, T., Grobbauer, M., Ruisinger, U., Hochenauer, C., Analysis of Natural Convection and Heat Transfer for Traditional Box Type Windows, International Journal on Energy Conversion (ISSN 2281-5295), Vol. 1, N. 6, 2013.
- [20] Brandl, D., Mach, T., Grobbauer, M., Ruisinger, U., Hochenauer, C., Analysis of the thermal behaviour of historical box type windows for renovation concepts with CFD, Sustainable Building Conference 2013 (ISBN 978-3-85125-301-6), pp. 181-194
- [21] Gamerith, H., Höfler, K., Vabitsch, G., Ferk, H., and Reiterer, E., Historische Fenster: Untersuchungskriterien zur Bestimmung der Erhaltungswürdigkeit historischer Fenster. (historical windows: Criteria for the determination of the conservation worthiness of historical windows) Graz, 1997.
- [22] Grobbauer, M., Holper, S., Ruisinger, U., Kautsch, P., Zimmer, S., insitu measurement data belonging to Chapter 3.2: Thermisch-hygrische Ertüchtigung von Kastenfenstern, Austrian research project „denkmalaktiv I“ Nr. 82120, 2013
- [23] Müller, R., Holzfenster: Konstruktion, Schäden, Sanierung, Wartung (wooden windows: structure, damage, renovation, service) (Korr. Nachdr. Köln: Rudolf-Müller, 2011).
- [24] Mach, T., Grobbauer, M., Götzhaber, W., denkmalaktiv I, Sanierung alter, denkmalgeschützter Häuser (refurbishment of old, historical buildings), Austrian research project Nr. 82120, 2013
- [25] Holste, F., Urban, A., Wilken, M., Erhaltung der Kastenfenster durch gezielte Verbesserungsmaßnahmen, Frauenhofer IRB, 1996.
- [26] ANSYS Fluent 14.0. Userguide/Theoryguide.

Internal thermal insulation

- [27] ÖNORM B 8110 Teil 2: Wärmeschutz im Hochbau – Teil 2: Wasserdampfdiffusion und Kondensationsschutz, Ausgabe: 2003-07-01
- [28] Ojanen, T., Viitanen, H., Peuhkuri, R., Lähdesmäki, K., Vinha, Salminen, K.: Mold Growth Modeling of Building Structures Using Sensitivity Classes of Materials in Proceedings of Thermal Performance of the Exterior Envelopes of Whole Buildings XI International Conference in Clearwater Beach, Florida, OakRidge National Laboratory, 2010
- [29] ÖNORM EN 335 Teil 1: Dauerhaftigkeit von Holz und Holzprodukten – Definition der Gefährdungsklassen für einen biologischen Befall, Ausgabe: 2006-10-01
- [30] Viitanen, H., Toratti, T. Makkonen, L., Peuhkuri, R., Ojanen, T., Ruokolainen, L., Räisänen, J.: „Towards modelling of decay risk of wooden materials“ in Eur. J. Wood Prod. (2010) 68: 303–313

Prefabricated façade

- [31] DIN 1946-6 (2009): Raumluftechnik – Teil 6: Lüftung von Wohnungen – Allgemeine Anforderungen, Anforderungen zur Bemessung, Ausführung und Kennzeichnung, Übergabe/Übernahme (Abnahme) und Instandhaltung. Deutsches Institut für Normung e.V., Berlin
- [32] Coydon, F., Duran, M., Dinkel, A., Herkel S. (2013) *Rapid Retrofit Solutions Integrating HVAC into Prefabricated EWIS Systems*, in *CLIMA 2013: 11th REHVA World Congress & 8th International Conference on IAQVEC2013*: Prague.
- [33] Ziegler, M.; Krause, M.; et al. (2012): Thermische und strömungstechnische Simulation einer Fassadendämmung mit integrierter Luftführung für die Bestandssanierung. BauSIM 2012. IBPSA. Berlin, IBPSA.
- [34] Coydon, F.; Dinkel, A.; Kagerer, F.; Herkel, S. (2014): *Monitoring results and optimization of a façade integrated ventilation concept for building retrofit*, in *35th AIVC Conference2014*: Poznań.
- [35] DIN EN 308 (1997): Wärmeaustauscher - Prüfverfahren zur Bestimmung der Leistungskriterien von Luft/Luft- und Luft/Abgas-Wärmerückgewinnungsanlagen. Deutsches Institut für Normung e.V., Berlin

Reuse of ventilation ducts

- [36] IEA & Nordic energy research (2013). Nordic Energy Technology Perspective. Paris/France, OECD/IEA. www.iea.org.
- [37] Maripuu, M.-L. (2009). Demand controlled Ventilation (DCV) systems in commercial buildings: functional requirements on systems and components. Gote-borg/Sweden. School of Electrical and Computer Engineering. Chalmers tekniska högskola.
- [38] Halvarsson, J. (2012). Occupancy Pattern in Office Buildings - Consequences for HVAC system design and operation. Trondheim/Norway. Doctoral Thesis, NTNU.

- [39] Mysen, M. Schild, P. Drangsholt, F. Larsen, B.T. (2011) Conversion from CAV to VAV - a key to upgrade ventilation and reach energy targets in the existing build-ing Stock. Proceedings Roomvent 2011, Paper 142, ISBN:978-82-519-2812-0, June 2011, Trondheim/NORWAY.
- [40] Mysen, M. Aronsen, E. Johansen, B.S. (2014) Conversion to DCV with reuse of ductwork (In Norwegian). Oslo/Norway. SINTEF Fag 15. SINTEF akademiske for-lag. ISBN: 978-82-536-1377-2.
- [41] Mysen M. and Nersveen J. Evaluation of the retrofit measures at Kampen School (In Norwegian). Final report project O9817, Norwegian building and Research Institute, Norway, 29 pages.
- [42] IEA ECBCS. 2003. Annex 36 - CaseStudy Reports ECBCS Bookshop Birmingham. 198 pages, ISBN 0-9542670-6-0.
- [43] Mysen M, Hammer H.L, Nersveen J, Fostervold K.I. 2012. Kampen School - Evaluation of pupils' performance and perceived health and well-being before and after school retrofitting. In: *Proceedings of the 10th International Healthy Buildings Conference 2012*, Australia.
- [44] Haverinen-Shaughnessy U, Moschandreas D.J, Shaughnessy R. J. 2011. Association between substandard classroom ventilation rates and student' academic achievement, *Indoor Air*, 21: 121-131.

PV Panels

- [45] Australia ICOMOS Incorporated. (2013, October). The Burra Charter, The Australia ICOMOS Charter for Places of Cultural Significance 2013. Burwood, Victoria, Australia. Retrieved August 1, 2014, from <http://australia.icomos.org/wp-content/uploads/The-Burra-Charter-2013-Adopted-31.10.2013.pdf>
- [46] Australian PV Association. (2013). *Australian PV Survey Report 2012*.
- [47] Beyond Zero Emissions, Melbourne Energy Institute, The University of Melbourne. (2013). *Zero Carbon Australia Buildings Plan*. Melbourne: Beyond Zero Emissions.
- [48] Chowdhury, S. H., & Amanullah, M. T. (2012). Study on electrical and prospective electricity generation from renewable sources in Australia. *Renewable and Sustainable Energy Reviews*, 16, 6879-6887.
- [49] Energy Matters. (n.d.). *Renewable Energy-Solar Power-Grid connected systems*. Retrieved May 30, 2014, from School solar grant: www.energymatters.com.au/renewable-energy/solar-power/grid-connected-systems/school-solar-grant.php
- [50] Green Power. (2014, March 10). *Green Power Accredited Renewable Energy*. Retrieved May 20, 2014, from News: www.greenpower.gov.au/News/Green-Power-can-increase-your-Green-Star-Points/
- [51] Noone, Ben; Centre for Energy and Environmental Markets. (2013). *PV integration on Australian distribution networks*. literature review, University

- of New South Wales, Australian PV Association, ARENA, Australian Government.
- [52] Photovoltaic Power Systems Programme, International Energy Agency. (2013). *PVPS Annual Report 2013, implementing agreement on photovoltaic power systems*. International Energy Agency.
- [53] Pollard, B. (2013). Solar Retrofit, What are the benefits of retrofitting solar-producing technologies? In R. Hyde, N. Groenhout, F. Barram, & K. Yeang, *Sustainable Retrofitting of Commercial Buildings, Warm Climates* (p. 405). London UK, New York USA: Earthscan from Routledge, Taylor and Francis Group.
- [54] Reed, R., & Wilkinson, S. (2005). The increasing importance of sustainability. *Journal of corporate real estate*, 7(4), 339-350.
- [55] The Centre for a Sustainable Built Environment. (2005). *Best Practice Guidelines for Solar Power Building Projects in Australia*. FACULTY OF THE BUILT ENVIRONMENT UNIVERSITY OF NEW SOUTH WALES.
- [56] The University of New South Wales. (n.d.). *Facilities*. Retrieved May 30, 2014, from Tyree energy technologies building - sustainable energy research: www.facilities.unsw.edu.au/tyree-energy-technologies-building-sustainable-energy-research
- [57] The University of Queensland. (n.d.). *Solar Energy*. Retrieved May 30, 2014, from PV array St. Lucia: www.uq.edu.au
- [58] Trudgill, S. (1990). *Barriers to a Better Environment: What Stops Us Solving Environmental Problems?* London: Bellhaven Press.
- [59] University of Queensland. (2014). *GCI leads Queensland's largest solar power installation*. Retrieved May 29, 2014, from Global Change Institute: www.gci.uq.edu.au/news/gci-leads-queensland-largest-solar-power-installation
- [60] Woollahra Municipal Council. (2012, December 12). Woollahra Heritage Conservation Area, Development Control Plan 2003. Sydney, NSW, Australia. Retrieved August 1, 2014, from http://www.woollahra.nsw.gov.au/_data/assets/pdf_file/0013/104008/Woollahra_HCA_DCP_Amendment_1.pdf

Annex A: Boundary conditions of calculation

As far as possible the correct values characterizing the case study buildings were used to calculate the parameters. Partly, however, there was no information available about the correct value; therefore an assumption had to be made. Table 41 provides an overview of scheduled default values.

The daylight factor was calculated with a simplified model that was generated automatically from the room description. The space was modeled as a simple shoebox with averaged dimensions for depth, width and height. Projections and recesses or a non-rectangular shape were ignored. In most cases, however, the shoe box model did correspond to the actual shape of the room. The windows were modeled in their actual size. The thickness of the window wall including all layers of insulation was also modeled correctly. The window location was modeled correctly regarding the height. In the horizontal direction, the windows were evenly distributed across the facade. The room was simulated using the Radiance computer program. The properties of windows and glazing as well as the obstruction were not modeled but considered as correction factors. In case studies, where the daylight factor had been measured, the measured value was used. The obstruction was considered as a correction factor dependent on a previously determined category of obstruction. The value given for the different categories is shown in Table 41.

Table 41: In the case, that parameters could not been determined from project-related information, the listed values were used.

Component	Variable	Unit	value
floor	reflectance	[-]	0,2
wall	reflectance	[-]	0,5
ceiling	reflectance	[-]	0,7
obstruction	reflectance	[-]	0,3
minor obstruction	correction factor	[-]	0,9
typical obstruction	correction factor	[-]	0,7
significant obstruction	correction factor	[-]	0,5
heavy obstruction	correction factor	[-]	0,3
single glazing, float glass	visible transmission	[-]	0,9
double glazing, float glass	visible transmission	[-]	0,82
double glazing, low-E	visible transmission	[-]	0,78

In some case studies there was no information about the light transmittance before renovation, but the type of glazing was known. In these cases, the light transmittance was assumed as specified in Table 41. For the situation after renovation the light transmittance in most cases was known.

Annex B: Calculation Methodology for the *effective window area*

The assessment of the efficiency of the window system to pass daylight to the interior before and after renovation was based on the metric "*effective window area*". This metric allows to identify which measures of renovation did affect the transparency of the window system.

The effective window area described in Equation 2 summarizes the window area with all related reduction factors in a single parameter. By relating the *effective window area* to the floor space, a limited comparison of this ratio across different buildings and rooms is possible.

Table 42 shows the factors used to determine *the effective window area*, most of them defined in [DIN 5034-3: 2007-2]. This standard refers to the gross area of the window A_F and correction factors. The glass area A_G and the effective window area $A_{F,eff}$ are not used in this standard. The reduction factor k_e is defined in [DIN 5034-6: 2007-2], this reduction factor quantifies the light-reducing effect of a light shaft and therefore allows to account for the thickness of the wall. Due to the insulation of the wall the thickness of the window wall may change when renovating a building.

The obstruction was not considered when determining the effective window area in this work. The framework of the effective window area in principle allows the inclusion of a reduction factor for obstruction. There are several reasons not to consider the obstruction here. With respect to the impact of the renovation of the facade on daylighting, the change of the obstruction is an external factor. A building obstructing the facade could have been built or demolished during the period of refurbishment. This would greatly affect effective window area, without being linked to the actually edited question. A second reason not to consider the obstruction consists simply in the absence of the information necessary to calculate a reduction factor for obstruction. A third reason is, that for determining a reduction factor for obstruction a sky model needs to be specified, however the *effective window area* otherwise is independent from a concrete sky model.

Table 42: Parameters for window area

	Symbol	Unit
opening area (gross)	A_F	m ²
reduction factor of the frame	k_1	-
glazing area	A_G	m ²
visible transmission of the glazing	τ_{D65}	-
reduction factor for dirt	k_2	-
reduction factor for light incidence	k_3	-
reduction factor for the thickness of the wall	k_e	-
effective window area	$A_{F,eff}$	m ²
Floor area	A_{NGF}	m ²
effective Window to floor area ratio	$A_{F,eff}/A_{NGF}$	-

The glass area A_G is given by Equation 1 as a product of the gross area of the window A_F and the reduction factor for the framework k_1 . The glass area can also be measured directly.

$$A_G = A_F \cdot k_1 \quad \text{Equation 1}$$

The effective window area $A_{F,eff}$ is calculated according to Equation 2.

$$A_{F,eff} = A_F \cdot \tau_{D65} \cdot k_1 \cdot k_2 \cdot k_3 \cdot k_e$$

Equation 2

with

A_F	window area (gross)
τ_{D65}	visible transmission of the glazing
k_1	reduction factor of the frame
k_2	reduction factor for dirt
k_3	reduction factor for light incidence
k_e	reduction factor for the thickness of the wall